

# 2007 Chevrolet TrailBlazer Owner Manual

<b>Seats and Restraint Systems</b> .....	7	<b>Instrument Panel</b> .....	165
Front Seats .....	8	Instrument Panel Overview .....	168
Rear Seats .....	18	Climate Controls .....	185
Safety Belts .....	20	Warning Lights, Gages, and Indicators .....	195
Child Restraints .....	42	Driver Information Center (DIC) .....	216
Airbag System .....	71	Audio System(s) .....	234
Restraint System Check .....	90		
<b>Features and Controls</b> .....	93	<b>Driving Your Vehicle</b> .....	299
Keys .....	95	Your Driving, the Road, and Your Vehicle .....	300
Doors and Locks .....	100	Towing .....	356
Windows .....	107		
Theft-Deterrent Systems .....	109	<b>Service and Appearance Care</b> .....	379
Starting and Operating Your Vehicle .....	112	Service .....	382
Mirrors .....	132	Fuel .....	384
OnStar® System .....	145	Checking Things Under the Hood .....	390
Universal Home Remote System .....	149	All-Wheel Drive .....	434
Storage Areas .....	160	Rear Axle .....	434
Sunroof .....	164	Four-Wheel Drive .....	435

Front Axle .....	436	<b>Maintenance Schedule .....</b>	<b>513</b>
Bulb Replacement .....	437	Maintenance Schedule .....	514
Windshield Wiper Blade Replacement ...	440	<b>Customer Assistance Information .....</b>	<b>535</b>
Tires .....	443	Customer Assistance and Information ...	536
Appearance Care .....	489	Reporting Safety Defects .....	554
Vehicle Identification .....	499	<b>Index .....</b>	<b>557</b>
Electrical System .....	500		
Capacities and Specifications .....	510		



GENERAL MOTORS, GM, the GM Emblem, CHEVROLET, the CHEVROLET Emblem, and the names TRAILBLAZER and EXT are registered trademarks of General Motors Corporation.

This manual includes the latest information at the time it was printed. We reserve the right to make changes after that time without further notice. For vehicles first sold in Canada, substitute the name "General Motors of Canada Limited" for Chevrolet Motor Division whenever it appears in this manual.

This manual describes features that may be available in this model, but your vehicle may not have all of them. For example, more than one entertainment system may be offered or your vehicle may have been ordered without a front passenger or rear seats.

Keep this manual in the vehicle, so it will be there if it is needed while you are on the road. If the vehicle is sold, leave this manual in the vehicle.

## Canadian Owners

A French language copy of this manual can be obtained from your dealer or from:

Helm, Incorporated  
P.O. Box 07130  
Detroit, MI 48207

Litho in U.S.A.  
Part No. 15863673 A First Printing

©2006 General Motors Corporation. All Rights Reserved.

## How to Use This Manual

Many people read the owner manual from beginning to end when they first receive their new vehicle. If this is done, it can help you learn about the features and controls for the vehicle. Pictures and words work together in the owner manual to explain things.

## Index

A good place to quickly locate information about the vehicle is the Index in the back of the manual. It is an alphabetical list of what is in the manual and the page number where it can be found.

## Safety Warnings and Symbols

There are a number of safety cautions in this book. We use a box and the word CAUTION to tell about things that could hurt you if you were to ignore the warning.

### CAUTION:

**These mean there is something that could hurt you or other people.**

In the caution area, we tell you what the hazard is. Then we tell you what to do to help avoid or reduce the hazard. Please read these cautions. If you do not, you or others could be hurt.

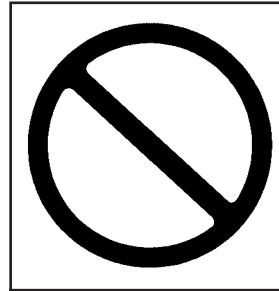

You will also find a circle with a slash through it in this book. This safety symbol means “Do Not,” “Do Not do this” or “Do Not let this happen.”

## Vehicle Damage Warnings

Also, in this manual you will find these notices:

**Notice:** These mean there is something that could damage your vehicle.

A notice tells about something that can damage the vehicle. Many times, this damage would not be covered by your vehicle's warranty, and it could be costly. But the notice will tell what to do to help avoid the damage.

When you read other manuals, you might see CAUTION and NOTICE warnings in different colors or in different words.

There are also warning labels on the vehicle. They use the same words, CAUTION or NOTICE.

































## Vehicle Symbols

The vehicle has components and labels that use symbols instead of text. Symbols are shown along with the text describing the operation or information relating to a specific component, control, message, gage, or indicator.

If you need help figuring out a specific name of a component, gage, or indicator, reference the following topics:

- Seats and Restraint Systems in Section 1
- Features and Controls in Section 2
- Instrument Panel Overview in Section 3
- Climate Controls in Section 3
- Warning Lights, Gages, and Indicators in Section 3
- Audio System(s) in Section 3
- Engine Compartment Overview in Section 5

These are some examples of symbols that may be found on the vehicle:

CAUTION POSSIBLE INJURY		LATCH BOTH LAP AND SHOULDER BELTS TO PROTECT OCCUPANT DO NOT TWIST SAFETY BELT WHEN ATTACHING	 	MASTER LIGHTING SWITCH		ENGINE COOLANT TEMP		TIRE PRESSURE			
PROTECT EYES BY SHIELDING		FASTEN SEAT BELTS		AIRBAG		TURN SIGNALS		BATTERY CHARGING SYSTEM		FUSE BOX ACCESS	
CAUSTIC BATTERY ACID COULD CAUSE BURNS		MOVE SEAT FULLY REARWARD SECURE CHILD SEAT		DO NOT INSTALL A REAR-FACING CHILD RESTRAINT IN THIS SEATING POSITION		PARKING LAMPS		BRAKE		ENGINE COOLANT FAN	
AVOID SPARKS OR FLAMES		PULL BELT OUT COMPLETELY THEN SECURE CHILD SEAT		DO NOT INSTALL A FORWARD-FACING CHILD RESTRAINT IN THIS SEATING POSITION		HAZARD WARNING FLASHER		COOLANT		FUEL	
SPARK OR FLAME COULD EXPLODE BATTERY		POWER WINDOW		DOOR LOCK UNLOCK		DAYTIME RUNNING LAMPS		ENGINE OIL PRESSURE		OWNER MANUAL	
						FOG LAMPS		ANTI-LOCK BRAKE SYSTEM		SERVICE MANUAL	

# Section 1 Seats and Restraint Systems

---

<b>Front Seats</b> .....	8	Child Restraint Systems .....	49
Manual Seats .....	8	Where to Put the Restraint .....	54
Power Seats .....	9	Lower Anchors and Tethers for	
Manual Lumbar .....	10	Children (LATCH) .....	56
Power Lumbar .....	10	Securing a Child Restraint in a	
Heated Seats .....	11	Rear Outside Seat Position .....	63
Memory Seat, Mirrors, and Pedals .....	11	Securing a Child Restraint in the	
Reclining Seatbacks .....	14	Center Rear Seat Position .....	66
Head Restraints .....	17	Securing a Child Restraint in the	
<b>Rear Seats</b> .....	18	Right Front Seat Position .....	66
Rear Seat Operation .....	18	<b>Airbag System</b> .....	71
<b>Safety Belts</b> .....	20	Where Are the Airbags? .....	74
Safety Belts: They Are for Everyone .....	20	When Should an Airbag Inflate? .....	77
Questions and Answers About Safety Belts ....	25	What Makes an Airbag Inflate? .....	79
How to Wear Safety Belts Properly .....	26	How Does an Airbag Restrain? .....	79
Driver Position .....	26	What Will You See After an Airbag Inflates? ...	80
Safety Belt Use During Pregnancy .....	34	Passenger Sensing System .....	82
Right Front Passenger Position .....	35	Servicing Your Airbag-Equipped Vehicle .....	88
Rear Seat Passengers .....	35	Adding Equipment to Your	
Rear Safety Belt Comfort Guides .....	38	Airbag-Equipped Vehicle .....	89
Safety Belt Pretensioners .....	41	<b>Restraint System Check</b> .....	90
Safety Belt Extender .....	41	Checking the Restraint Systems .....	90
<b>Child Restraints</b> .....	42	Replacing Restraint System Parts	
Older Children .....	42	After a Crash .....	91
Infants and Young Children .....	45		

# Front Seats

## Manual Seats

### CAUTION:

**You can lose control of the vehicle if you try to adjust a manual driver's seat while the vehicle is moving. The sudden movement could startle and confuse you, or make you push a pedal when you do not want to. Adjust the driver's seat only when the vehicle is not moving.**

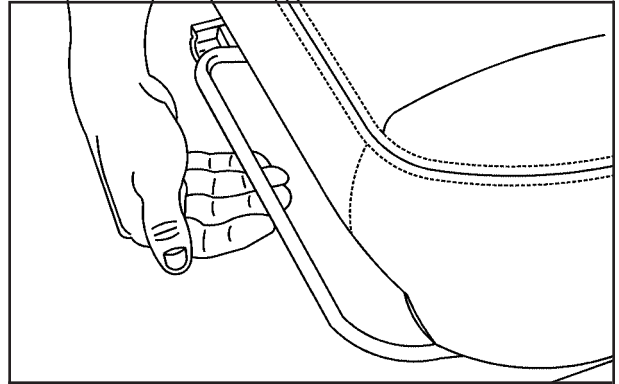

Lift the bar located under the front of the seat to unlock it. Slide the seat to where you want it and release the bar. Try to move the seat with your body to be sure the seat is locked in place.



## Power Seats

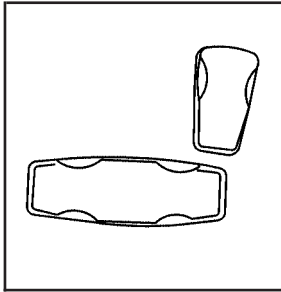

If the vehicle has power seats, the controls used to operate them are located on the outboard side of the seats.

- Raise or lower the rear part of the seat cushion by moving the rear of the horizontal control up or down.
- Raise or lower the entire seat by moving the entire horizontal control up or down.

If the seats have power reclining seatbacks, the control used to operate them is located behind the power seat control on the outboard side of the seats. See “Power Reclining Seatbacks” under *Reclining Seatbacks on page 14*.

To adjust the seat, do any of the following:

- Move the seat forward or rearward by sliding the horizontal control forward or rearward.
- Raise or lower the front part of the seat cushion by moving the front of the horizontal control up or down.

## Manual Lumbar

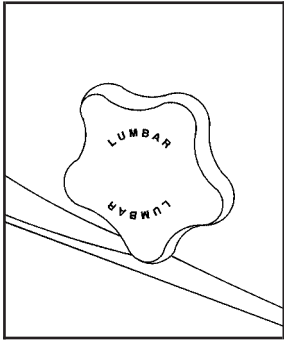

If your vehicle has this feature, there is a knob located on the outboard side of the driver's seat.

Turn the top of the knob toward the front of the vehicle to increase lumbar support. Turn the top of the knob toward the rear of the vehicle to decrease lumbar support.

## Power Lumbar

Your vehicle may have power lumbar on the driver's and front passenger's seats.

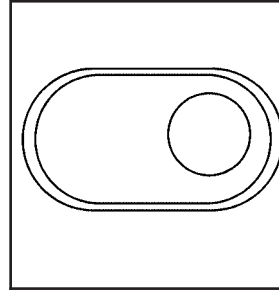

The seatback lumbar support can be adjusted by moving the control located on the outboard side of the seat cushions.

To increase or decrease support, hold the control forward or rearward.

Keep in mind that as your seating position changes, as it may during long trips, so should the position of your lumbar support. Adjust the seat as needed.

## Heated Seats

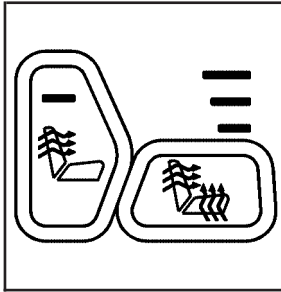

Your vehicle may have heated front seats. The buttons used to control this feature are located on the front door armrests. The engine must be running for the heated seat feature to work.

To heat the entire seat, press the horizontal button with the heated seat and seatback symbol. Press the button to cycle through the temperature settings of high, medium, and low and to turn the heated seat off. The indicator lights above the button will come on to designate the level of heat selected: three for high, two for medium, and one for low. The low setting warms the seatback and seat cushion until the seat temperature is near body temperature. The medium and high settings heat the seatback and seat cushion to a slightly higher temperature. You will be able to feel heat in about two minutes.

To heat only the seatback, press the vertical button with the heated seatback symbol. An indicator light on the button will come on to designate that only the seatback is being heated. Additional presses will cycle through the heat levels for the seatback only.

The feature will shut off automatically when the ignition is turned off.

## Memory Seat, Mirrors, and Pedals

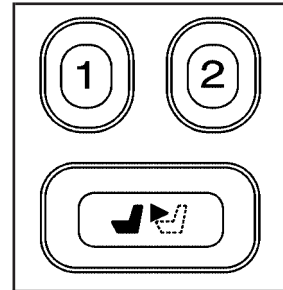

If your vehicle has this feature, the controls for the memory function are located on the driver's door.

These buttons are used to program and recall memory settings for the driver's seating position, both outside mirror positions, and the adjustable pedals, if equipped. The settings for these features can be saved for up to two drivers.

To store the memory settings, do the following:

1. Adjust the driver's seat, including the seatback recliner and lumbar, both of the outside mirrors, and the adjustable pedals, if equipped, to the desired position.

See *Adjustable Throttle and Brake Pedal on page 116* for more information.

2. Press and hold the 1 or 2 button of the memory control for three seconds. A double chime will sound to let you know that the position has been stored.

To repeat the procedure for a second driver, follow the preceding steps, but press the other numbered memory control button.

To recall the memory settings, do one of the following:

- Press and release button 1 or 2 while the vehicle is in PARK (P). A single chime will sound and the memory position will be recalled.
- If programmed to do so through the Driver Information Center (DIC), pressing the unlock button on the remote keyless entry transmitter will recall the preset driver's memory seat, mirrors, and adjustable pedals position. The numbers on the back of the transmitters, 1 or 2, correspond to the numbers on the memory controls.
- If programmed to do so through the DIC, placing the key in the ignition will recall the driver's memory seat, mirrors, and adjustable pedals positions.

See "Seat Recall" under *DIC Vehicle Customization on page 226* for more information.

To stop recall movement of the memory seat feature at any time, press one of the memory buttons or power seat controls.

## Easy Exit Seat

The control for the easy exit seat function is located on the driver's door below the memory buttons 1 and 2. The easy exit seat button is used to program and recall the desired driver's seat position when exiting or entering the vehicle. The mirrors, power lumbar, recline, and adjustable pedals, if equipped, positions will not be stored or recalled when using the easy exit seat function. The seat position can be saved for up to two drivers.

To store the easy exit seat position, do the following:

1. Press and release the 1 or 2 button of the memory control for less than three seconds. The seat will move to the stored memory position.
2. Adjust the seat to the desired exit position.
3. Press and hold the easy exit seat button for more than three seconds. A double chime will sound to let you know that the position has been stored for the selected button 1 or 2.

To repeat the procedure for a second driver, follow the preceding steps, but press the other numbered memory control button.

To recall the easy exit seat position, do one of the following:

- Press the easy exit seat button on the memory control while the vehicle is in PARK (P). The seat will move to the stored exit position.
- Or, if the easy exit seat feature is activated in the Driver Information Center (DIC), removing the key from the ignition will move the seat to the exit position. See "Easy Exit Seat" under *DIC Vehicle Customization on page 226* for more information on activating this feature in the DIC.

If an easy exit seat position has not been stored, the default position is all the way rearward.

## Reclining Seatbacks

### Manual Reclining Seatbacks

#### CAUTION:

**You can lose control of the vehicle if you try to adjust a manual driver's seat while the vehicle is moving. The sudden movement could startle and confuse you, or make you push a pedal when you do not want to. Adjust the driver's seat only when the vehicle is not moving.**

#### CAUTION:

**If the seatback is not locked, it could move forward in a sudden stop or crash. That could cause injury to the person sitting there. Always push and pull on the seatback to be sure it is locked.**

If the seats have manual reclining seatbacks, the lever used to operate them is located on the outboard side of the seat(s).

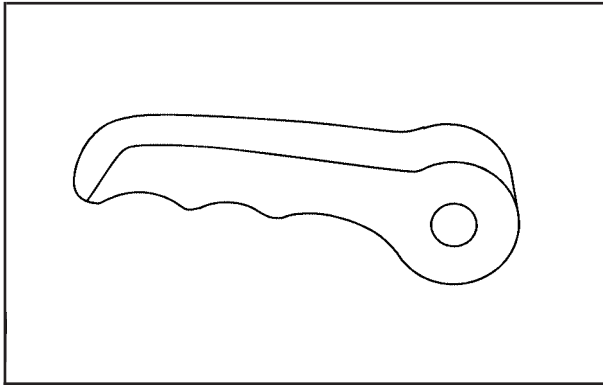

To recline the seatback, do the following:

1. Lift the recline lever.
2. Move the seatback to the desired position, then release the lever to lock the seatback in place.
3. Push and pull on the seatback to make sure it is locked.

To return the seatback to an upright position, do the following:

1. Lift the lever fully without applying pressure to the seatback and the seatback will return to the upright position.
2. Push and pull on the seatback to make sure it is locked.

## Power Reclining Seatbacks

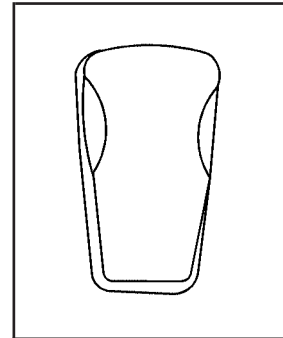

If your seats have power reclining seatbacks, use the vertical power seat control located on the outboard side of the seat(s).

- To recline the seatback, press the control toward the rear of the vehicle.
- To raise the seatback, press the control toward the front of the vehicle.

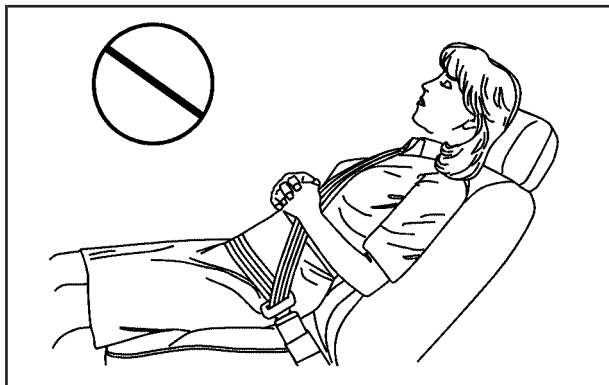

**⚠ CAUTION:**

**Sitting in a reclined position when your vehicle is in motion can be dangerous. Even if you buckle up, your safety belts cannot do their job when you are reclined like this.**

**The shoulder belt cannot do its job. In a crash, you could go into it, receiving neck or other injuries.**

**The lap belt cannot do its job either. In a crash the belt could go up over your abdomen. The belt forces would be there, not at your pelvic bones. This could cause serious internal injuries.**

**For proper protection when the vehicle is in motion, have the seatback upright. Then sit well back in the seat and wear your safety belt properly.**

Do not have a seatback reclined if your vehicle is moving.



## Head Restraints



Adjust the head restraint so that the top of the restraint is at the same height as the top of the occupant's head. This position reduces the chance of a neck injury in a crash.

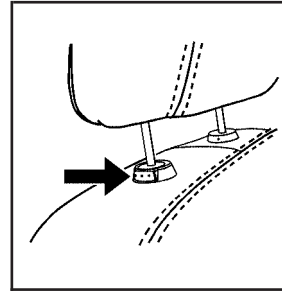

Pull the head restraint up to raise it.

To lower the head restraint, press the button, located on the top of the seatback, and push the head restraint down.

# Rear Seats

## Rear Seat Operation

Your vehicle has flip and fold second row seats which provide additional cargo space.

To flip and fold the seat(s), do the following:

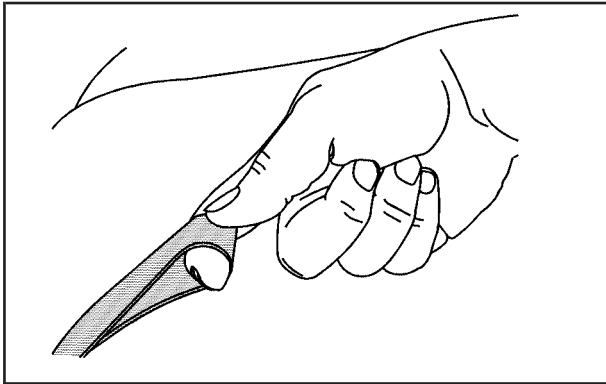

1. Pull up on the loop located where the seat cushion meets the seatback and flip the seat cushion forward.

**Notice:** Folding a rear seat with the safety belts still fastened may cause damage to the seat or the safety belts. Always unbuckle the safety belts and return them to their normal stowed position before folding a rear seat.

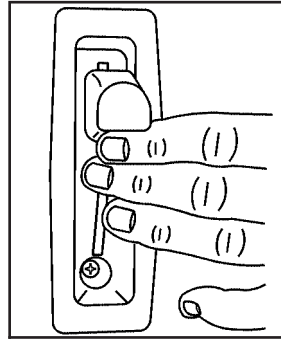

2. Lift the lever, located on the outboard side of the seatback, and fold the seatback forward.

The head restraint will automatically fold out of the way as the seatback is folded down.

To return the seat(s) to the original position, do the following:

**⚠ CAUTION:**

**If the seatback is not locked, it could move forward in a sudden stop or crash. That could cause injury to the person sitting there. Always push and pull on the seatback to be sure it is locked.**

1. Lift the seatback until it locks into the upright position. Push and pull on the seatback to make sure it is locked.

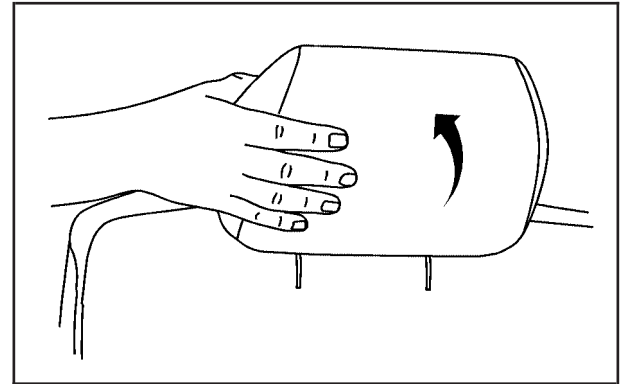

2. Return the head restraints to the upright position by reaching behind the seat and pulling it forward until it locks into place. Push and pull on the head restraint to make sure that it is locked.
3. Flip the seat cushion back into place.

# Safety Belts

## Safety Belts: They Are for Everyone

This part of the manual tells you how to use safety belts properly. It also tells you some things you should not do with safety belts.

### CAUTION:

**Do not let anyone ride where he or she cannot wear a safety belt properly. If you are in a crash and you are not wearing a safety belt, your injuries can be much worse. You can hit things inside the vehicle or be ejected from it. You can be seriously injured or killed. In the same crash, you might not be, if you are buckled up. Always fasten your safety belt, and check that your passengers' belts are fastened properly too.**

 **CAUTION:**

**It is extremely dangerous to ride in a cargo area, inside or outside of a vehicle. In a collision, people riding in these areas are more likely to be seriously injured or killed. Do not allow people to ride in any area of your vehicle that is not equipped with seats and safety belts. Be sure everyone in your vehicle is in a seat and using a safety belt properly.**

Your vehicle has indicators to remind you and your passengers to buckle your safety belts. See *Safety Belt Reminder Light on page 198* and *Passenger Safety Belt Reminder Light on page 198*.

In most states and in all Canadian provinces, the law says to wear safety belts. Here is why:  
*They work.*

You never know if you will be in a crash. If you do have a crash, you do not know if it will be a bad one.

A few crashes are mild, and some crashes can be so serious that even buckled up, a person would not survive. But most crashes are in between. In many of them, people who buckle up can survive and sometimes walk away. Without belts they could have been badly hurt or killed.

After more than 40 years of safety belts in vehicles, the facts are clear. In most crashes buckling up does matter... a lot!

## Why Safety Belts Work

When you ride in or on anything, you go as fast as it goes.

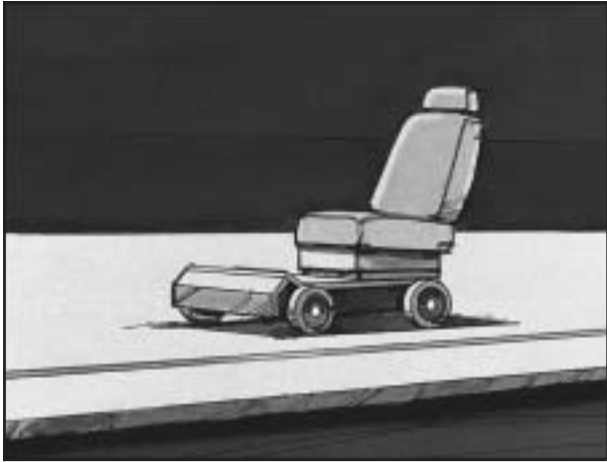

Take the simplest vehicle. Suppose it is just a seat on wheels.



Put someone on it.

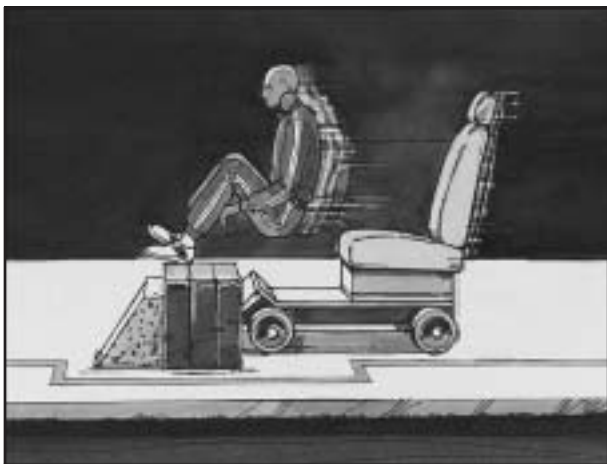

Get it up to speed. Then stop the vehicle. The rider does not stop.



The person keeps going until stopped by something. In a real vehicle, it could be the windshield...



or the instrument panel...



or the safety belts!

With safety belts, you slow down as the vehicle does. You get more time to stop. You stop over more distance, and your strongest bones take the forces. That is why safety belts make such good sense.



## Questions and Answers About Safety Belts

**Q: Will I be trapped in the vehicle after an accident if I am wearing a safety belt?**

**A:** You *could* be — whether you are wearing a safety belt or not. But you can unbuckle a safety belt, even if you are upside down. And your chance of being conscious during and after an accident, so you *can* unbuckle and get out, is *much* greater if you are belted.

**Q: If my vehicle has airbags, why should I have to wear safety belts?**

**A:** Airbags are in many vehicles today and will be in most of them in the future. But they are supplemental systems only; so they work *with* safety belts — not instead of them. Every airbag system ever offered for sale has required the use of safety belts. Even if you are in a vehicle that has airbags, you still have to buckle up to get the most protection. That is true not only in frontal collisions, but especially in side and other collisions.

**Q: If I am a good driver, and I never drive far from home, why should I wear safety belts?**

**A:** You may be an excellent driver, but if you are in an accident — even one that is not your fault — you and your passengers can be hurt. Being a good driver does not protect you from things beyond your control, such as bad drivers.

Most accidents occur within 25 miles (40 km) of home. And the greatest number of serious injuries and deaths occur at speeds of less than 40 mph (65 km/h).

Safety belts are for everyone.

## How to Wear Safety Belts Properly

This part is only for people of adult size.

Be aware that there are special things to know about safety belts and children. And there are different rules for smaller children and babies. If a child will be riding in your vehicle, see *Older Children on page 42* or *Infants and Young Children on page 45*. Follow those rules for everyone's protection.

First, you will want to know which restraint systems your vehicle has.

We will start with the driver position.

## Driver Position

### Lap-Shoulder Belt

The driver has a lap-shoulder belt. Here is how to wear it properly.

1. Close and lock the door.
2. Adjust the seat so you can sit up straight. To see how, see "Seats" in the Index.

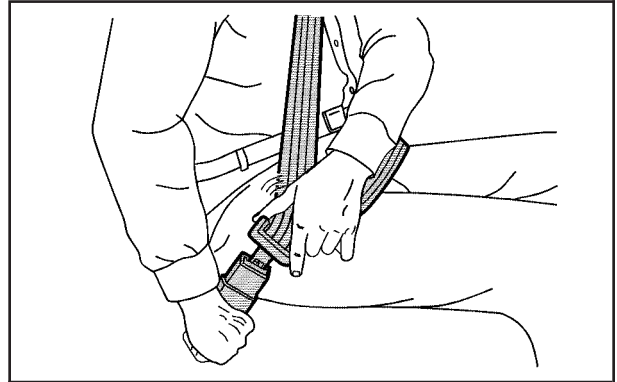

3. Pick up the latch plate and pull the belt across you. Do not let it get twisted.

The lap-shoulder belt may lock if you pull the belt across you very quickly. If this happens, let the belt go back slightly to unlock it.

Then pull the belt across you more slowly.

4. Push the latch plate into the buckle until it clicks.

Pull up on the latch plate to make sure it is secure.

If the belt is not long enough, see *Safety Belt Extender on page 41*.

Make sure the release button on the buckle is positioned so you would be able to unbuckle the safety belt quickly if you ever had to.

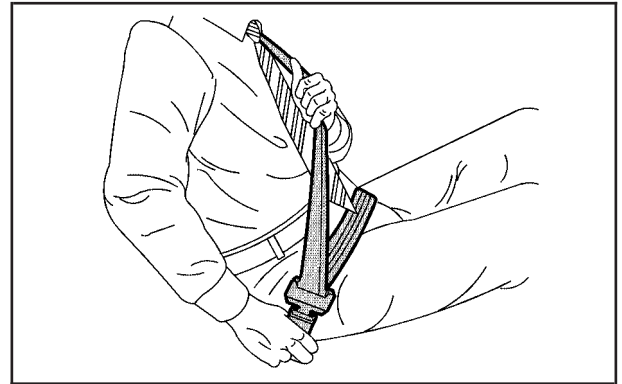

5. To make the lap part tight, pull up on the shoulder belt.

It may be necessary to pull stitching on the safety belt through the latch plate to fully tighten the lap belt on smaller occupants.

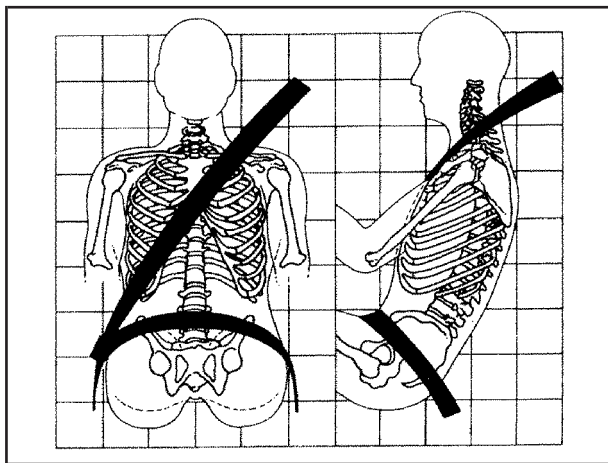

The lap part of the belt should be worn low and snug on the hips, just touching the thighs. In a crash, this applies force to the strong pelvic bones. And you would be less likely to slide under the lap belt. If you slid under it, the belt would apply force at your abdomen. This could cause serious or even fatal injuries. The shoulder belt should go over the shoulder and across the chest. These parts of the body are best able to take belt restraining forces.

The safety belt locks if there is a sudden stop or crash.

**Q:** What is wrong with this?

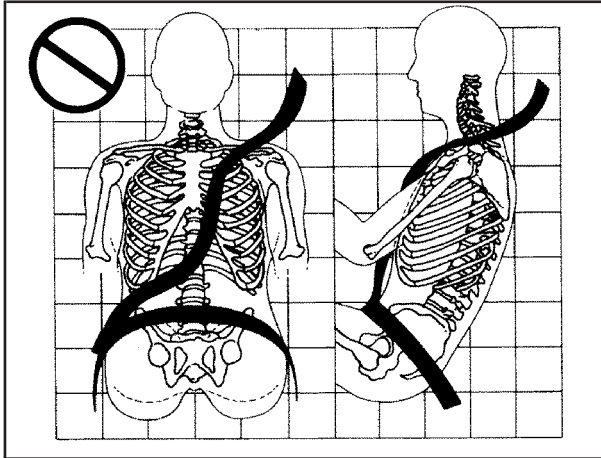

**A:** The shoulder belt is too loose. It will not give nearly as much protection this way.

**⚠ CAUTION:**

You can be seriously hurt if your shoulder belt is too loose. In a crash, you would move forward too much, which could increase injury. The shoulder belt should fit against your body.

**Q:** What is wrong with this?

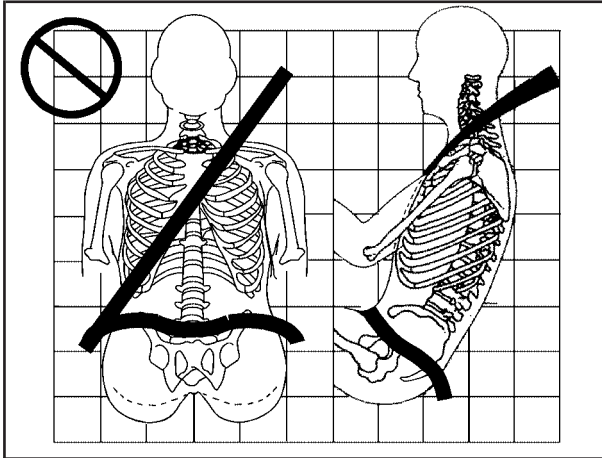

**A:** The lap belt is too loose. It will not give nearly as much protection this way.

**⚠ CAUTION:**

You can be seriously hurt if your lap belt is too loose. In a crash, you could slide under the lap belt and apply force at your abdomen. This could cause serious or even fatal injuries. The lap belt should be worn low and snug on the hips, just touching the thighs.

**Q:** What is wrong with this?

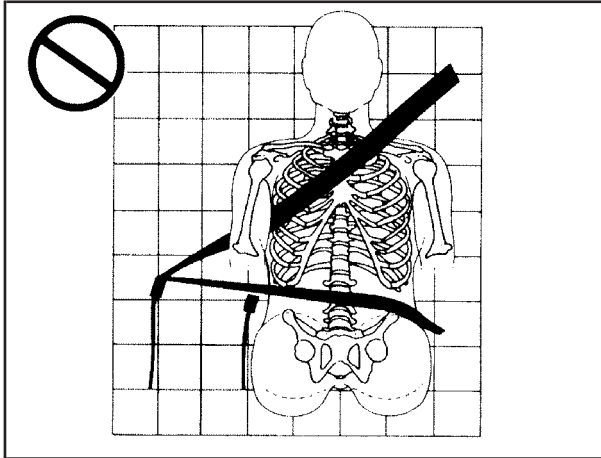

**A:** The belt is buckled in the wrong place.

**⚠ CAUTION:**

You can be seriously injured if your belt is buckled in the wrong place like this. In a crash, the belt would go up over your abdomen. The belt forces would be there, not at the pelvic bones. This could cause serious internal injuries. Always buckle your belt into the buckle nearest you.

**Q:** What is wrong with this?

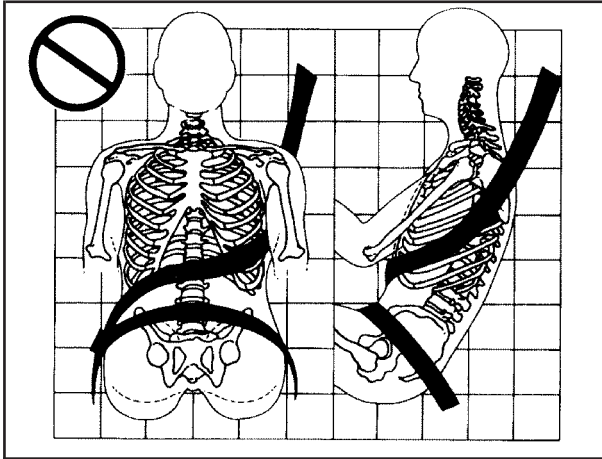

**A:** The shoulder belt is worn under the arm. It should be worn over the shoulder at all times.

**⚠ CAUTION:**

You can be seriously injured if you wear the shoulder belt under your arm. In a crash, your body would move too far forward, which would increase the chance of head and neck injury. Also, the belt would apply too much force to the ribs, which are not as strong as shoulder bones. You could also severely injure internal organs like your liver or spleen.



**Q:** What is wrong with this?

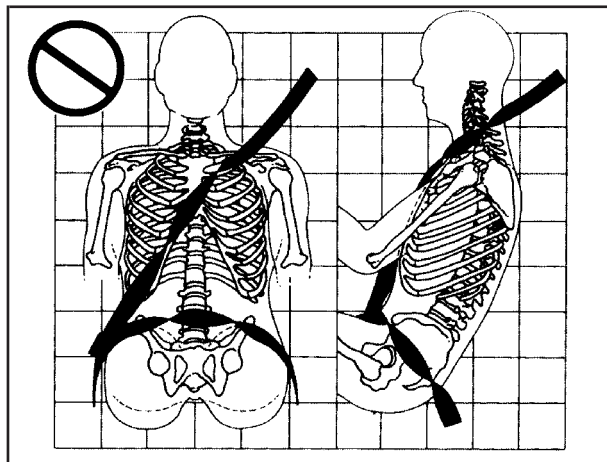

**A:** The belt is twisted across the body.

**⚠ CAUTION:**

You can be seriously injured by a twisted belt. In a crash, you would not have the full width of the belt to spread impact forces. If a belt is twisted, make it straight so it can work properly, or ask your dealer to fix it.

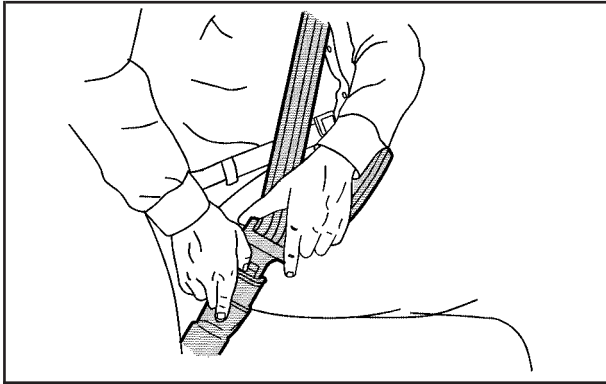

To unfasten the belt, push the button on the buckle. The belt should go back out of the way.

Before you close the door, be sure the belt is out of the way. If you slam the door on it, you can damage both the belt and your vehicle.

## Safety Belt Use During Pregnancy

Safety belts work for everyone, including pregnant women. Like all occupants, they are more likely to be seriously injured if they do not wear safety belts.

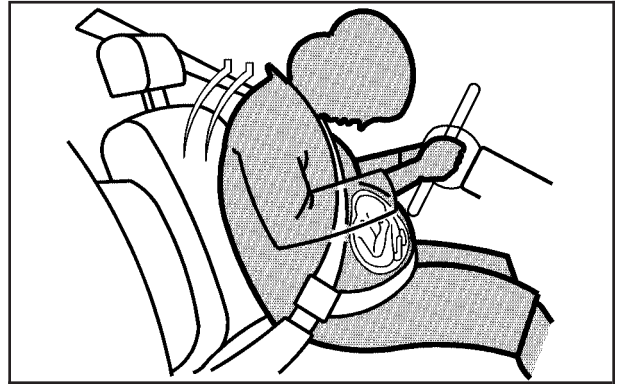

A pregnant woman should wear a lap-shoulder belt, and the lap portion should be worn as low as possible, below the rounding, throughout the pregnancy.

The best way to protect the fetus is to protect the mother. When a safety belt is worn properly, it is more likely that the fetus will not be hurt in a crash. For pregnant women, as for anyone, the key to making safety belts effective is wearing them properly.

## Right Front Passenger Position

To learn how to wear the right front passenger's safety belt properly, see *Driver Position on page 26*.

The right front passenger's safety belt works the same way as the driver's safety belt — except for one thing. If you ever pull the shoulder portion of the belt out all the way, you will engage the child restraint locking feature. If this happens, let the belt go back all the way and start again.

## Rear Seat Passengers

It is very important for rear seat passengers to buckle up! Accident statistics show that unbelted people in the rear seat are hurt more often in crashes than those who are wearing safety belts.

Rear passengers who are not safety belted can be thrown out of the vehicle in a crash. And they can strike others in the vehicle who are wearing safety belts.

## Lap-Shoulder Belt

All rear seat positions have lap-shoulder belts. Here is how to wear one properly.

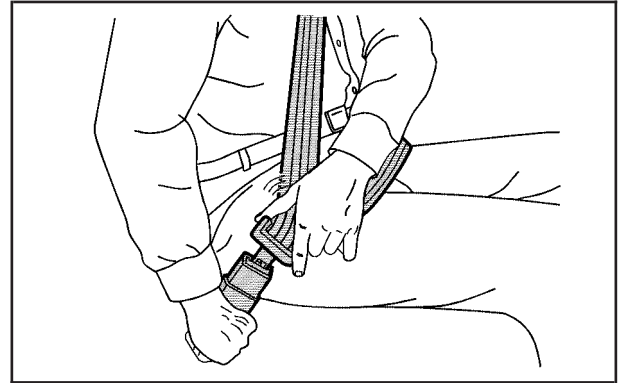

1. Pick up the latch plate and pull the belt across you. Do not let it get twisted.

The shoulder belt may lock if you pull the belt across you very quickly. If this happens, let the belt go back slightly to unlock it. Then pull the belt across you more slowly.

2. Push the latch plate into the buckle until it clicks.

Pull up on the latch plate to make sure it is secure.

When the shoulder belt is pulled out all the way, it will lock. If it does, let it go back all the way and start again.

If the belt is not long enough, see *Safety Belt Extender on page 41*.

Make sure the release button on the buckle is positioned so you would be able to unbuckle the safety belt quickly if you ever had to.

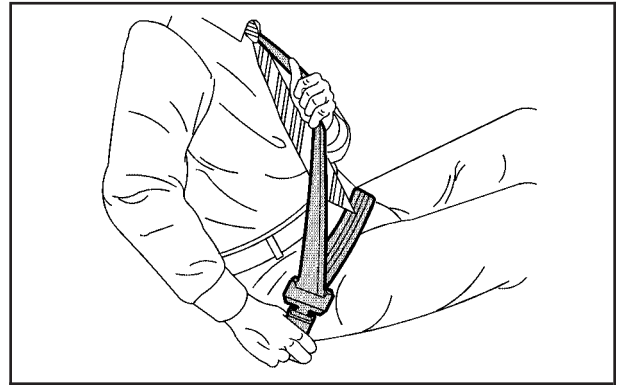

3. To make the lap part tight, pull up on the shoulder part.

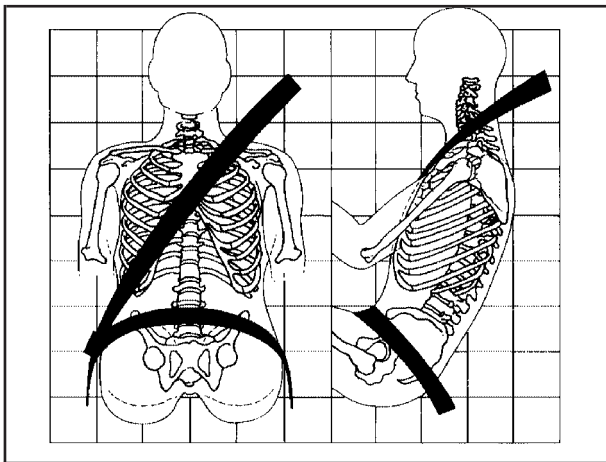

The lap part of the belt should be worn low and snug on the hips, just touching the thighs. In a crash, this applies force to the strong pelvic bones. And you would be less likely to slide under the lap belt. If you slid under it, the belt would apply force at your abdomen. This could cause serious or even fatal injuries.

The shoulder belt should go over the shoulder and across the chest. These parts of the body are best able to take belt restraining forces.

The safety belt locks if there is a sudden stop or a crash, or if you pull the belt very quickly out of the retractor.

**⚠ CAUTION:**

**You can be seriously hurt if your shoulder belt is too loose. In a crash, you would move forward too much, which could increase injury. The shoulder belt should fit against your body.**

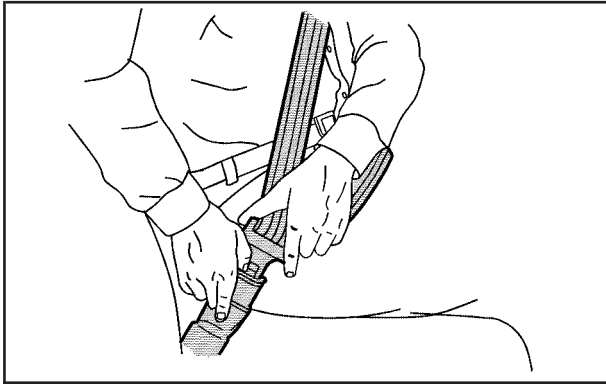

## Rear Safety Belt Comfort Guides

Rear shoulder belt comfort guides may provide added safety belt comfort for older children who have outgrown booster seats and for some adults. When installed on a shoulder belt, the comfort guide positions the belt away from the neck and head.

There is one guide for each outside passenger position in the rear seat. Here is how to install the comfort guide to the shoulder belt:

1. Slide the guide off of its storage clip located between the interior body and the seatback.

To unlatch the belt, push the button on the buckle.

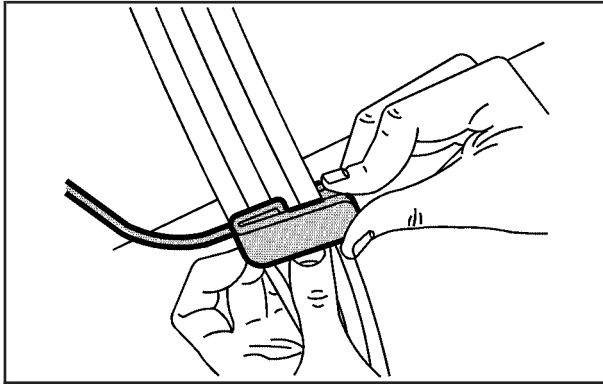

2. Slide the guide under and past the belt. The elastic cord must be under the belt. Then, place the guide over the belt and insert the two edges of the belt into the slots of the guide.

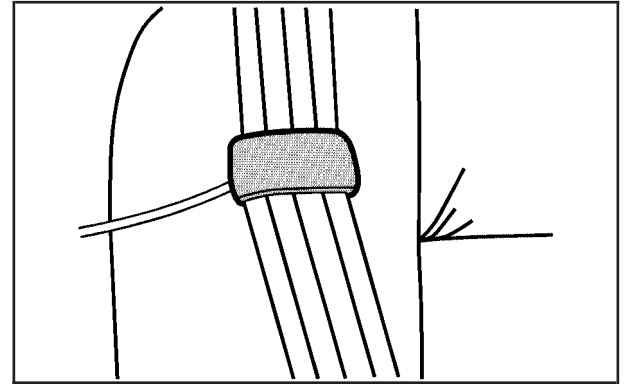

3. Be sure that the belt is not twisted and it lies flat. The elastic cord must be under the belt and the guide on top.

**⚠ CAUTION:**

A safety belt that is not properly worn may not provide the protection needed in a crash. The person wearing the belt could be seriously injured. The shoulder belt should go over the shoulder and across the chest. These parts of the body are best able to take belt restraining forces.

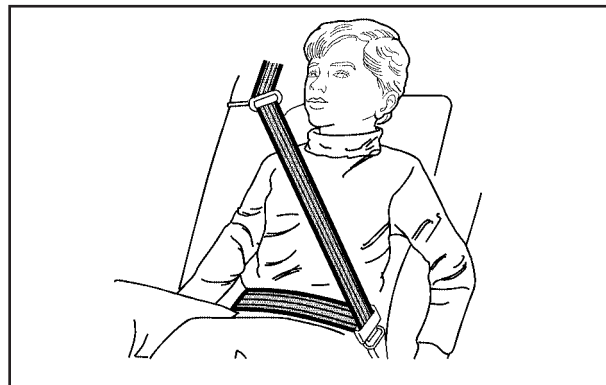

4. Buckle, position, and release the safety belt as described in *Rear Seat Passengers on page 35*. Make sure that the shoulder belt crosses the shoulder.

To remove and store the comfort guide, squeeze the belt edges together so that you can take them out of the guide. Slide the guide back onto its storage clip located between the interior body and the seatback.



## Safety Belt Pretensioners

Your vehicle has safety belt pretensioners for the driver and right front passenger. Although you cannot see them, they are part of the safety belt assembly. They help tighten the safety belts in a moderate to severe frontal or near frontal crash if the threshold conditions for pretensioner activation are met. And, if your vehicle has side impact rollover airbags, safety belt pretensioners can help tighten the safety belts in a side crash or a rollover event.

Pretensioners work only once. If they activate in a crash, you will need to get new ones, and probably other new parts for your safety belt system. See *Replacing Restraint System Parts After a Crash* on page 91.

## Safety Belt Extender

If the vehicle's safety belt will fasten around you, you should use it.

But if a safety belt is not long enough, your dealer will order you an extender. When you go in to order it, take the heaviest coat you will wear, so the extender will be long enough for you. To help avoid personal injury, do not let someone else use it, and use it only for the seat it is made to fit. The extender has been designed for adults. Never use it for securing child seats. To wear it, just attach it to the regular safety belt. For more information see the instruction sheet that comes with the extender.

# Child Restraints

## Older Children

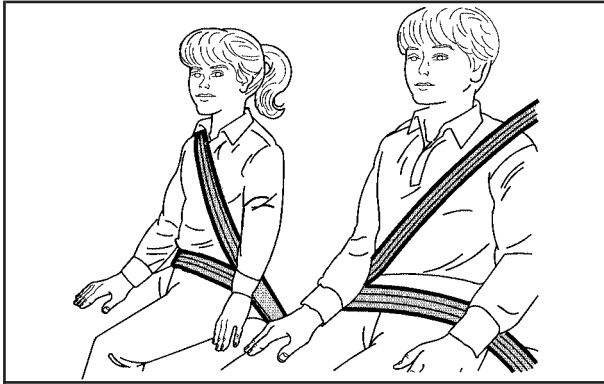

Older children who have outgrown booster seats should wear the vehicle's safety belts.

**Q:** What is the proper way to wear safety belts?

**A:** An older child should wear a lap-shoulder belt and get the additional restraint a shoulder belt can provide. The shoulder belt should not cross the face or neck. The lap belt should fit snugly below the hips, just touching the top of the thighs. It should never be worn over the abdomen, which could cause severe or even fatal internal injuries in a crash.

According to accident statistics, children are safer when properly restrained in the rear seating positions than in the front seating positions.

In a crash, children who are not buckled up can strike other people who are buckled up, or can be thrown out of the vehicle. Older children need to use safety belts properly.



**⚠ CAUTION:**

**Never do this.**

**Here two children are wearing the same belt. The belt can not properly spread the impact forces. In a crash, the two children can be crushed together and seriously injured. A belt must be used by only one person at a time.**

**Q:** What if a child is wearing a lap-shoulder belt, but the child is so small that the shoulder belt is very close to the child's face or neck?

**A:** If the child is sitting in a seat next to a window, move the child toward the center of the vehicle. Also see *Rear Safety Belt Comfort Guides on page 38*. If the child is sitting in the center rear seat passenger position, move the child toward the safety belt buckle. In either case, be sure that the shoulder belt still is on the child's shoulder, so that in a crash the child's upper body would have the restraint that belts provide.



**⚠ CAUTION:**

**Never do this.**

**Here a child is sitting in a seat that has a lap-shoulder belt, but the shoulder part is behind the child. If the child wears the belt in this way, in a crash the child might slide under the belt. The belt's force would then be applied right on the child's abdomen. That could cause serious or fatal injuries.**

Wherever the child sits, the lap portion of the belt should be worn low and snug on the hips, just touching the child's thighs. This applies belt force to the child's pelvic bones in a crash.

## Infants and Young Children

Everyone in a vehicle needs protection! This includes infants and all other children. Neither the distance traveled nor the age and size of the traveler changes the need, for everyone, to use safety restraints. In fact, the law in every state in the United States and in every Canadian province says children up to some age must be restrained while in a vehicle.

### CAUTION:

**Children can be seriously injured or strangled if a shoulder belt is wrapped around their neck and the safety belt continues to tighten. Never leave children unattended in a vehicle and never allow children to play with the safety belts.**

Every time infants and young children ride in vehicles, they should have the protection provided by appropriate restraints. Young children should not use the vehicle's adult safety belts alone, unless there is no other choice. Instead, they need to use a child restraint.

**⚠ CAUTION:**

People should never hold a baby in their arms while riding in a vehicle. A baby does not weigh much — until a crash. During a crash a baby will become so heavy it is not possible to hold it. For example, in a crash at only 25 mph (40 km/h), a 12 lb (5.5 kg) baby will suddenly become a 240 lb (110 kg) force on a person's arms. A baby should be secured in an appropriate restraint.

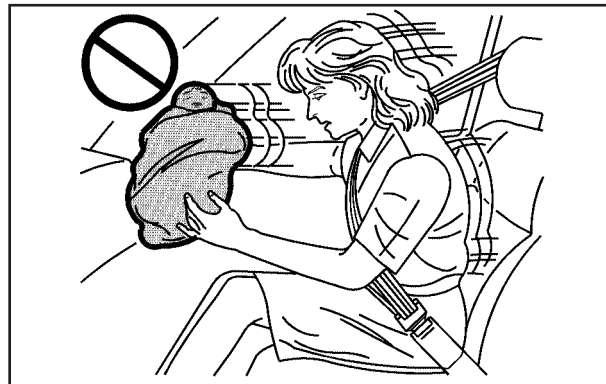

**⚠ CAUTION:**

**Children who are up against, or very close to, any airbag when it inflates can be seriously injured or killed. Airbags plus lap-shoulder belts offer protection for adults and older children, but not for young children and infants. Neither the vehicle's safety belt system nor its airbag system is designed for them. Young children and infants need the protection that a child restraint system can provide.**

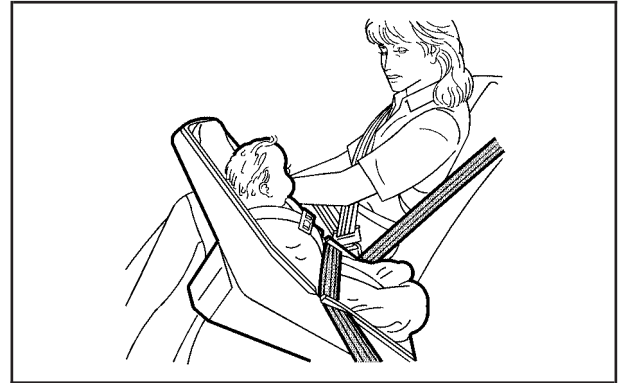

**Q: What are the different types of add-on child restraints?**

**A:** Add-on child restraints, which are purchased by the vehicle's owner, are available in four basic types. Selection of a particular restraint should take into consideration not only the child's weight, height, and age but also whether or not the restraint will be compatible with the motor vehicle in which it will be used.

For most basic types of child restraints, there are many different models available. When purchasing a child restraint, be sure it is designed to be used in a motor vehicle. If it is, the restraint will have a label saying that it meets federal motor vehicle safety standards.

The restraint manufacturer's instructions that come with the restraint state the weight and height limitations for a particular child restraint. In addition, there are many kinds of restraints available for children with special needs.

 **CAUTION:**

**Newborn infants need complete support, including support for the head and neck. This is necessary because a newborn infant's neck is weak and its head weighs so much compared with the rest of its body. In a crash, an infant in a rear-facing seat settles into the restraint, so the crash forces can be distributed across the strongest part of an infant's body, the back and shoulders. Infants always should be secured in appropriate infant restraints.**



**⚠ CAUTION:**

The body structure of a young child is quite unlike that of an adult or older child, for whom the safety belts are designed. A young child's hip bones are still so small that the vehicle's regular safety belt may not remain low on the hip bones, as it should. Instead, it may settle up around the child's abdomen. In a crash, the belt would apply force on a body area that is unprotected by any bony structure. This alone could cause serious or fatal injuries. Young children always should be secured in appropriate child restraints.

## Child Restraint Systems

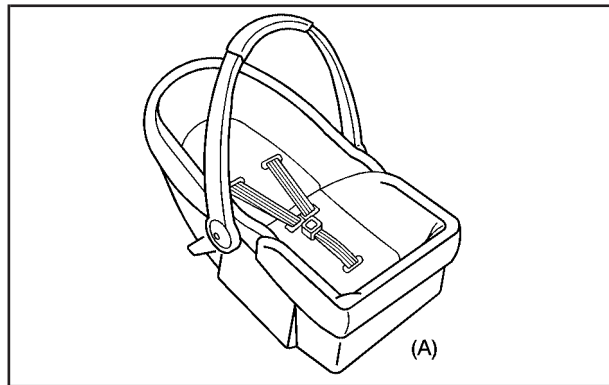

An infant car bed (A), a special bed made for use in a motor vehicle, is an infant restraint system designed to restrain or position a child on a continuous flat surface. Make sure that the infant's head rests toward the center of the vehicle.

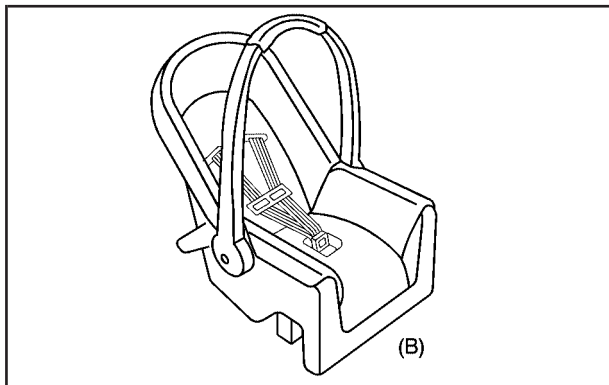

A rear-facing infant seat (B) provides restraint with the seating surface against the back of the infant. The harness system holds the infant in place and, in a crash, acts to keep the infant positioned in the restraint.

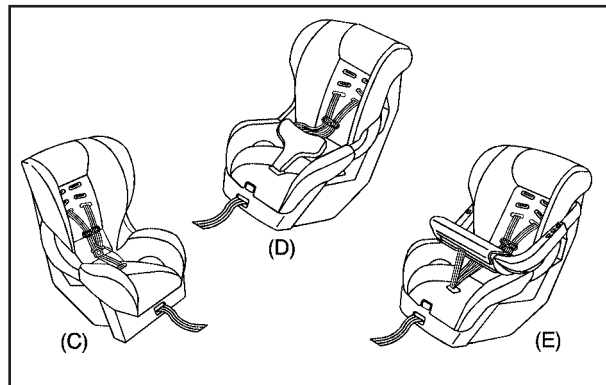

A forward-facing child seat (C-E) provides restraint for the child's body with the harness and also sometimes with surfaces such as T-shaped or shelf-like shields.

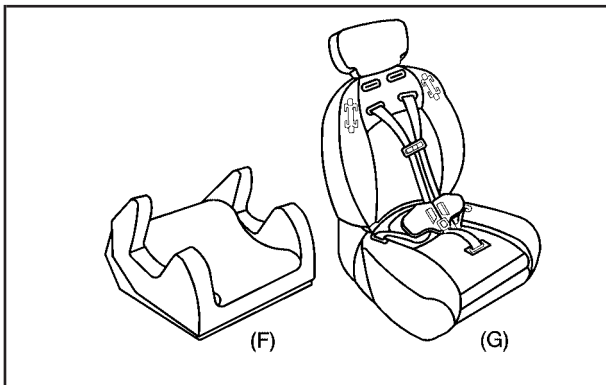

A booster seat (F-G) is a child restraint designed to improve the fit of the vehicle's safety belt system. Some booster seats have a shoulder belt positioner, and some high-back booster seats have a five-point harness. A booster seat can also help a child to see out the window.

## **Q: How Should I Use a Child Restraint?**

**A:** A child restraint system is any device designed for use in a motor vehicle to restrain, seat, or position children. A built-in child restraint system is a permanent part of the motor vehicle. An add-on child restraint system is a portable one, which is purchased by the vehicle's owner. To help reduce injuries, an add-on child restraint must be secured in the vehicle. With built-in or add-on child restraints, the child has to be secured within the child restraint.

When choosing an add-on child restraint, be sure the child restraint is designed to be used in a vehicle. If it is, it will have a label saying that it meets federal motor vehicle safety standards. Then follow the instructions for the restraint. You may find these instructions on the restraint itself or in a booklet, or both.

## Securing an Add-on Child Restraint in the Vehicle

### CAUTION:

**A child can be seriously injured or killed in a crash if the child restraint is not properly secured in the vehicle. Make sure the child restraint is properly installed in the vehicle using the vehicle's safety belt or LATCH system, following the instructions that came with that restraint, and also the instructions in this manual.**

To help reduce the chance of injury, the child restraint must be secured in the vehicle. Child restraint systems must be secured in vehicle seats by lap belts or the lap belt portion of a lap-shoulder belt, or by the LATCH system.

See *Lower Anchors and Tethers for Children (LATCH)* on page 56 for more information. A child can be endangered in a crash if the child restraint is not properly secured in the vehicle.

When securing an add-on child restraint, refer to the instructions that come with the restraint which may be on the restraint itself or in a booklet, or both, and to this manual. The child restraint instructions are important, so if they are not available, obtain a replacement copy from the manufacturer.

Keep in mind that an unsecured child restraint can move around in a collision or sudden stop and injure people in the vehicle. Be sure to properly secure any child restraint in your vehicle — even when no child is in it.

## Securing the Child Within the Child Restraint

There are several systems for securing the child within the child restraint. One system, the three-point harness, has straps that come down over each of the infant's shoulders and buckle together at the crotch. The five-point harness system has two shoulder straps, two hip straps, and a crotch strap. A shield may take the place of hip straps. A T-shaped shield has shoulder straps that are attached to a flat pad which rests low against the child's body. A shelf- or armrest-type shield has straps that are attached to a wide, shelf-like shield that swings up or to the side.

### CAUTION:

**A child can be seriously injured or killed in a crash if the child is not properly secured in the child restraint. Make sure the child is properly secured, following the instructions that came with that restraint.**

Because there are different systems, it is important to refer to the instructions that come with the restraint. A child can be endangered in a crash if the child is not properly secured in the child restraint.

## Where to Put the Restraint

Accident statistics show that children are safer if they are restrained in the rear rather than the front seat. We recommend that child restraints be secured in a rear seat, including an infant riding in a rear-facing infant seat, a child riding in a forward-facing child seat and an older child riding in a booster seat.

If your vehicle has a rear seat that will accommodate a rear-facing child restraint, a label on your sun visor says, "Never put a rear-facing child seat in the front." This is because the risk to the rear-facing child is so great, if the airbag deploys.

### CAUTION:

**A child in a rear-facing child restraint can be seriously injured or killed if the right front passenger's airbag inflates.**

**CAUTION: (Continued)**

### **CAUTION: (Continued)**

**This is because the back of the rear-facing child restraint would be very close to the inflating airbag.**

**Even though the passenger sensing system is designed to turn off the passenger's frontal airbag if the system detects a rear-facing child restraint, no system is fail-safe, and no one can guarantee that an airbag will not deploy under some unusual circumstance, even though it is turned off. We recommend that rear-facing child restraints be secured in the rear seat, even if the airbag is off.**

**If you need to secure a forward-facing child restraint in the right front seat, always move the front passenger seat as far back as it will go. It is better to secure the child restraint in a rear seat.**

If your vehicle does not have a rear seat that will accommodate a rear-facing child restraint, never put a child in a rear-facing child restraint in the right front passenger seat unless the passenger airbag status indicator shows off and the airbag is off. Here is why:

 **CAUTION:**

**A child in a rear-facing child restraint can be seriously injured or killed if the right front passenger's airbag inflates. This is because the back of the rear-facing child restraint would be very close to the inflating airbag. Be sure the airbag is off before using a rear-facing child restraint in the right front seat position.**

**CAUTION: (Continued)**

**CAUTION: (Continued)**

**Even though the passenger sensing system is designed to turn off the passenger's frontal airbag if the system detects a rear-facing child restraint, no system is fail-safe, and no one can guarantee that an airbag will not deploy under some unusual circumstance, even though it is turned off. We recommend that rear-facing child restraints be transported in vehicles with a rear seat that will accommodate a rear-facing child restraint, whenever possible.**

**If you need to secure a forward-facing child restraint in the right front seat, always move the front passenger seat as far back as it will go. It is better to secure the child restraint in a rear seat.**

Wherever you install a child restraint, be sure to secure the child restraint properly.

Keep in mind that an unsecured child restraint can move around in a collision or sudden stop and injure people in the vehicle. Be sure to properly secure any child restraint in your vehicle — even when no child is in it.

## **Lower Anchors and Tethers for Children (LATCH)**

The LATCH system holds a child restraint during driving or in a crash. This system is designed to make installation of a child restraint easier. The LATCH system uses anchors in the vehicle and attachments on the child restraint that are made for use with the LATCH system

Make sure that a LATCH-compatible child restraint is properly installed using the anchors, or use the vehicle's safety belts to secure the restraint, following the instructions that came with that restraint, and also the instructions in this manual.

When installing a child restraint with a top tether, you must also use either the lower anchors or the safety belts to properly secure the child restraint. A child restraint must never be installed using only the top tether and anchor.

In order to use the LATCH system in your vehicle, you need a child restraint that has LATCH attachments. The child restraint manufacturer will provide you with instructions on how to use the child restraint and its attachments. The following explains how to attach a child restraint with these attachments in your vehicle.

Not all vehicle seating positions or child restraints have lower anchors and attachments or top tether anchors and attachments.



## Lower Anchors

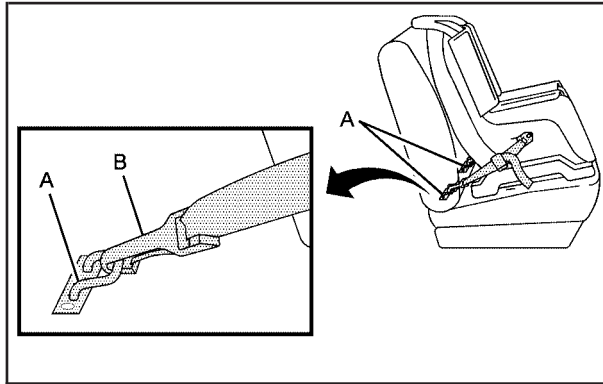

Lower anchors (A) are metal bars built into the vehicle. There are two lower anchors for each LATCH seating position that will accommodate a child restraint with lower attachments (B).

## Top Tether Anchor

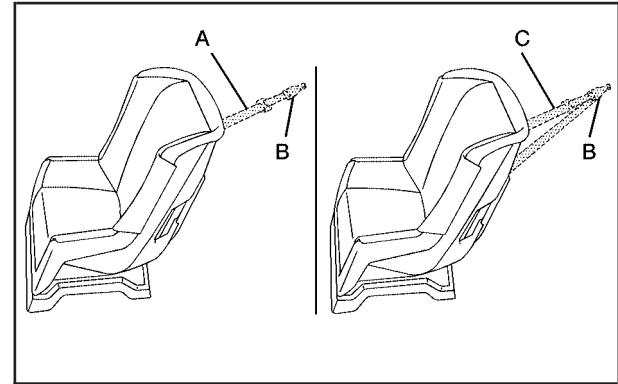

A top tether (A, C) anchors the top of the child restraint to the vehicle. A top tether anchor is built into the vehicle. The top tether attachment (B) on the child restraint connects to the top tether anchor in the vehicle in order to reduce the forward movement and rotation of the child restraint during driving or in a crash.

Your child restraint may have a single tether (A) or a dual tether (C). Either will have a single attachment (B) to secure the top tether to the anchor.

Some child restraints that have a top tether are designed for use with or without the top tether being attached. Others require the top tether always to be attached. In Canada, the law requires that forward-facing child restraints have a top tether, and that the tether be attached. In the United States, some child restraints also have a top tether. Be sure to read and follow the instructions for your child restraint.

If the child restraint does not have a top tether, one can be obtained, in kit form, for many child restraints. Ask the child restraint manufacturer whether or not a kit is available.

## Lower Anchor and Top Tether Anchor Locations

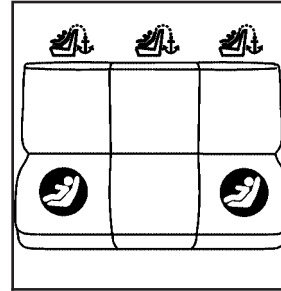

Second Row

 (Top Tether Anchor):  
Seating positions with  
top tether anchors.

 (Lower Anchor):  
Seating positions with  
two lower anchors.

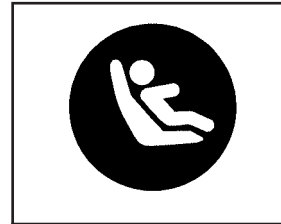

To assist you in locating the lower anchors, each seating position with lower anchors has two labels, near the crease between the seatback and the seat cushion.

The labels are located above a flap, at the base of the seatback, in the rear outside seating positions. The anchors are located under the flap. In order to get to the anchors you will need to pull the strap at the center of the seat where the seat cushion meets the seatback. This will allow you to fold the seat cushion up and out of the way. Lift the flap to expose the anchors and then lower the seat cushion. Be sure the cushion is locked into place.

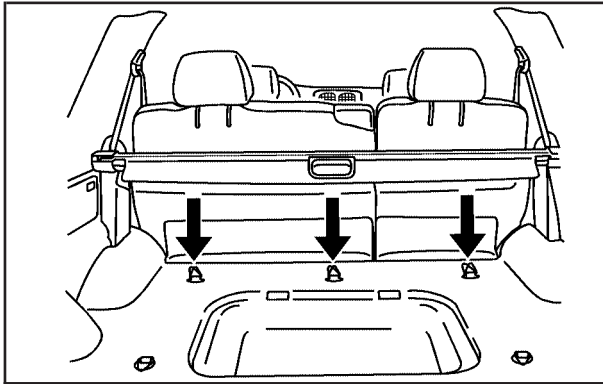

The top tether anchors for each rear seating position are located on the floor in the cargo area of your vehicle. Do not use the rear tie-down brackets near the liftgate for attaching top tethers. Be sure to use an anchor located on the same side of the vehicle as the seating position where the child restraint will be placed.

Do not secure a child restraint in the right front passenger's position, if a national or local law requires that the top tether be attached, or if the instructions that come with the child restraint say that the top tether must be attached. There is no place to attach the top tether in this position.

Accident statistics show that children are safer if they are restrained in the rear rather than the front seat. See *Where to Put the Restraint on page 54* for additional information.

## Securing a Child Restraint Designed for the LATCH System

### CAUTION:

If a LATCH-type child restraint is not attached to anchors, the restraint will not be able to protect the child correctly. In a crash, the child could be seriously injured or killed. Make sure that a LATCH-type child restraint is properly installed using the anchors, or use the vehicle's safety belts to secure the restraint, following the instructions that came with that restraint, and also the instructions in this manual.

### CAUTION:

Each top tether anchor and lower anchor in the vehicle is designed to hold only one child restraint. Attaching more than one child restraint to a single anchor could cause the anchor or attachment to come loose or even break during a crash. A child or others could be injured if this happens. To help prevent injury to people and damage to your vehicle, attach only one child restraint per anchor.

 **CAUTION:**

Children can be seriously injured or strangled if a shoulder belt is wrapped around their neck and the safety belt continues to tighten. Secure any unused safety belts behind the child restraint so children cannot reach them. Pull the shoulder belt all the way out of the retractor to set the lock, if your vehicle has one, after the child restraint has been installed. Be sure to follow the instructions of the child restraint manufacturer.

**Notice:** Contact between the child restraint or the LATCH attachment parts and the vehicle's safety belt assembly may cause damage to these parts. Make sure when securing unused safety belts behind the child restraint that there is no contact between the child restraint or the LATCH attachment parts and the vehicle's safety belt assembly.

**Folding an empty rear seat with the safety belts secured may cause damage to the safety belt or the seat. When removing the child restraint, always remember to return the safety belts to their normal, stowed position before folding the rear seat.**

1. Attach and tighten the lower attachments to the lower anchors. If the child restraint does not have lower attachments or the desired seating position does not have lower anchors, secure the child restraint with the top tether and the safety belts. Refer to your child restraint manufacturer instructions and the instructions in this manual.
  - 1.1. Find the lower anchors for the desired seating position.
  - 1.2. Pull the strap at the center of the seat where the seat cushion meets the seatback. This will allow you to fold the seat cushion up and out of the way. Lift the flap to expose the anchors and then lower the seat cushion. See *Rear Seat Operation on page 18* for additional information. Be sure the cushion is locked into place.

- 1.3. Put the child restraint on the seat.
  - 1.4. Attach and tighten the lower attachments on the child restraint to the lower anchors.
2. If the child restraint manufacturer recommends that the top tether be attached, attach and tighten the top tether to the top tether anchor, if equipped. Refer to the child restraint instructions and the following steps:
- 2.1. Find the top tether anchor.
  - 2.2. Route and tighten the top tether according to your child restraint instructions and the following instructions. If your vehicle has a cargo shade, route the top tether between the seatback and the cargo shade.

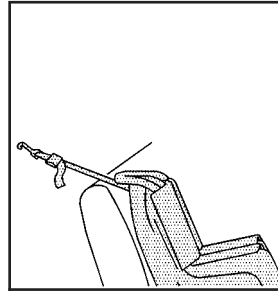

If the position you are using does not have a head restraint and you are using a single tether, route the tether over the seatback.

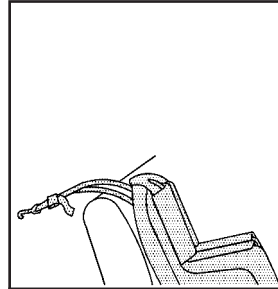

If the position you are using does not have a head restraint and you are using a dual tether, route the tether over the seatback.

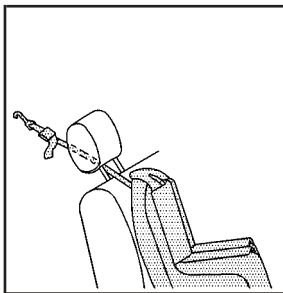

For vehicles that have a head restraint, fold down the head restraint and route the single tether under the head restraint and in between the head restraint posts.

See *Rear Seat Operation* on page 18.

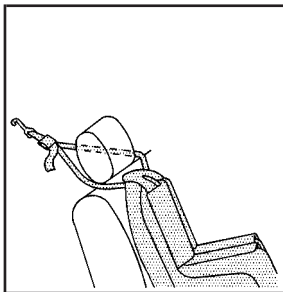

If the position you are using has a head restraint and you are using a dual tether, route the tether around the head restraint.

3. Push and pull the child restraint in different directions to be sure it is secure.

## Securing a Child Restraint in a Rear Outside Seat Position

If your child restraint has the LATCH system, see *Lower Anchors and Tethers for Children (LATCH)* on page 56.

If your child restraint does not have the LATCH system, you will be using the lap-shoulder belt to secure the child restraint in this position. Be sure to follow the instructions that came with the child restraint. Secure the child in the child restraint when and as the instructions say.

1. Put the child restraint on the seat.
2. Pick up the latch plate, and run the lap and shoulder portions of the vehicle's safety belt through or around the restraint. The child restraint instructions will show you how.

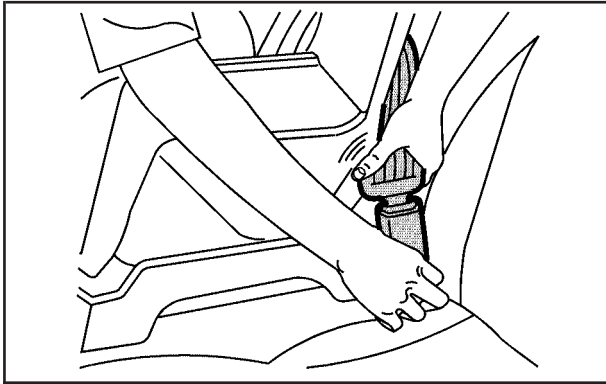

3. Buckle the belt. Make sure the release button is positioned so you would be able to unbuckle the safety belt quickly if you ever had to.

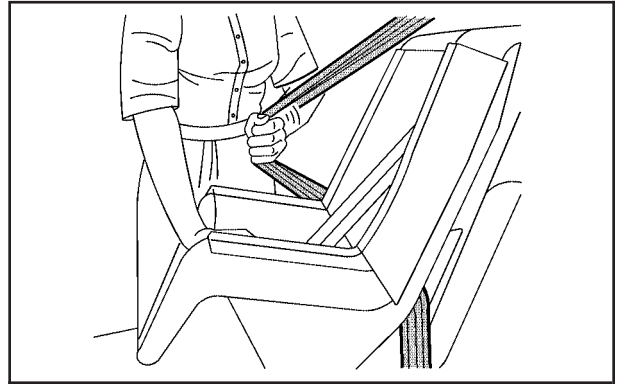

4. Pull the rest of the shoulder belt all the way out of the retractor to set the lock.



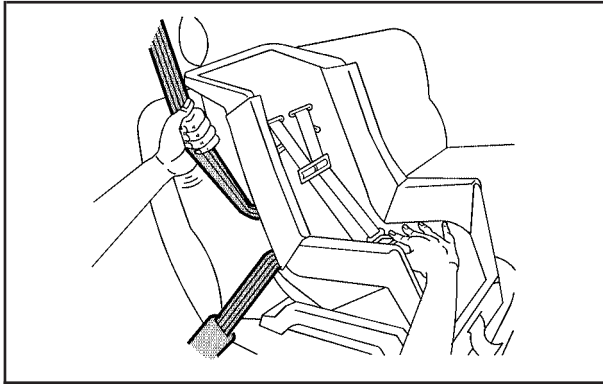

5. To tighten the belt, push down on the child restraint, pull the shoulder portion of the belt to tighten the lap portion of the belt, and feed the shoulder belt back into the retractor. If you are using a forward-facing child restraint, you may find it helpful to use your knee to push down on the child restraint as you tighten the belt.

6. If your child restraint manufacturer recommends using a top tether, attach and tighten the top tether to the top tether anchor. Refer to the instructions that came with the child restraint and to *Lower Anchors and Tethers for Children (LATCH)* on page 56.
7. Push and pull the child restraint in different directions to be sure it is secure.

To remove the child restraint, if the top tether is attached to the top tether anchor, disconnect it. Unbuckle the vehicle's safety belt and let it go back all the way. The safety belt will move freely again and be ready to work for an adult or larger child passenger.

## Securing a Child Restraint in the Center Rear Seat Position

Many child restraints are too wide to be correctly secured in the center rear seat, although some of them will fit there. If the center seat position is too narrow for your child restraint, secure it in a rear outside seat position.

If you secure a child restraint in the center seat position, follow the instructions in *Securing a Child Restraint in a Rear Outside Seat Position* on page 63.

## Securing a Child Restraint in the Right Front Seat Position

Your vehicle has a right front passenger's airbag. A rear seat is a safer place to secure a forward-facing child restraint. See *Where to Put the Restraint* on page 54.

In addition, your vehicle has a passenger sensing system. The passenger sensing system is designed to turn off the right front passenger's frontal airbag when an infant in a rear-facing infant seat or a small child in a forward-facing child restraint or booster seat is detected. See *Passenger Sensing System* on page 82 and *Passenger Airbag Status Indicator* on page 200 for more information on this including important safety information.

A label on your sun visor says, “Never put a rear-facing child seat in the front.” This is because the risk to the rear-facing child is so great, if the airbag deploys.



### **CAUTION:**

**A child in a rear-facing child restraint can be seriously injured or killed if the right front passenger’s airbag inflates. This is because the back of the rear-facing child restraint would be very close to the inflating airbag.**

**Even though the passenger sensing system is designed to turn off the right front passenger’s frontal airbag if the system detects a rear-facing child**

**CAUTION: (Continued)**

### **CAUTION: (Continued)**

**restraint, no system is fail-safe, and no one can guarantee that an airbag will not deploy under some unusual circumstance, even though it is turned off. We recommend that rear-facing child restraints be secured in the rear seat, even if the airbag is off.**

**If you need to secure a forward-facing child restraint in the right front seat, always move the front passenger seat as far back as it will go. It is better to secure the child restraint in a rear seat.**

If you need to secure a forward-facing child restraint in the right front seat position, move the seat as far back as it will go before securing the forward-facing child restraint. See *Manual Seats on page 8* or *Power Seats on page 9*.

If your child restraint has the LATCH system, see *Lower Anchors and Tethers for Children (LATCH)* on page 56.

There is no top tether anchor at the right front seating position. Do not secure a child seat in this position if a national or local law requires that the top tether be anchored or if the instructions that come with the child restraint say that the top tether must be anchored. See *Lower Anchors and Tethers for Children (LATCH)* on page 56 if the child restraint has a top tether.

You will be using the lap-shoulder belt to secure the child restraint in this position. Be sure to follow the instructions that came with the child restraint. Secure the child in the child restraint when and as the instructions say.

1. Your vehicle has a right front passenger's frontal airbag. See *Passenger Sensing System* on page 82. We recommend that rear-facing child restraints be secured in a rear seat, even if the airbag is off. If your child restraint is forward-facing, move the seat as far back as it will go before securing the child restraint in this seat. See *Manual Seats* on page 8 or *Power Seats* on page 9.

When the passenger sensing system has turned off the right front passenger's frontal airbag, the off indicator in the passenger airbag status indicator should light and stay lit when you turn the ignition to RUN or START. See *Passenger Airbag Status Indicator* on page 200.

2. Put the child restraint on the seat.
3. Pick up the latch plate, and run the lap and shoulder portions of the vehicle's safety belt through or around the restraint. The child restraint instructions will show you how.

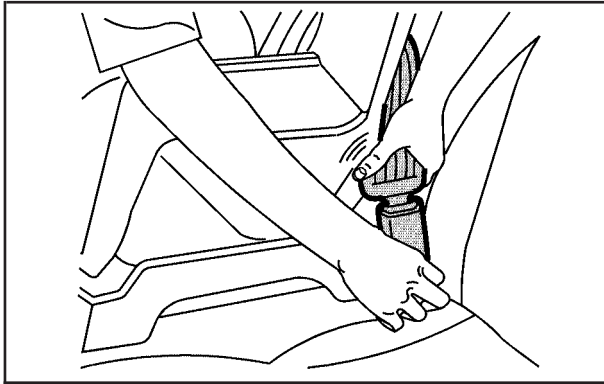

4. Buckle the belt. Make sure the release button is positioned so you would be able to unbuckle the safety belt quickly if you ever had to.

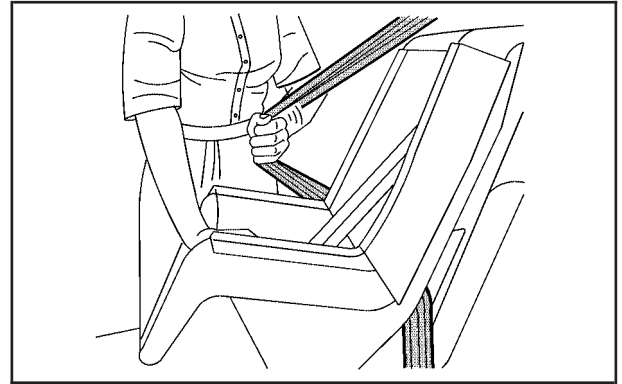

5. Pull the rest of the shoulder belt all the way out of the retractor to set the lock.

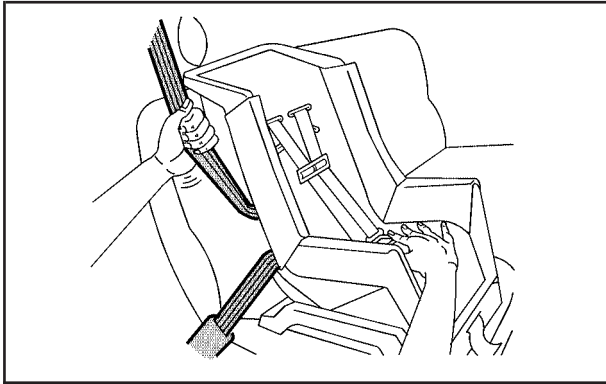

6. To tighten the belt, push down on the child restraint, pull the shoulder portion of the belt to tighten the lap portion of the belt, and feed the shoulder belt back into the retractor. If you are using a forward-facing child restraint, you may find it helpful to use your knee to push down on the child restraint as you tighten the belt. You should not be able to pull more of the belt from the retractor once the lock has been set.

7. Push and pull the child restraint in different directions to be sure it is secure.
8. If the airbag is off, the off indicator will come on and stay on when the key is turned to RUN or START.

If a child restraint has been installed and the on indicator is lit, turn the vehicle off. Remove the child restraint from the vehicle and reinstall the child restraint.

If, after reinstalling the child restraint and restarting the vehicle, the on indicator is still lit, check to make sure that the vehicle's seatback is not pressing the child restraint into the seat cushion. If this happens, slightly recline the vehicle's seatback and adjust the seat cushion if possible. Also make sure the child restraint is not trapped under the vehicle head restraint. If this happens, adjust the head restraint.

If the on indicator is still lit, secure the child in the child restraint in a rear seat position in the vehicle and check with your dealer.

To remove the child restraint, just unbuckle the vehicle's safety belt and let it go back all the way. The safety belt will move freely again and be ready to work for an adult or larger child passenger.

## Airbag System

Your vehicle has a frontal airbag for the driver and a frontal airbag for the right front passenger. Your vehicle may also have roof-mounted side impact airbags designed for either side impact or rollover deployment. Roof-mounted side impact airbags are available for the driver and the passenger seated directly behind the driver and for the right front passenger and the passenger seated directly behind that passenger.

If your vehicle has roof-mounted side impact airbags, the word AIRBAG will appear on the airbag covering on the sidewall trim near the driver's and right front passenger's window.

Even if you have no right front passenger seat in your vehicle there is still an active frontal airbag in the right side of the instrument panel. Do not place cargo in front of this airbag.

### CAUTION:

**Be sure that cargo is not near an airbag. In a crash, an inflating airbag might force that object toward a person. This could cause severe injury or even death. Secure objects away from the area in which an airbag would inflate. For more information, see *Where Are the Airbags?* on page 74 and *Loading Your Vehicle* on page 350.**

Airbags are designed to supplement the protection provided by safety belts. Even though today's airbags are also designed to help reduce the risk of injury from the force of an inflating bag, all airbags must inflate very quickly to do their job.

Here are the most important things to know about the airbag system:

 **CAUTION:**

**You can be severely injured or killed in a crash if you are not wearing your safety belt — even if you have airbags. Wearing your safety belt during a crash helps reduce your chance of hitting things inside the vehicle or being ejected from it. Airbags are “supplemental restraints” to the safety belts. All airbags are designed to work with safety belts but do not replace them.**

**Frontal airbags for the driver and right front passenger are designed to deploy in moderate to severe frontal and near frontal crashes. They are not designed to**

**CAUTION: (Continued)**

**CAUTION: (Continued)**

**inflate in rollover, rear crashes, or in many side crashes. And, for some unrestrained occupants, frontal airbags may provide less protection in frontal crashes than more forceful airbags have provided in the past.**

**Roof-mounted side impact airbags are designed to inflate in moderate to severe crashes where something hits the side of your vehicle. They are not designed to inflate in frontal or in rear crashes. If the vehicle is equipped with rollover capable airbags, it has been designed to deploy the roof-mounted side impact airbags in the event of a vehicle rollover. Everyone in your vehicle should wear a safety belt properly — whether or not there is an airbag for that person.**



 **CAUTION:**

Both frontal and roof-mounted side impact airbags inflate with great force, faster than the blink of an eye. If you are too close to an inflating airbag, as you would be if you were leaning forward, it could seriously injure you. Safety belts help keep you in position for airbag inflation before and during a crash. Always wear your safety belt even with frontal airbags. The driver should sit as far back as possible while still maintaining control of the vehicle. Occupants should not lean on or sleep against the door.

 **CAUTION:**

Anyone who is up against, or very close to, any airbag when it inflates can be seriously injured or killed. Airbags plus lap-shoulder belts offer the best protection for adults, but not for young children and infants. Neither the vehicle's safety belt system nor its airbag system is designed for them. Young children and infants need the protection that a child restraint system can provide. Always secure children properly in your vehicle. To read how, see *Older Children on page 42* or *Infants and Young Children on page 45*.



There is an airbag readiness light on the instrument panel cluster, which shows the airbag symbol.

The system checks the airbag electrical system for malfunctions. The light tells you if there is an electrical problem. See *Airbag Readiness Light on page 199* for more information.

## Where Are the Airbags?



The driver's frontal airbag is in the middle of the steering wheel.



The right front passenger's frontal airbag is in the instrument panel on the passenger's side.



If your vehicle has a roof-mounted airbag for the driver and the person seated directly behind the driver, it is located in the ceiling above the side windows.



If your vehicle has a roof-mounted airbag for the right front passenger and the person directly behind that passenger, it is located in the ceiling above the side windows.

## CAUTION:

If something is between an occupant and an airbag, the bag might not inflate properly or it might force the object into that person causing severe injury or even death. The path of an inflating airbag must be kept clear. Do not put anything between an occupant and an airbag, and do not attach or put anything on the steering wheel hub or on or near any other airbag covering. And, if your vehicle has roof-mounted side impact airbags, never secure anything to the roof of your vehicle by routing the rope or tie down through any door or window opening. If you do, the path of an inflating side impact airbag will be blocked. The path of an inflating airbag must be kept clear.

## When Should an Airbag Inflate?

The driver's and right front passenger's frontal airbags are designed to inflate in moderate to severe frontal or near-frontal crashes. But they are designed to inflate only if the impact exceeds a predetermined deployment threshold. Deployment thresholds take into account a variety of desired deployment and non-deployment events and are used to predict how severe a crash is likely to be in time for the airbags to inflate and help restrain the occupants. Whether your frontal airbags will or should deploy is not based on how fast your vehicle is traveling. It depends largely on what you hit, the direction of the impact, and how quickly your vehicle slows down.

In addition, your vehicle has "dual stage" frontal airbags, which adjust the restraint according to crash severity. Your vehicle has electronic frontal sensors, which helps the sensing system distinguish between a moderate frontal impact and a more severe frontal impact. For moderate frontal impacts, these airbags inflate at a level less than full deployment. For more severe frontal impacts, full deployment occurs.

If the front of your vehicle goes straight into a wall that does not move or deform, the threshold level for the reduced deployment is about 9 to 16 mph (14 to 26 km/h), and the threshold level for a full deployment is about 18 to 25 mph (29 to 40 km/h). The threshold level can vary, however, with specific vehicle design, so that it can be somewhat above or below this range.

Frontal airbags may inflate at different crash speeds. For example:

- If the vehicle hits a stationary object, the airbags could inflate at a different crash speed than if the vehicle hits a moving object.
- If the vehicle hits an object that deforms, the airbags could inflate at a different crash speed than if the vehicle hits an object that does not deform.
- If the vehicle hits a narrow object (like a pole), the airbags could inflate at a different crash speed than if the vehicle hits a wide object (like a wall).
- If the vehicle goes into an object at an angle, the airbags could inflate at a different crash speed than if the vehicle goes straight into the object.

Frontal airbags (driver and right front passenger) are not intended to inflate during vehicle rollovers, rear impacts, or in many side impacts.

Your vehicle has seat position sensors which enables the sensing system to monitor the position of the driver's seat and the right front passenger's seat. Seat position sensors provide information that is used to determine if the airbags should deploy at a reduced level or at full deployment.

Your vehicle may or may not have roof-mounted airbags and a rollover sensor. See *Airbag System on page 71*. These "rollover capable" airbags are intended to inflate in moderate to severe side crashes or during a rollover. A roof-mounted airbag will inflate if the crash severity is above the system's designed "threshold level." The threshold level can vary with specific vehicle design. Roof-mounted airbags are not intended to inflate in frontal or near-frontal impacts, or rear impacts. Both roof-mounted airbags will deploy when either side of the vehicle is struck or during a rollover.

In any particular crash, no one can say whether an airbag should have inflated simply because of the damage to a vehicle or because of what the repair costs were. For frontal airbags, inflation is determined by what the vehicle hits, the angle of the impact, and how quickly the vehicle slows down. For roof-mounted airbags, inflation is determined by the location and severity of the impact.

The airbag system is designed to work properly under a wide range of conditions, including off-road usage. Observe safe driving speeds, especially on rough terrain. As always, wear your safety belt. See *Off-Road Driving (Except SS) on page 317* for tips on off-road driving.

## What Makes an Airbag Inflate?

In an impact of sufficient severity, the airbag sensing system detects that the vehicle is in a crash. Additionally, in the case of a “rollover capable” roof-mounted side impact airbag, the sensing system detects that the vehicle is about to roll over. The sensing system triggers a release of gas from the inflator, which inflates the airbag. The inflator, airbag, and related hardware are all part of the airbag modules inside the steering wheel and in the instrument panel in front of the right front passenger. For vehicles with roof-mounted rollover airbags, the airbag modules, the inflator, and the airbags are located in the ceiling of the vehicle, near the side windows.

## How Does an Airbag Restrain?

In moderate to severe frontal or near frontal collisions, even belted occupants can contact the steering wheel or the instrument panel. In moderate to severe side collisions, even belted occupants can contact the inside of the vehicle. Airbags supplement the protection provided by safety belts. Airbags distribute the force of the impact more evenly over the occupant’s upper body, stopping the occupant more gradually. But the frontal airbags would not help you in many types of collisions, including rollovers, rear impacts, and many side impacts, primarily because an occupant’s motion is not toward the airbag. Roof-mounted rollover airbags would not help you in many types of collisions, including many frontal or near frontal collisions, and rear impacts.

Airbags should never be regarded as anything more than a supplement to safety belts, and then only in moderate to severe frontal or near-frontal collisions for the driver’s and right front passenger’s frontal airbags, and only in moderate to severe side collisions or rollovers for vehicles with roof-mounted rollover airbags.

## What Will You See After an Airbag Inflates?

After a frontal airbag inflates, it quickly deflates, so quickly that some people may not even realize an airbag inflated. Roof-mounted rollover airbags may still be at least partially inflated minutes after the vehicle comes to rest. Some components of the airbag module — the steering wheel hub for the driver's airbag, the instrument panel for the right front passenger's airbag, and the area along the ceiling of the vehicle near the side windows for vehicles with roof-mounted side impact airbags — may be hot for a short time. The parts of the airbag that come into contact with you may be warm, but not too hot to touch. There may be some smoke and dust coming from the vents in the deflated airbags. Airbag inflation does not prevent the driver from seeing out of the windshield or being able to steer the vehicle, nor does it prevent people from leaving the vehicle.

### CAUTION:

**When an airbag inflates, there may be dust in the air. This dust could cause breathing problems for people with a history of asthma or other breathing trouble. To avoid this, everyone in the vehicle should get out as soon as it is safe to do so. If you have breathing problems but cannot get out of the vehicle after an airbag inflates, then get fresh air by opening a window or a door. If you experience breathing problems following an airbag deployment, you should seek medical attention.**



Your vehicle has a feature that may automatically unlock the doors, turn the interior lamps on, and flash the hazard warning flashers when the airbags inflate. You can lock the doors again, turn the interior lamps off, and turn off the hazard warning flashers by using the controls for those features.

In many crashes severe enough to inflate the airbag, windshields are broken by vehicle deformation. Additional windshield breakage may also occur from the right front passenger airbag.

- Airbags are designed to inflate only once. After an airbag inflates, you will need some new parts for your airbag system. If you do not get them, the airbag system will not be there to help protect you in another crash. A new system will include airbag modules and possibly other parts. The service manual for your vehicle covers the need to replace other parts.

- Your vehicle has a crash sensing and diagnostic module which records information after a crash. See *Vehicle Data Collection and Event Data Recorders* on page 548.
- Let only qualified technicians work on the airbag system. Improper service can mean that an airbag system will not work properly. See your dealer for service.

## Passenger Sensing System

Your vehicle has a passenger sensing system for the right front passenger's position. A passenger airbag status indicator in the rearview mirror will be visible when you turn your ignition key to START or RUN.

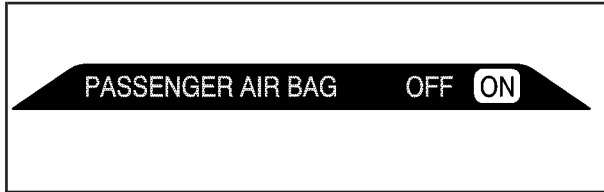

United States

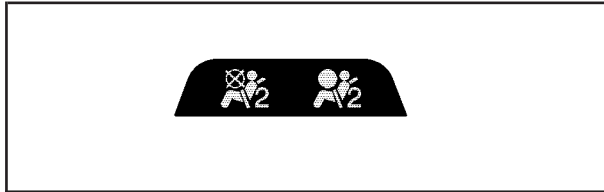

Canada

The words ON and OFF, or the symbol for on and off, will be visible during the system check. When the system check is complete, either the word ON or the word OFF, or the symbol for on or the symbol for off, will be visible. See *Passenger Airbag Status Indicator* on page 200.

The passenger sensing system will turn off the right front passenger's frontal airbag under certain conditions. The driver's airbags are not part of the passenger sensing system.

The passenger sensing system works with sensors that are part of the right front passenger's seat and safety belt. The sensors are designed to detect the presence of a properly-seated occupant and determine if the passenger's frontal airbag should be enabled (may inflate) or not.

Accident statistics show that children are safer if they are restrained in the rear rather than the front seat. We recommend that child restraints be secured in a rear seat, including an infant riding in a rear-facing infant seat, a child riding in a forward-facing child seat, and an older child riding in a booster seat.

If your vehicle has a rear seat that will accommodate a rear-facing child restraint, a label on your sun visor says, “Never put a rear-facing child seat in the front.” This is because the risk to the rear-facing child is so great, if the airbag deploys.



### **CAUTION:**

**A child in a rear-facing child restraint can be seriously injured or killed if the right front passenger’s airbag inflates. This is because the back of the rear-facing child restraint would be very close to the inflating airbag.**

**CAUTION: (Continued)**

### **CAUTION: (Continued)**

**Even though the passenger sensing system is designed to turn off the passenger’s frontal airbag if the system detects a rear-facing child restraint, no system is fail-safe, and no one can guarantee that an airbag will not deploy under some unusual circumstance, even though it is turned off. We recommend that rear-facing child restraints be secured in the rear seat, even if the airbag is off.**

**If you need to secure a forward-facing child restraint in the right front seat, always move the front passenger seat as far back as it will go. It is better to secure the child restraint in a rear seat.**

If your vehicle does not have a rear seat that will accommodate a rear-facing child restraint, never put a child in a rear-facing child restraint in the right front passenger seat unless the passenger airbag status indicator shows off and the airbag is off. Here is why:

 **CAUTION:**

**A child in a rear-facing child restraint can be seriously injured or killed if the right front passenger's airbag inflates. This is because the back of the rear-facing child restraint would be very close to the inflating airbag. Be sure the airbag is off before using a rear-facing child restraint in the right front seat position.**

**CAUTION: (Continued)**

**CAUTION: (Continued)**

**Even though the passenger sensing system is designed to turn off the passenger's frontal airbag if the system detects a rear-facing child restraint, no system is fail-safe, and no one can guarantee that an airbag will not deploy under some unusual circumstance, even though it is turned off. We recommend that rear-facing child restraints be transported in vehicles with a rear seat that will accommodate a rear-facing child restraint, whenever possible.**

**If you need to secure a forward-facing child restraint in the right front seat, always move the front passenger seat as far back as it will go. It is better to secure the child restraint in a rear seat.**

The passenger sensing system is designed to turn off the right front passenger's frontal airbag if:

- The right front passenger seat is unoccupied.
- The system determines that an infant is present in a rear-facing infant seat.
- The system determines that a small child is present in a forward-facing child restraint.
- The system determines that a small child is present in a booster seat.
- A right front passenger takes his/her weight off of the seat for a period of time.
- The right front passenger seat is occupied by a smaller person, such as a child who has outgrown child restraints.
- Or, if there is a critical problem with the airbag system or the passenger sensing system.

When the passenger sensing system has turned off the passenger's frontal airbag, the off indicator in the rearview mirror will light and stay lit to remind you that the airbag is off.

If a child restraint has been installed and the on indicator is lit, turn the vehicle off. Remove the child restraint from the vehicle and reinstall the child restraint following the child restraint manufacturer's directions and refer to *Securing a Child Restraint in the Right Front Seat Position* on page 66.

If, after reinstalling the child restraint and restarting the vehicle, the on indicator is still lit, check to make sure that the vehicle's seatback is not pressing the child restraint into the seat cushion. If this happens, slightly recline the vehicle's seatback and adjust the seat cushion if possible. Also make sure the child restraint is not trapped under the vehicle head restraint. If this happens, adjust the head restraint.

If the on indicator is still lit, secure the child in the child restraint in a rear seat position in the vehicle and check with your dealer.

The passenger sensing system is designed to enable (may inflate) the right front passenger's frontal airbag anytime the system senses that a person of adult size is sitting properly in the right front passenger's seat. When the passenger sensing system has allowed the airbag to be enabled, the on indicator will light and stay lit to remind you that the airbag is active.

For some children who have outgrown child restraints and for very small adults, the passenger sensing system may or may not turn off the right front passenger's frontal airbag, depending upon the person's seating posture and body build. Everyone in your vehicle who has outgrown child restraints should wear a safety belt properly — whether or not there is an airbag for that person.

If a person of adult-size is sitting in the right front passenger's seat, but the off indicator is lit, it could be because that person is not sitting properly in the seat. If this happens, turn the vehicle off and ask the person to place the seatback in the fully upright position, then sit upright in the seat, centered on the seat cushion, with the person's legs comfortably extended.

Restart the vehicle and have the person remain in this position for about two minutes. This will allow the system to detect that person and then enable the passenger's airbag.



 **CAUTION:**

**If the airbag readiness light in the instrument panel cluster ever comes on and stays on, it means that something may be wrong with the airbag system. If this ever happens, have the vehicle serviced promptly, because an adult-size person sitting in the right front passenger's seat may not have the protection of the frontal airbag. See *Airbag Readiness Light* on page 199 for more on this, including important safety information.**

Aftermarket equipment, such as seat covers, can affect how well the passenger sensing system operates. You may want to consider not using seat covers or other aftermarket equipment if your vehicle has the passenger sensing system. See *Adding Equipment to Your Airbag-Equipped Vehicle* on page 89 for more information about modifications that can affect how the system operates.

 **CAUTION:**

**Stowing of articles under the passenger's seat or between the passenger's seat cushion and seatback may interfere with the proper operation of the passenger sensing system.**

## Servicing Your Airbag-Equipped Vehicle

Airbags affect how your vehicle should be serviced. There are parts of the airbag system in several places around your vehicle. You do not want the system to inflate while someone is working on your vehicle. Your dealer and the service manual have information about servicing your vehicle and the airbag system. To purchase a service manual, see *Service Publications Ordering Information on page 555*.

### CAUTION:

**For up to 10 seconds after the ignition key is turned off and the battery is disconnected, an airbag can still inflate during improper service. You can be injured if you are close to an airbag when it inflates. Avoid yellow connectors. They are probably part of the airbag system. Be sure to follow proper service procedures, and make sure the person performing work for you is qualified to do so.**

The airbag system does not need regular maintenance.



## Adding Equipment to Your Airbag-Equipped Vehicle

**Q:** Is there anything I might add to the front or sides of the vehicle that could keep the airbags from working properly?

**A:** Yes. If you add things that change your vehicle's frame, bumper system, height, front end or side sheet metal, they may keep the airbag system from working properly. Also, the airbag system may not work properly if you relocate any of the airbag sensors. If you have any questions about this, you should contact Customer Assistance before you modify your vehicle. The phone numbers and addresses for Customer Assistance are in Step Two of the Customer Satisfaction Procedure in this manual. See *Customer Satisfaction Procedure on page 536*.

**Q:** Because I have a disability, I have to get my vehicle modified. How can I find out whether this will affect my airbag system?

**A:** Changing or moving any parts of the front seats, safety belts, the airbag sensing and diagnostic module, steering wheel, instrument panel, the inside review mirror, ceiling headliner, ceiling and pillar garnish trim, roof-mounted airbag modules, or airbag wiring can affect the operation of the airbag system. If you have questions, call Customer Assistance. The phone numbers and addresses for Customer Assistance are in Step Two of the Customer Satisfaction Procedure in this manual. See *Customer Satisfaction Procedure on page 536*.

# Restraint System Check

## Checking the Restraint Systems

Now and then, make sure the safety belt reminder light and all your belts, buckles, latch plates, retractors and anchorages are working properly. Look for any other loose or damaged safety belt system parts. If you see anything that might keep a safety belt system from doing its job, have it repaired. Keep safety belts clean and dry. See *Care of Safety Belts on page 493* for more information.

Torn or frayed safety belts may not protect you in a crash. They can rip apart under impact forces. If a belt is torn or frayed, get a new one right away.

Also look for any opened or broken airbag covers, and have them repaired or replaced. The airbag system does not need regular maintenance.

**Notice:** If you damage the covering for the driver's or the right front passenger's airbag, or the side impact airbag covering on the ceiling near the side windows, the airbag may not work properly. You may have to replace the airbag module in the steering wheel, both the airbag module and the instrument panel for the right front passenger's airbag, or side impact airbag module and ceiling covering for roof-mounted rollover airbags (if equipped). Do not open or break the airbag coverings.

## Replacing Restraint System Parts After a Crash

### CAUTION:

**A crash can damage the restraint systems in your vehicle. A damaged restraint system may not properly protect the person using it, resulting in serious injury or even death in a crash. To help make sure your restraint systems are working properly after a crash, have them inspected and any necessary replacements made as soon as possible.**

If you have had a crash, do you need new belts or LATCH system parts?

After a very minor collision, nothing may be necessary. But if the belts were stretched, as they would be if worn during a more severe crash, then you need new parts.

If the LATCH system was being used during a more severe crash, you may need new LATCH system parts.

If belts are cut or damaged, replace them. Collision damage also may mean you will need to have LATCH system, safety belt or seat parts repaired or replaced. New parts and repairs may be necessary even if the belt or LATCH system was not being used at the time of the collision.

If an airbag inflates, you will need to replace airbag system parts. See the part on the airbag system earlier in this section.

If the frontal airbags inflate you will also need to replace the driver and front passenger's safety belt retractor assembly. Be sure to do so. Then the new retractor assembly will be there to help protect you in a collision.

After a crash you may need to replace the driver and front passenger's safety belt retractor assemblies, even if the frontal airbags have not deployed. The driver and front passenger's safety belt retractor assemblies contain the safety belt pretensioners. Have your safety belt pretensioners checked if your vehicle has been in a collision, or if your airbag readiness light stays on after you start your vehicle or while you are driving. See *Airbag Readiness Light on page 199*.



## Section 2 Features and Controls

---

<b>Keys</b> .....	95	<b>Starting and Operating Your Vehicle</b> .....	112
Remote Keyless Entry (RKE) System .....	96	New Vehicle Break-In .....	112
Remote Keyless Entry (RKE) System Operation .....	98	Ignition Positions .....	113
<b>Doors and Locks</b> .....	100	Retained Accessory Power (RAP) .....	114
Door Locks .....	100	Starting the Engine .....	114
Power Door Locks .....	101	Adjustable Throttle and Brake Pedal .....	116
Delayed Locking .....	102	Engine Coolant Heater .....	116
Programmable Automatic Door Locks .....	102	Active Fuel Management™ .....	117
Rear Door Security Locks .....	105	Automatic Transmission Operation .....	118
Lockout Protection .....	105	Four-Wheel Drive .....	122
Liftgate/Liftglass .....	106	Parking Brake .....	126
<b>Windows</b> .....	107	Shifting Into Park (P) .....	127
Power Windows .....	108	Shifting Out of Park (P) .....	129
Sun Visors .....	109	Parking Over Things That Burn .....	129
<b>Theft-Deterrent Systems</b> .....	109	Engine Exhaust .....	130
Content Theft-Deterrent .....	110	Running the Engine While Parked .....	131
Passlock® .....	111		

## Section 2 Features and Controls

---

<b>Mirrors</b> .....	132	<b>Universal Home Remote System</b> .....	149
Manual Rearview Mirror .....	132	Universal Home Remote System (With Three Round LED) .....	149
Manual Rearview Mirror with OnStar® .....	132	Universal Home Remote System (With One Triangular LED) .....	149
Automatic Dimming Rearview Mirror with OnStar® and Compass .....	133	Universal Home Remote System Operation (With Three Round LED) .....	150
Automatic Dimming Rearview Mirror with OnStar®, Compass and Temperature Display .....	135	Universal Home Remote System Operation (With One Triangular LED) .....	156
Automatic Dimming Rearview Mirror with Compass .....	138	<b>Storage Areas</b> .....	160
Automatic Dimming Rearview Mirror with Compass and Temperature Display .....	140	Glove Box .....	160
Outside Manual Mirrors .....	143	Overhead Console .....	160
Outside Power Mirrors .....	143	Center Console Storage Area .....	160
Outside Curb View Assist Mirror .....	144	Luggage Carrier .....	161
Outside Convex Mirror .....	144	Rear Floor Storage Lid .....	162
Outside Heated Mirrors .....	145	Convenience Net .....	162
<b>OnStar® System</b> .....	145	Cargo Cover .....	163
		Cargo Tie Downs .....	164
		<b>Sunroof</b> .....	164

# Keys

## ⚠ CAUTION:

Leaving children in a vehicle with the ignition key is dangerous for many reasons. They could operate the power windows or other controls or even make the vehicle move. The children or others could be badly injured or even killed. Do not leave the keys in a vehicle with children.

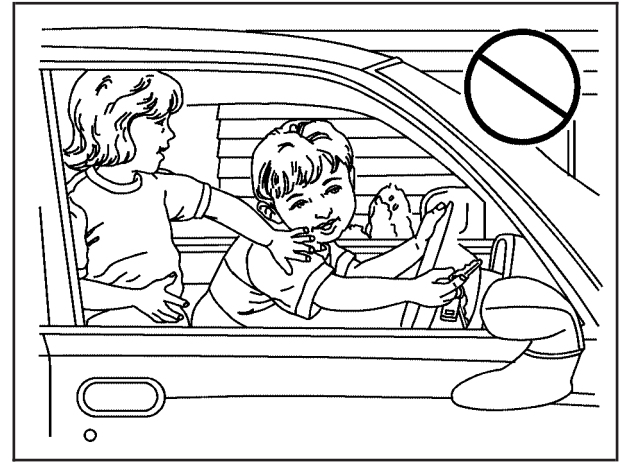

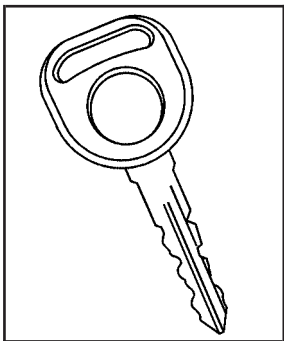

This vehicle has keys that can be used for the ignition and door lock that will fit with either side up.

When a new vehicle is delivered, the dealer provides the owner with a pair of identical keys and a key code number.

The key code number tells your dealer or a qualified locksmith how to make extra keys. Keep this number in a safe place. If you lose your keys, you will be able to have new ones made easily using this number. Your selling dealer should also have this number.

**Notice:** If you ever lock your keys in your vehicle, you may have to damage the vehicle to get in. Be sure you have spare keys.

If you ever do get locked out of your vehicle, call the GM Roadside Assistance Center. See *Roadside Assistance Program on page 542*.

## Remote Keyless Entry (RKE) System

If the vehicle has the Remote Keyless Entry (RKE) system, it operates on a radio frequency subject to Federal Communications Commission (FCC) Rules and with Industry Canada.

This device complies with Part 15 of the FCC Rules. Operation is subject to the following two conditions:

1. This device may not cause interference.
2. This device must accept any interference received, including interference that may cause undesired operation of the device.



This device complies with RSS-210 of Industry Canada. Operation is subject to the following two conditions:

1. This device may not cause interference.
2. This device must accept any interference received, including interference that may cause undesired operation of the device.

Changes or modifications to this system by other than an authorized service facility could void authorization to use this equipment.

At times you may notice a decrease in range. This is normal for any RKE system. If the transmitter does not work or if you have to stand closer to your vehicle for the transmitter to work, try this:

- Check the distance. You may be too far from your vehicle. You may need to stand closer during rainy or snowy weather.
- Check the location. Other vehicles or objects may be blocking the signal. Take a few steps to the left or right, hold the transmitter higher, and try again.
- Check to determine if battery replacement is necessary. See “Battery Replacement” under *Remote Keyless Entry (RKE) System Operation on page 98*.
- If you are still having trouble, see your dealer or a qualified technician for service.

## Remote Keyless Entry (RKE) System Operation

If your vehicle has this feature, you can lock and unlock your doors from about 3 feet (1 m) up to 30 feet (9 m) away using the RKE transmitter supplied with your vehicle.

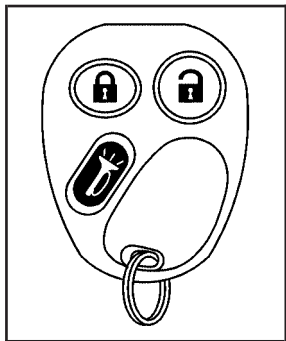

**U (Unlock):** Press unlock for the driver's door to unlock automatically, the parking lamps to flash and the interior lights to go on. Press the unlock button a second time within three seconds to unlock all the doors.

You can program different feedback settings through the Driver Information Center (DIC). For more information see *Driver Information Center (DIC)* on page 216.

**L (Lock):** Press lock to lock all the doors. Press lock again within three seconds and the horn will chirp.

**H (Panic):** Press the horn symbol to make the horn sound. The headlamps and taillamps will flash for up to 30 seconds. This can be turned off by pressing the horn button again, by waiting for 30 seconds, or by starting the vehicle.

### Matching Transmitter(s) to Your Vehicle

Each RKE transmitter is coded to prevent another transmitter from unlocking your vehicle. If a transmitter is lost or stolen, a replacement can be purchased through your dealer. Remember to bring any remaining transmitters with you when you go to your dealer. When the dealer matches the replacement transmitter to your vehicle, any remaining transmitters must also be matched. Once your dealer has coded the new transmitter, the lost transmitter will not unlock your vehicle. Each vehicle can have a maximum of four transmitters matched to it.

## Battery Replacement

Under normal use, the battery in your RKE transmitter should last about two years.

the battery is weak if the transmitter does not work at the normal range in any location. If you have to get close to your vehicle before the transmitter works, it is probably time to change the battery.

The Driver Information Center (DIC) will display a KEY FOB # BATTERY LOW message when the transmitter battery is low.

**Notice:** When replacing the battery, use care not to touch any of the circuitry. Static from your body transferred to these surfaces may damage the transmitter.

To replace the battery in the RKE transmitter do the following:

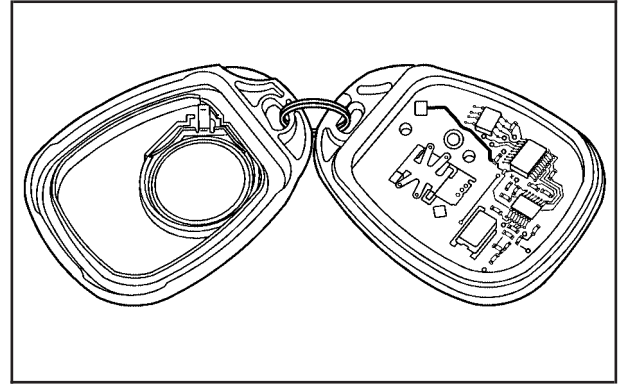

1. Insert a thin coin in the slot between the covers of the transmitter housing. Gently pry the transmitter apart.
2. Remove and replace the battery with a three-volt CR2032 or equivalent battery.
3. Align the covers and snap them together.
4. Check the operation of the transmitter.

# Doors and Locks

## Door Locks

### CAUTION:

Unlocked doors can be dangerous.

- Passengers, especially children, can easily open the doors and fall out of a moving vehicle. When a door is locked, the handle will not open it. You increase the chance of being thrown out of the vehicle in a crash if the doors are not locked. So, wear safety belts properly and lock the doors whenever you drive.

**CAUTION: (Continued)**

### CAUTION: (Continued)

- Young children who get into unlocked vehicles may be unable to get out. A child can be overcome by extreme heat and can suffer permanent injuries or even death from heat stroke. Always lock your vehicle whenever you leave it.
- Outsiders can easily enter through an unlocked door when you slow down or stop your vehicle. Locking your doors can help prevent this from happening.

There are several ways to lock and unlock your vehicle. You can use the remote keyless entry transmitter.

You can use your key to unlock your door from the outside.

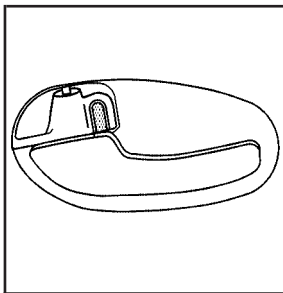

You can lock or unlock the door from the inside by sliding the manual lever forward or rearward.

When the door is unlocked, you can see a red area on the lever.

The manual lever on each door works only that door's lock.

## Power Door Locks

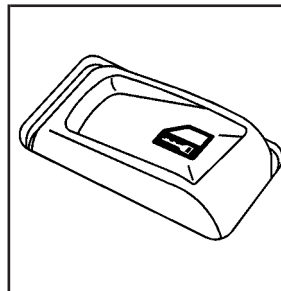

The power door lock switches are located on the driver's and front passenger's door armrests.

Press the lock symbol to lock all of the doors. To unlock the doors, press the other side of the switch.

## Delayed Locking

This feature delays the locking of the doors and the liftgate when using the power lock or the remote keyless entry system.

The first press of the power door lock switch or lock button on the remote keyless entry transmitter with the driver's door open will activate the delay locking. A chime will sound. All doors and the liftgate can be reopened for up to five seconds from the time the last door is closed.

Five seconds after the last door is closed, all the doors will lock. You can lock the doors immediately by using the power door lock switch or by pressing the lock button on the optional remote keyless entry transmitter a second time.

If the key is inserted in the ignition, this feature will not lock the doors. See *Lockout Protection on page 105*.

You can turn the delayed locking feature on or off. If the feature is turned off, the doors will lock immediately when a power door lock switch or remote keyless entry transmitter lock button is pressed.

## Programming Delayed Locking

To turn the delayed locking feature on or off, do the following:

1. Press and hold the power door lock switch on the driver's door in the lock position.
2. Press the remote keyless entry transmitter unlock button twice.

If the delayed locking feature was on, it will now be off. If the feature was off, it will now be on.

## Programmable Automatic Door Locks

Your vehicle is equipped with an automatic lock/unlock feature which enables you to program your vehicle's power door locks. You can program this feature through the Driver Information Center (DIC), or by the following method. See *DIC Vehicle Customization on page 226*.

## Programmable Locking Feature

Following are the two locking modes that can be programmed:

**Mode 1:** All doors lock when the transmission is shifted out of PARK (P).

**Mode 2:** All doors lock when the vehicle speed is greater than 8 mph (13 km/h).

The automatic door locks were pre-programmed at the factory to lock all the doors when the transmission is shifted into gear. The following instructions detail how to program your door locks differently than the factory setting. Choose one of the two programming options listed previously before entering the program mode.

To enter the program mode, do the following:

1. Begin with the ignition off. Then pull the turn signal/multifunction lever toward you and hold it there while you perform the next step.
2. Turn the key to RUN and LOCK twice. Then, with the key in LOCK, release the turn signal/multifunction lever. Once you do this, you will hear the lock switch lock and unlock, the horn will chirp twice, and a 30-second program timer will begin.

3. You are now ready to program the automatic door locks. Select one of the two programming options listed previously, and press the lock side of the power door lock switch to cycle through the lock options. You will have 30 seconds to begin programming. If you exceed the 30-second limit, the locks will automatically lock and unlock and the horn will chirp twice to indicate that you have left the program mode. If this occurs, repeat the procedure beginning with Step 1 to re-enter the programming mode.

You can exit the program mode any time by turning the ignition to RUN. The locks will automatically lock and unlock and the horn will chirp twice to indicate that you are leaving the program mode. If the lock/unlock switches are not pressed while in the programming mode, the current auto lock/unlock setting will not be modified.

See your dealer for more information.

## Programmable Unlocking Feature

The following is the list of available programming options:

**Mode 1:** Driver's door unlocks when the transmission is shifted into PARK (P).

**Mode 2:** All doors unlock when the transmission is shifted into PARK (P).

**Mode 3:** All doors unlock when the key is removed from the ignition.

**Mode 4:** No automatic door unlock.

The automatic door locks were pre-programmed at the factory to unlock all doors once the transmission is shifted to PARK (P). The following instructions detail how to program your door locks differently than the factory setting. Choose one of the four programming options listed previously before entering the program mode.

To enter the program mode you need to do the following:

1. Begin with the ignition off. Then pull the turn signal/multifunction lever toward you and hold it there while you perform the next step.

2. Turn the key to RUN and LOCK twice. Then, with the key in LOCK, release the turn signal/multifunction lever. Once you do this, you will hear the lock switch lock and unlock, the horn will chirp twice, and a 30-second program timer will begin.
3. You are now ready to program the automatic door locks. Select one of the four programming options listed above, and press the unlock side of the power door lock switch to cycle through the unlocking options. You will have 30 seconds to begin programming. If you exceed the 30-second limit, the locks will automatically lock and unlock and the horn will chirp twice to indicate that you have left the program mode. If this occurs, repeat the procedure beginning with Step 1 to re-enter the programming mode.

You can exit the program mode any time by turning the ignition to RUN. The locks will automatically lock and unlock and the horn will chirp twice to indicate that you are leaving the program mode. If the lock/unlock switches are not pressed while in the programming mode, the current auto lock/unlock setting will not be modified.

See your dealer for more information.



## Rear Door Security Locks

Your vehicle may have this feature. You can lock the rear doors so they cannot be opened from the inside by passengers. To use one of these locks do the following:

1. Open one of the rear doors. You will find a security lock lever located on the inside edge of each rear door.

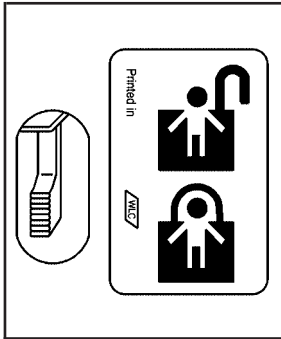

2. Move the lever down to engage the security lock. Move the lever up to disengage the security lock.

3. Close the door.

The rear doors of your vehicle cannot be opened from the inside while this feature is in use. If you want to open the rear door while the security lock is on, unlock the door and open the door from the outside.

## Lockout Protection

This feature stops the power door locks from locking when the key is in the ignition and a door is open to protect you from locking your key in the vehicle.

If the power lock switch is pressed when a door is open and the key is in the ignition, all the doors will lock and then the driver's door will unlock.

## Liftgate/Liftglass

### CAUTION:

It can be dangerous to drive with the liftgate or liftglass open because carbon monoxide (CO) gas can come into your vehicle. You cannot see or smell CO. It can cause unconsciousness and even death. If you must drive with the liftgate open or if electrical wiring or other cable connections must pass through the seal between the body and the liftgate or liftglass:

- Make sure all other windows are shut.
- Turn the fan on your climate control system to its highest speed and select the control setting that will force outside air into your vehicle. See “Climate Control System” in the Index.
- If you have air outlets on or under the instrument panel, open them all the way. See *Engine Exhaust on page 130*.

## Liftgate Release

To unlock the liftgate, use the power door lock switch or the remote keyless entry transmitter. See *Remote Keyless Entry (RKE) System Operation on page 98*. The liftglass will also unlock when the liftgate is unlocked.

Press the button on the liftglass to open it. To open the entire liftgate, lift the handle located in the center of the liftgate. When the liftgate is opened, the liftglass will lock after a short delay.

## Emergency Release for Opening Liftgate

1. Remove the trim plug, located on the inside of the liftgate in the center, to expose the access hole in the trim panel.
2. Use a tool to reach through the access hole in the trim panel.
3. Pry the left release lever up to the unlock position. Pry the right release lever up to unlatch the liftgate.
4. Reinstall the trim plug.

# Windows

## CAUTION:

Leaving children, helpless adults, or pets in a vehicle with the windows closed is dangerous. They can be overcome by the extreme heat and suffer permanent injuries or even death from heat stroke. Never leave a child, a helpless adult, or a pet alone in a vehicle, especially with the windows closed in warm or hot weather.

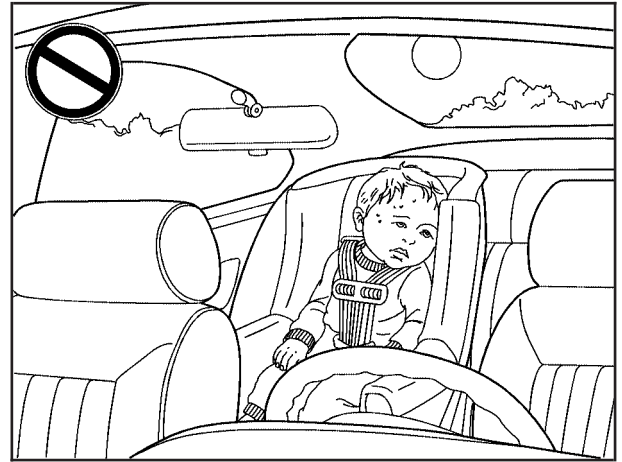

## Power Windows

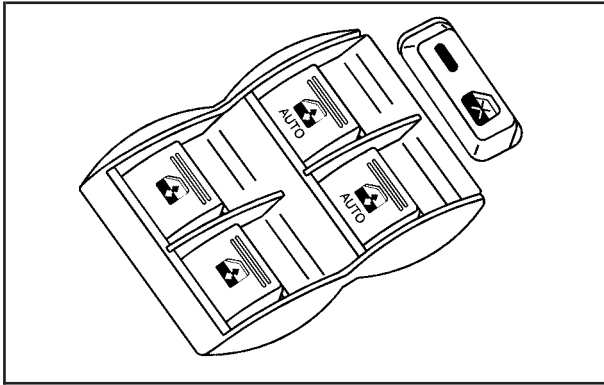

The controls for the power windows are located on the armrest on each of the side doors. With power windows, the switches operate the windows when the ignition is in RUN, ACCESSORY or when Retained Accessory Power (RAP) is active. See *Retained Accessory Power (RAP)* on page 114. The driver's door also has a switch for each of the passenger's windows.

Press down the top of the switch to lower the window and pull up on the switch to raise the window. If you hold the switch down for three to seven seconds after the window has been completely lowered or raised, the window will not operate for about 15 seconds.

### Express-Down Window

**AUTO (Express-down):** The driver's and front passenger's window switches have an express-down feature that allows you to lower the window without holding the switch down. Press down briefly on the driver's or front passenger's window switch labeled AUTO to activate the express-down feature. Lightly tap the switch to open the window slightly. The express-down feature can be interrupted at any time by pressing the top of the switch.

## Window Lockout

 **(Lockout):** Your vehicle has a lockout feature to prevent passengers from operating the power windows. The lockout switch is located in front of the window switches on the driver's door. A light in the lockout switch will come on to show that the switch has been activated. Press the lockout switch again to return to normal operation.

## Sun Visors

### Sun Visors with Slide Rod

Your vehicle may have this feature. Pull the sun visor down to block glare. Detach the sun visor from the center mount and slide it along the rod from side-to-side to cover the driver or passenger side of the front window. Swing the sun visor to the side to cover the side window. It can also be moved along the rod from side-to-side in this position.

### Sun Visors with Fixed Rod and Pull-out Extension

Your vehicle may have this feature. Pull the sun visor down to block glare. Pull the sun visor extender out for additional coverage. Detach the sun visor from the center mount and swing it to the side to cover the side window.

### Visor Vanity Mirror

Pull the sun visor down to expose the vanity mirror. You may have to lift a cover to expose the mirror.

### Lighted Visor Vanity Mirror

Your vehicle may have this feature. Pull the sun visor down and lift the mirror cover to turn on the lamps. The lamps will turn off when the cover is closed.

## Theft-Deterrent Systems

Vehicle theft is big business, especially in some cities. Although your vehicle has a number of theft-deterrent features, we know that nothing we put on it can make it impossible to steal.

## Content Theft-Deterrent

Your vehicle may have a content theft-deterrent alarm system.

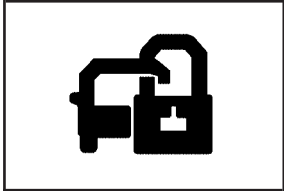

The security light is located on the instrument panel cluster.

To operate the system, do the following:

1. Open the door.
2. Lock the door with the power door lock switch or the Remote Keyless Entry (RKE) transmitter. The security light should flash.
3. Close all doors. The security light should turn off after about 30 seconds. The alarm is not armed until the security light turns off.

If a locked door is opened without the key or the RKE transmitter, the alarm will go off. The headlamps and parking lamps will flash for two minutes, and the horn will sound for 30 seconds, then will turn off to save the battery power.

Remember, the theft-deterrent system will not activate if you lock the doors with a key or use the manual door lock. It activates only if you use a power door lock switch with the door open, or with the RKE transmitter. You should also remember that you can start your vehicle with the correct ignition key if the alarm has been set off.

To avoid setting off the alarm by accident, do the following:

- Always lock the vehicle using the door key *after* the doors are closed.
- Always unlock a door with a key, or use the RKE transmitter. Unlocking a door any other way will set off the alarm.

If you set off the alarm by accident, unlock any door with the key. You can also turn off the alarm by pressing unlock on the RKE transmitter. The alarm will not stop if you try to unlock a door any other way.

## Testing the Alarm

To test the alarm, do the following:

1. From inside the vehicle, lower the driver's window and open the driver's door.
2. Activate the system by locking the doors with the power door lock switch while the door is open, or with the RKE transmitter.
3. Get out of the vehicle, close the door and wait for the security light to go out.
4. Then reach in through the window, unlock the door with the manual door lock and open the door. This should set off the alarm.

When the alarm is set the power door unlock switch will not work.

If the alarm does not sound when it should but the headlamps flash, check to see if the horn works. The horn fuse may be blown. To replace the fuse, see *Fuses and Circuit Breakers on page 501*.

If the alarm does not sound or the headlamps do not flash, the vehicle should be serviced by your dealer.

## Passlock<sup>®</sup>

Your vehicle has the Passlock<sup>®</sup> theft-deterrent system.

Passlock<sup>®</sup> is a passive theft-deterrent system that enables fuel if the ignition lock cylinder is turned with a valid key. If a correct key is not used or the ignition lock cylinder has been tampered with, the fuel system is disabled and the vehicle will not start.

During normal operation, the security light will turn off about five seconds after the key is turned to RUN.

If the engine stalls and the security light flashes, wait about 10 minutes until the light stops flashing before trying to restart the engine. Remember to release the key from START as soon as the engine starts.

If the engine does not start after three tries, the vehicle needs service.

If the engine is running and the security light comes on, you will be able to restart the engine if you turn the engine off. However, your Passlock® system is not working properly and must be serviced by your dealer. Your vehicle is not protected by Passlock® at this time. You may also want to check the fuse. See *Fuses and Circuit Breakers on page 501*. See your dealer for service.

In an emergency, call the GM Roadside Assistance Center. See *Roadside Assistance Program on page 542*.

## Starting and Operating Your Vehicle

### New Vehicle Break-In

**Notice:** Your vehicle does not need an elaborate break-in. But it will perform better in the long run if you follow these guidelines:

- Keep your speed at 55 mph (88 km/h) or less for the first 500 miles (805 km).
- Do not drive at any one constant speed, fast or slow, for the first 500 miles (805 km). Do not make full-throttle starts. Avoid downshifting to brake, or slow, the vehicle.

- **Avoid making hard stops for the first 200 miles (322 km) or so. During this time your new brake linings are not yet broken in. Hard stops with new linings can mean premature wear and earlier replacement. Follow this breaking-in guideline every time you get new brake linings.**
- **Do not tow a trailer during break-in. See *Towing a Trailer on page 363* for the trailer towing capabilities of your vehicle and more information.**

Following break-in, engine speed and load can be gradually increased.



## Ignition Positions

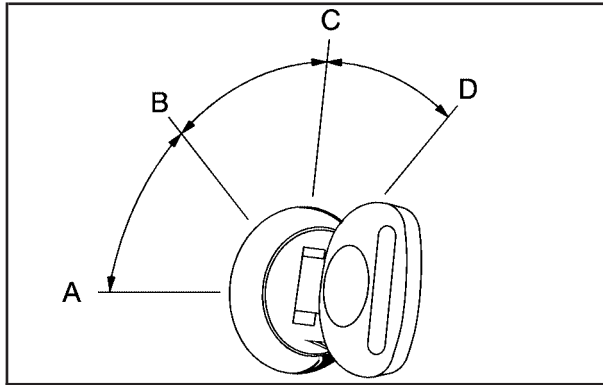

Use the key to turn the ignition switch to four different positions.

**A (LOCK):** This position locks the ignition and transmission. It is a theft-deterrent feature. You will only be able to remove the key when the ignition is turned to LOCK.

**Notice:** If your key seems stuck in LOCK and you cannot turn it, be sure you are using the correct key; if so, is it all the way in? Turn the key only with your hand. Using a tool to force it could break the key or the ignition switch. If none of these works, then your vehicle needs service.

**B (ACCESSORY):** This position lets you use things like the radio and the windshield wipers when the engine is off.

Lengthy operation of features such as the radio in the accessory ignition position may drain the battery and prevent your vehicle from starting. Do not operate your vehicle in the accessory ignition position for a long period of time.

**C (RUN):** This is the position for driving.

The battery could be drained if you leave the key in the ACCESSORY or RUN position with the engine off. You may not be able to start your vehicle if the battery is allowed to drain for an extended period of time.

**D (START):** This position starts the engine.

## Key In the Ignition

Never leave your vehicle with the keys inside, as it is an easy target for joy riders or thieves. If you leave the key in the ignition and park your vehicle, a chime will sound, when you open the driver's door. Always remember to remove your key from the ignition and take it with you. This will lock your ignition and transmission. Also, always remember to lock the doors.

The battery could be drained if you leave the key in the ignition while your vehicle is parked. You may not be able to start your vehicle after it has been parked for an extended period of time.

## Retained Accessory Power (RAP)

Your vehicle has a Retained Accessory Power (RAP) feature which lets certain features of your vehicle to continue to work up to 20 minutes after the ignition key is turned to LOCK.

The radio, power windows, the overhead console and the sunroof, if the vehicle has one, work when the ignition key is in RUN or ACCESSORY. Once the key is turned from RUN to LOCK, these features continue to work for up to 20 minutes, or until a door is opened.

## Starting the Engine

Place the transmission in the proper gear.

Move your shift lever to PARK (P) or NEUTRAL (N). Your engine will not start in any other position -- this is a safety feature. To restart when you are already moving, use NEUTRAL (N) only.

**Notice:** Do not try to shift to PARK (P) if your vehicle is moving. If you do, you could damage the transmission. Shift to PARK (P) only when your vehicle is stopped.

## Starting Procedure

1. With your foot off the accelerator pedal, turn the ignition key to START. When the engine starts, let go of the key. The idle speed will go as your engine gets warm. Do not race the engine immediately after starting it. Operate the engine and transmission gently to let the oil to warm up and lubricate all moving parts.

Your vehicle has a Computer-Controlled Cranking System. This feature assists in starting the engine and protects components. If the ignition key is turned to the START position, and then released when the engine begins cranking, the engine continues cranking for a few seconds or until the vehicle starts. If the engine does not start and the key is held in START for many seconds, cranking stops after 15 seconds to prevent cranking motor damage. To prevent gear damage, this system also prevents cranking if the engine is already running. Engine cranking can be stopped by turning the ignition switch to the ACCESSORY or LOCK position.

**Notice:** Cranking the engine for long periods of time, by returning the key to the START position immediately after cranking has ended, can overheat and damage the cranking motor, and drain the battery. Wait at least 15 seconds between each try, to allow the cranking motor to cool down.

2. If the engine does not start after 5-10 seconds, especially in very cold weather (below 0°F or -18°C), it could be flooded with too much gasoline. Try pushing the accelerator pedal all the way to the floor and holding it there as you hold the key in START for up to a maximum of 15 seconds. Wait at least 15 seconds between each try, to allow the cranking motor to cool down. When the engine starts, let go of the key and accelerator. If the vehicle starts briefly but then stops again, do the same thing. This clears the extra gasoline from the engine. Do not race the engine immediately after starting it. Operate the engine and transmission gently until the oil warms up and lubricates all moving parts.

**Notice:** Your engine is designed to work with the electronics in your vehicle. If you add electrical parts or accessories, you could change the way the engine operates. Before adding electrical equipment, check with your dealer. If you do not, your engine might not perform properly. Any resulting damage would not be covered by your vehicle's warranty.

## Adjustable Throttle and Brake Pedal

If your vehicle has this feature, you can change the position of the throttle and brake pedals. This feature is designed for shorter drivers, since the pedals cannot move farther away from the standard position, but can move closer for better pedal reach. If your vehicle has this feature, it can be programmed to work with the memory function. See *Memory Seat, Mirrors, and Pedals* on page 11.

The vehicle must be in PARK (P) for this feature to operate.

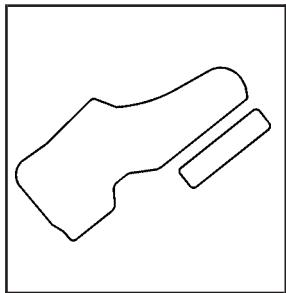

The switch used to adjust the pedals is located on the steering column.

Press the switch forward or backward to move the pedals closer or farther away from you.

## Engine Coolant Heater

Your vehicle may have an engine coolant heater.

In very cold weather, 0°F (-18°C) or colder, the engine coolant heater can help. You will get easier starting and better fuel economy during engine warm-up.

Usually, the coolant heater should be plugged in a minimum of four hours prior to starting your vehicle. At temperatures above 32°F (0°C), use of the coolant heater is not required. Your vehicle may also have an internal thermostat in the plug end of the cord. This will prevent operation of the engine coolant heater when the temperature is at or above 0°F (-18°C) as noted on the cord.

### To Use the Engine Coolant Heater

1. Turn off the engine.
2. Open the hood and unwrap the electrical cord. The cord is located on the driver's side of the engine compartment next to the battery box facing the engine.
3. Plug it into a normal, grounded 110-Volt AC outlet.

 **CAUTION:**

**Plugging the cord into an ungrounded outlet could cause an electrical shock. Also, the wrong kind of extension cord could overheat and cause a fire. You could be seriously injured. Plug the cord into a properly grounded three-prong 110-volt AC outlet. If the cord will not reach, use a heavy-duty three-prong extension cord rated for at least 15 amps.**

4. Before starting the engine, be sure to unplug and store the cord as it was before to keep it away from moving engine parts. If you do not, it could be damaged.

How long should you keep the coolant heater plugged in? The answer depends on the outside temperature, the kind of oil you have, and some other things. Instead of trying to list everything here, we ask that you contact your dealer in the area where you will be parking your vehicle. The dealer can give you the best advice for that particular area.

## **Active Fuel Management™**

Your vehicle's V8 engine may have Active Fuel Management™. This system allows the engine to operate on either all or half of its cylinders, depending on your driving conditions.

When less power is required, such as cruising at a constant vehicle speed, the system will operate in the half cylinder mode, allowing your vehicle to achieve better fuel economy. When greater power demands are required, such as accelerating from a stop, passing, or merging onto a freeway, the system will maintain full-cylinder operation.

## Automatic Transmission Operation

**P R N D 3 2 1**

There are several different positions for your gear shift lever.

**PARK (P):** This position locks the rear wheels. It is the best position to use when you start the engine because your vehicle cannot move easily.

### CAUTION:

It is dangerous to get out of your vehicle if the shift lever is not fully in PARK (P) with the parking brake firmly set. Your vehicle can roll.

Do not leave your vehicle when the engine is running unless you have to. If you have left the engine running, the vehicle can move suddenly. You or others could be injured. To be sure your vehicle will not move, even when you are on fairly level ground, always set your parking brake and move the shift lever to PARK (P). See *Shifting Into Park (P)* on page 127. If you are pulling a trailer, see *Towing a Trailer* on page 363.

 **CAUTION:**

**If you have four-wheel drive, your vehicle will be free to roll — even if your shift lever is in PARK (P) — if your transfer case is in NEUTRAL. So, be sure the transfer case is in a drive gear — not in NEUTRAL. See *Four-Wheel Drive on page 122*. See *Shifting Into Park (P) on page 127*.**

Make sure the shift lever is fully in PARK (P) before starting the engine. Your vehicle has an automatic transmission shift lock control system. You have to fully apply the regular brakes first and then press the shift lever button before you can shift from PARK (P) when the ignition key is

in RUN. If you cannot shift out of PARK (P), ease pressure on the shift lever and push the shift lever all the way into PARK (P) as you maintain brake application. Then press the shift lever button and move the shift lever into another gear. See *Shifting Out of Park (P) on page 129*.

**REVERSE (R):** Use this gear to back up.

***Notice:*** Shifting to REVERSE (R) while your vehicle is moving forward could damage the transmission. The repairs would not be covered by your warranty. Shift to REVERSE (R) only after your vehicle is stopped.

To rock your vehicle back and forth to get out of snow, ice, or sand without damaging your transmission, see *If Your Vehicle is Stuck in Sand, Mud, Ice, or Snow on page 348*.

**NEUTRAL (N):** In this position, the engine does not connect with the wheels. To restart when you are already moving, use NEUTRAL (N) only.

 **CAUTION:**

**Shifting into a drive gear while your engine is running at high speed is dangerous. Unless your foot is firmly on the brake pedal, your vehicle could move very rapidly. You could lose control and hit people or objects. Do not shift into a drive gear while your engine is running at high speed.**

**Notice:** Shifting out of PARK (P) or NEUTRAL (N) with the engine running at high speed may damage the transmission. The repairs would not be covered by your warranty. Be sure the engine is not running at high speed when shifting your vehicle.

**DRIVE (D):** This position is for normal driving. It provides the best fuel economy for your vehicle. If you need more power for passing, and you are:

- Going less than about 35 mph (55 km/h), push the accelerator pedal about halfway down.
- Going about 35 mph (55 km/h) or more, push the accelerator all the way down.  
You will shift down to the next gear and have more power.

Downshifting the transmission in slippery road conditions could result in skidding, see “Skidding” under *Loss of Control on page 316*.

DRIVE (D) can be used when towing a trailer, carrying a heavy load, driving on steep hills, or for off-road driving. You may want to shift the transmission to THIRD (3) or, if necessary, a lower gear selection if the transmission shifts too often.



**THIRD (3):** This position is also used for normal driving. It reduces vehicle speed more than DRIVE (D) without using your brakes. You might choose THIRD (3) instead of DRIVE (D) when driving on hilly, winding roads, when towing a trailer, so there is less shifting between gears and when going down a steep hill.

To shift to the THIRD (3) position, you must first press the large button on the shift handle. While the button is pressed, move the shifter in the THIRD (3) position.

**SECOND (2):** This position reduces vehicle speed even more than THIRD (3) without using your brakes. You can use SECOND (2) on hills. It can help control your speed as you go down steep mountain roads, but then you would also want to use your brakes off and on.

To shift to the SECOND (2) position, you must first press the large button on the shift handle. While the button is pressed, move the shifter in the SECOND (2) position.

You can also use SECOND (2) for starting the vehicle from a stop on slippery road surfaces.

**FIRST (1):** This position reduces vehicle speed even more than SECOND (2) without using your brakes. You can use it on very steep hills, or in deep snow or mud. If the shift lever is put in FIRST (1) while the vehicle is moving forward, the transmission will not shift into first gear until the vehicle is going slowly enough.

To shift to the FIRST (1) position, you must first press the large button on the shift handle. While the button is pressed, move the shifter in the FIRST (1) position.

**Notice:** Spinning the tires or holding the vehicle in one place on a hill using only the accelerator pedal may damage the transmission. The repair will not be covered by your warranty. If you are stuck, do not spin the tires. When stopping on a hill, use the brakes to hold the vehicle in place.

## Four-Wheel Drive

If your vehicle has four-wheel drive, the engine's driving power can be sent to all four wheels for extra traction. To get the most satisfaction out of four-wheel drive, you must be familiar with its operation. Read the part that follows before using four-wheel drive. You should use Two-Wheel High for most normal driving conditions.

**Notice:** Driving on clean, dry pavement in Four-Wheel-Drive High or Four-Wheel-Drive Low for an extended period of time may cause premature wear on your vehicle's powertrain. Do not drive on clean, dry pavement in Four-Wheel-Drive High or Four-Wheel-Drive Low for extended periods of time.

### Automatic Transfer Case

If your vehicle has four-wheel drive, the transfer case knob is located to the right of the steering wheel on the instrument panel.

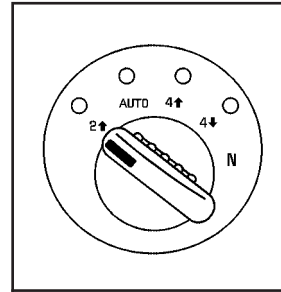

Use this knob to shift into and out of four-wheel drive

**2 ↑ (Two-Wheel High):** This setting is for driving in most street and highway situations. Your front axle is not engaged in two-wheel drive. It also provides the best fuel economy.

**AUTO (Automatic Four-Wheel Drive):** This setting is ideal for use when road conditions are variable. When driving your vehicle in automatic four-wheel drive, the front axle is engaged, but the vehicle's power is sent to the rear wheels. When the vehicle senses a loss of traction, the system will automatically engage four-wheel drive. Driving in this mode results in slightly lower fuel economy than Two-Wheel High.

**4 ↑ (Four-Wheel High):** This setting should be used when you need extra traction, such as on snowy or icy roads or in most off-road situations. This setting also engages your front axle to help drive your vehicle.

**4 ↓ (Four-Wheel Low):** This setting also engages your front axle and delivers extra torque. It sends maximum power to all four wheels. You might choose this setting if you are driving off-road in deep sand, deep mud, and climbing or descending steep hills.

 **CAUTION:**

**Shifting the transfer case to NEUTRAL can cause your vehicle to roll even if the transmission is in PARK (P). You or someone else could be seriously injured. Be sure to set the parking brake before placing the transfer case in NEUTRAL. See *Parking Brake* on page 126.**

**NEUTRAL:** Shift the vehicle's transfer case to NEUTRAL only when towing your vehicle. See *Recreational Vehicle Towing* on page 356 for more information.

An indicator light in the knob will show you which position the transfer case is in. The indicator lights will come on briefly when you turn on the ignition and one will stay on. If the lights do not come on, you should take your vehicle to your dealer for service. An indicator light will flash while shifting the transfer case. It will stay on when the shift is complete. If for some reason the transfer case cannot make a requested shift, it will return to the last chosen setting.

If the service Four-Wheel Drive Warning Light on the instrument panel cluster stays on, you should take your vehicle to your dealer for service. See *Service Four-Wheel Drive Warning Light* on page 214 for further information.

## **Shifting Into Four-Wheel High or Automatic Four-Wheel Drive**

Turn the knob to Four-Wheel High or Automatic Four-Wheel Drive. This can be done at any speed unless you are shifting out of Four-Wheel Low. The indicator light will flash while shifting. It will remain on when the shift is complete.

## **Shifting Into Two-Wheel High**

Turn the knob to Two-Wheel High. This can be done at any speed unless you are shifting out of Four-Wheel Low.

## **Shifting Into Four-Wheel Low**

To shift to Four-Wheel Low, the vehicle's engine must be running and the vehicle must be stopped or moving less than 2 mph (3.2 km/h) with the transmission in NEUTRAL (N). The preferred method for shifting into Four-Wheel Low is to have your vehicle moving 1 or 2 mph (1.6 to 3.2 km/h). Turn the knob to Four-Wheel Low. You must wait for the Four-Wheel Low indicator light to stop flashing and stay on before shifting the transmission into gear.

If you turn the knob to Four-Wheel Low when your vehicle is in gear and/or moving, the Four-Wheel Low indicator light will flash for 30 seconds and not complete the shift unless your vehicle is moving less than 2 mph (3.2 km/h) and the transmission is in NEUTRAL (N). After 30 seconds, the transfer case will return to the setting last chosen.

## **Shifting Out of Four-Wheel Low**

To shift from Four-Wheel Low to Four-Wheel High, Auto Four-Wheel Drive, or Two-Wheel High, your vehicle must be stopped or moving less than 2 mph (3.2 km/h) with the transmission in NEUTRAL (N) and the engine running. The preferred method for shifting out of Four-Wheel Low is to have your vehicle moving 1 or 2 mph (1.6 to 3.2 km/h). Turn the knob to Four-Wheel High, Auto Four-Wheel Drive, or Two-Wheel High. You must wait for the Four-Wheel High, Auto Four-Wheel Drive, or Two-Wheel High indicator light to stop flashing and stay off before shifting your transmission into gear.

If the knob is turned to Four Wheel-High, Auto Four-Wheel Drive, or Two-Wheel High when your vehicle is in gear and/or moving, the Four-Wheel High, Auto Four-Wheel Drive, or Two-Wheel High indicator light will flash for 30 seconds. It will not complete the shift unless your vehicle is moving less than 2 mph (3.2 km/h) with the transmission in NEUTRAL (N).

### Shifting into NEUTRAL

Before shifting the transfer case to NEUTRAL, first make sure the vehicle is parked so that it will not roll.

1. Set the parking brake.
2. Start the vehicle.
3. Put the transmission in NEUTRAL (N).
4. Shift the transfer case to Two-Wheel High.
5. Turn the transfer case knob all of the way past Four-Wheel Low and hold it there for a minimum of 10 seconds. The neutral indicator light will come on.
6. With the engine running, shift the transmission to REVERSE (R) for one second, then shift the transmission to DRIVE (D) for one second, to ensure that the transfer case is in NEUTRAL.

7. Turn the engine off, by turning the key to ACCESSORY.
8. Place the transmission shift lever in PARK (P).
9. Turn the ignition to LOCK.

### Shifting Out of NEUTRAL

To shift the transfer case out of NEUTRAL, do the following:

1. Set the parking brake and apply the regular brake pedal.
2. Turn the ignition to RUN with the engine off.
3. Put the transmission in NEUTRAL (N).
4. Turn the transfer case knob to the desired position (Two-Wheel High, Four-Wheel High, or Auto Four-Wheel Drive).
5. After the transfer case has shifted out of NEUTRAL, the indicator light will go out.
6. Release the parking brake.
7. Start the engine and shift the transmission to the desired position.

## Parking Brake

To set the parking brake, hold the regular brake pedal down with your foot and pull up on the parking brake lever located between the seats. If the ignition is on, the brake system warning light on the instrument panel cluster will come on. See *Brake System Warning Light* on page 204.

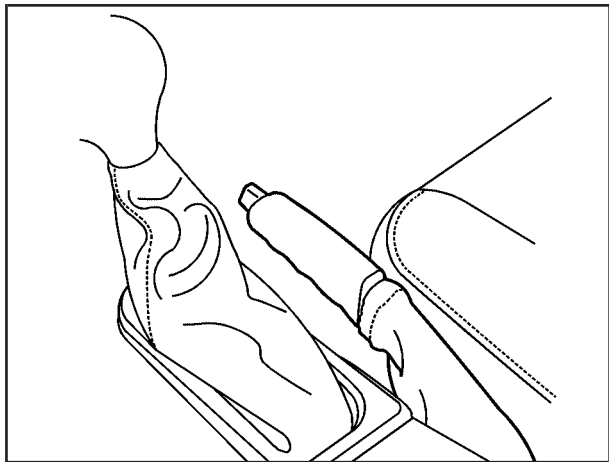

To release the parking brake, hold the regular brake pedal down. Pull the parking brake lever up until you can press in the button at the end of the lever. Hold the button in as you move the parking brake lever all the way down.

**Notice:** Driving with the parking brake on can overheat the brake system and cause premature wear or damage to brake system parts. Verify that the parking brake is fully released and the brake warning light is off before driving.

If you are towing a trailer and you must park on a hill, see *Towing a Trailer* on page 363.

## Shifting Into Park (P)

### CAUTION:

**It can be dangerous to get out of your vehicle if the shift lever is not fully in PARK (P) with the parking brake firmly set. Your vehicle can roll. If you have left the engine running, the vehicle can move suddenly. You or others could be injured. To be sure your vehicle will not move, even when you are on fairly level ground, use the steps that follow. With four-wheel drive, your vehicle will be free to roll — even if your shift lever is in PARK (P) — if your transfer case is in NEUTRAL. So, be sure the transfer case is in a drive gear — not in NEUTRAL. See *Four-Wheel Drive on page 122*. Always put the shift lever fully in PARK (P) with the parking brake firmly set. If you are pulling a trailer, see *Towing a Trailer on page 363*.**

To shift into PARK (P), do the following:

1. Hold the brake pedal down with your foot and set the parking brake.
2. Move the shift lever into PARK (P) by pressing the button on the side of the shift lever and pushing the lever all the way toward the front of the vehicle.
3. Turn the ignition key to LOCK.
4. Remove the key and take it with you. You know your vehicle is in PARK (P) if the key can be removed from the ignition.

## Leaving Your Vehicle With the Engine Running

### CAUTION:

**It can be dangerous to leave your vehicle with the engine running. Your vehicle could move suddenly if the shift lever is not fully in PARK (P) with the parking brake firmly set.**

**If you have four-wheel drive, your vehicle will be free to roll – even if your lever is in PARK (P) – if your transfer case is in NEUTRAL. So be sure the transfer case is in a drive gear – not NEUTRAL. See *Four-Wheel Drive on page 122.***

**And, if you leave the vehicle with the engine running, it could overheat and even catch fire. You or others could be injured. Do not leave your vehicle with the engine running unless you have to.**

If you have to leave your vehicle with the engine running, be sure your vehicle is in PARK (P) and your parking brake is firmly set before you leave it. After you have moved the shift lever into PARK (P), hold the regular brake pedal down. Then, see if you can move the shift lever away from PARK (P) without first pressing the button on the console shift lever. If you can, it means that the shift lever was not fully locked into PARK (P).

### **Torque Lock**

If you are parking on a hill and you do not shift your transmission into PARK (P) properly, the weight of the vehicle may put too much force on the parking pawl in the transmission. You may find it difficult to pull the shift lever out of PARK (P). This is called “torque lock.” To prevent torque lock, set the parking brake and then shift into PARK (P) properly before you leave the driver’s seat. To find out how, see *Shifting Into Park (P) on page 127.*



When you are ready to drive, move the shift lever out of PARK (P) before you release the parking brake.

If torque lock does occur, you may need to have another vehicle push yours a little uphill to take some of the pressure from the parking pawl in the transmission, so you can pull the shift lever out of PARK (P).

## Shifting Out of Park (P)

Your vehicle has an automatic transmission shift lock control system. You have to fully apply the regular brakes first and then press the shift lever button before you can shift from PARK (P) when the ignition is in RUN. See *Automatic Transmission Operation* on page 118.

## Parking Over Things That Burn

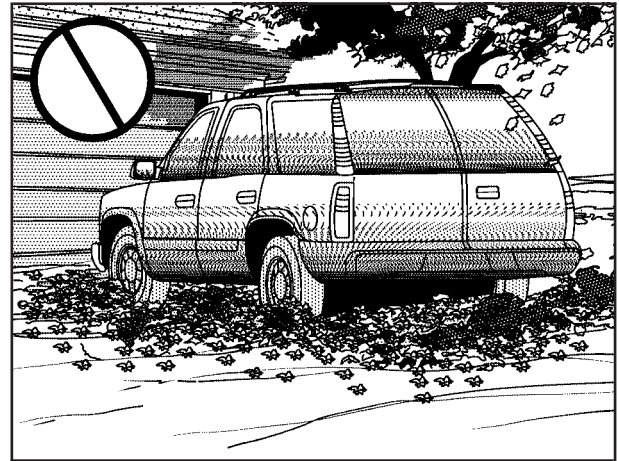

### CAUTION:

Things that can burn could touch hot exhaust parts under your vehicle and ignite. Do not park over papers, leaves, dry grass, or other things that can burn.

## Engine Exhaust

### CAUTION:

Engine exhaust can kill. It contains the gas carbon monoxide (CO), which you cannot see or smell. It can cause unconsciousness and death.

You might have exhaust coming in if:

- Your exhaust system sounds strange or different.
- Your vehicle gets rusty underneath.
- Your vehicle was damaged in a collision.
- Your vehicle was damaged when driving over high points on the road or over road debris.

**CAUTION: (Continued)**

### **CAUTION: (Continued)**

- Repairs were not done correctly.
- Your vehicle or exhaust system has been modified improperly.

If you ever suspect exhaust is coming into your vehicle:

- Drive it only with all the windows down to blow out any CO; and
- Have your vehicle fixed immediately.

## Running the Engine While Parked

It is better not to park with the engine running. But if you ever have to, here are some things to know.

### CAUTION:

Idling the engine with the climate control system off could allow dangerous exhaust into your vehicle. See the earlier caution under *Engine Exhaust on page 130*.

Also, idling in a closed-in place can let deadly carbon monoxide (CO) into your vehicle even if the climate control fan is at the highest setting. One place this can happen is a garage. Exhaust — with CO — can come in easily. **NEVER** park in a garage with the engine running.

Another closed-in place can be a blizzard. See *Winter Driving on page 344*.

### CAUTION:

It can be dangerous to get out of your vehicle if the shift lever is not fully in PARK (P) with the parking brake firmly set. Your vehicle can roll. Do not leave your vehicle when the engine is running unless you have to. If you have left the engine running, the vehicle can move suddenly. You or others could be injured. To be sure your vehicle will not move, even when you are on fairly level ground, always set your parking brake and move the shift lever to PARK (P).

 **CAUTION:**

**If your vehicle has four-wheel drive, it will be free to roll — even if the shift lever is in PARK (P) — if the transfer case is in NEUTRAL. So be sure the transfer case is in a drive gear — not in NEUTRAL. See *Four-Wheel Drive on page 122.***

Follow the proper steps to be sure your vehicle will not move. See *Shifting Into Park (P) on page 127.*

If you are pulling a trailer, see *Towing a Trailer on page 363.*

## Mirrors

### Manual Rearview Mirror

Your vehicle may have this feature. While sitting in a comfortable driving position, adjust the rearview mirror so you can see clearly behind your vehicle. Grip the mirror in the center to move it up or down and side to side. The day/night control, located at the bottom of the mirror, adjusts the mirror to reduce headlamp glare from behind during evening or dark conditions. Turn the control clockwise for night use; return it to the center for daytime use.

### Manual Rearview Mirror with OnStar®

Your vehicle may have a rearview mirror with the OnStar® system.

Control buttons for the OnStar® system are at the bottom of the mirror. See your dealer for more information on the OnStar® system and how to subscribe to OnStar®. Also, see *OnStar® System on page 145* for more information about the services OnStar® provides.

## Mirror Operation

While sitting in a comfortable driving position, adjust the rearview mirror so you can see clearly behind your vehicle. Grip it in the center to move it up or down and side to side. The day/night control, located at the bottom of the mirror, adjusts the mirror to reduce headlamp glare from behind during evening or dark conditions. Move the control to the right for night conditions. Return it to the center for daytime use.

## Automatic Dimming Rearview Mirror with OnStar® and Compass

Your vehicle may have an automatic-dimming rearview mirror with a compass and the OnStar® system.

There are three additional buttons for the OnStar® system. See your dealer for more information on the system and how to subscribe to OnStar®. See *OnStar® System on page 145* for more information about the services OnStar® provides.

 **(On/Off):** This is the on/off button.

## Automatic Dimming Mirror Operation

The automatic dimming mirror function is turned on automatically each time the ignition is started. To operate the automatic dimming mirror, do the following:

1. Make sure the green indicator light, located to the left of the on/off button, is lit. If it's not, press and hold the on/off button until the green light comes on, indicating that the mirror is in automatic dimming mode.
2. Turn off the automatic dimming mirror function by pressing and holding the on/off button until the green indicator light turns off.

## Compass Operation

Press the on/off button once to turn the compass on or off.

There is a compass display in the window in the upper right corner of the mirror face. The compass displays a maximum of two characters. For example, "NE" is displayed for north-east.

## Compass Calibration

Press and hold the on/off button to activate the compass calibration mode. CAL will be displayed in the compass window on the mirror.

The compass can be calibrated by driving the vehicle in circles at 5 mph (8 km/h) or less until the display reads a direction.

## Compass Variance

Compass variance is the difference between earth's magnetic north and true geographic north. The mirror is set to zone eight upon leaving the factory. It will be necessary to adjust the compass to compensate for compass variance if you live outside zone eight. Under certain circumstances, such as during a long distance cross-country trip, it will be necessary to adjust for compass variance. If not adjusted to account for compass variance, your compass could give false readings.

To adjust for compass variance, do the following:

1. Find your current location and variance zone number on the following zone map.

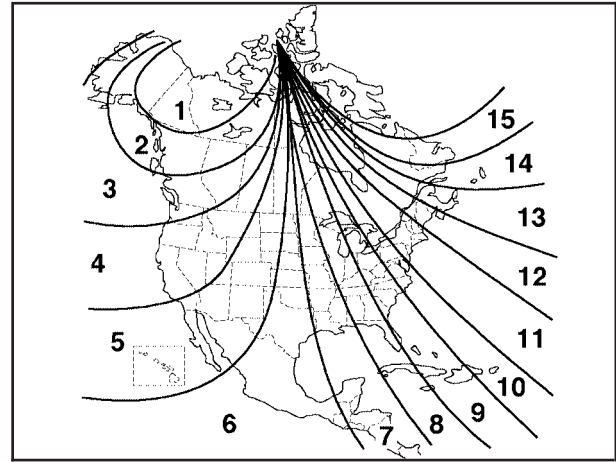

2. Press and hold the on/off button for six seconds. Release the button when (FOR ZONE) is displayed. The number shown is the current zone number.
3. Scroll through the zone numbers that appear in the window on the mirror by pressing the on/off button. Once you find your zone number, release the button. After about four seconds, the mirror will return to the compass display, and the new zone number will be set.

## Automatic Dimming Rearview Mirror with OnStar<sup>®</sup>, Compass and Temperature Display

Your vehicle may have this feature. When on, an automatic dimming mirror automatically dims to the proper level to minimize glare from lights behind you after dark.

The mirror also includes a dual display in the upper right corner of the mirror face. The compass reading and the outside temperature will both appear in the display at the same time.

 **(On/Off):** This is the on/off button.

### Automatic Dimming Mirror Operation

The automatic dimming mirror function is turned on automatically each time the ignition is started. To operate the automatic dimming mirror, do the following:

1. Make sure the green indicator light, located to the left of the on/off button, is lit. If it's not, press and hold the on/off button until the green light comes on, indicating that the mirror is in automatic dimming mode.

2. Turn off the automatic dimming mirror function by pressing and holding the on/off button until the green indicator light turns off.

### Temperature and Compass Display

Press the on/off button, located to the far left, briefly to turn the compass/temperature display on or off.

If the display reads CAL, you will need to calibrate the compass. For more information on calibration, see below.

To adjust between Fahrenheit and Celsius, do the following:

1. Press and hold the on/off button until either a flashing F or C appears.
2. Press the button again to change the display to the desired unit of measurement. After approximately four seconds of inactivity, the new unit will be locked in and the display will return.

If an abnormal temperature reading is displayed for an extended period of time, please consult your dealer. Under certain circumstances, a delay in updating the temperature is normal.

## Compass Variance

The mirror is set in zone eight upon leaving the factory. It will be necessary to adjust the compass to compensate for compass variance if you live outside of zone eight. Under certain circumstances, as during a long distance cross-country trip, it will be necessary to adjust for compass variance. Compass variance is the difference between earth's magnetic north and true geographic north. If not adjusted to account for compass variance, your compass could give false readings.

To adjust for compass variance, do the following:

1. Find your current location and variance zone number on the following zone map.

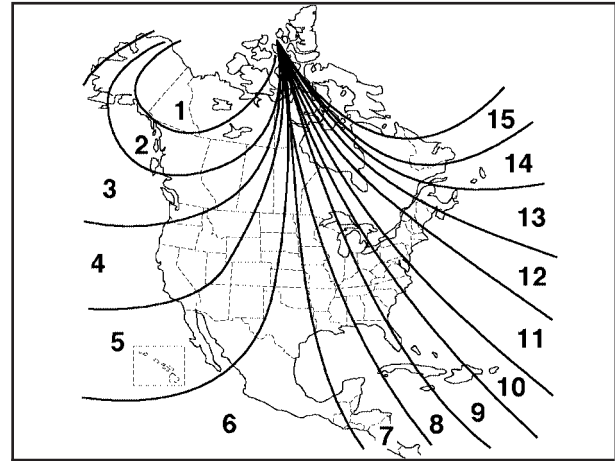

2. Press and hold the on/off button until a Z and a zone number appear in the display. The compass is now in zone mode.
3. Keep pressing the on/off button until the desired zone number appears in the display. Release the button. After approximately four seconds of inactivity, the new zone number will be locked in and the compass/temperature display will return.
4. Calibrate the compass as described next.



## Compass Calibration

The compass may need calibration if one of the following occurs:

- After approximately five seconds, the display does not show a compass heading (N for North, for example), there may be a strong magnetic field interfering with the compass. Such interference may be caused by a magnetic antenna mount, magnetic note pad holder or a similar magnetic item.
- The compass does not display the correct heading and the compass zone variance is set correctly.

In order to calibrate, CAL must be displayed in the mirror compass windows. If CAL is not displayed, press and hold the on/off button until CAL is displayed.

The compass can be calibrated by driving the vehicle in circles at 5 mph (8 km/h) or less until the display reads a direction.

## Passenger Airbag Indicator

The vehicle may be equipped with a passenger airbag indicator, on the mirror glass, just above the buttons. If the vehicle has this feature, the mirror will display the word ON, or an airbag symbol in Canada, when the passenger airbag is enabled. For more information, see *Passenger Sensing System on page 82*.

## Cleaning the Mirror

When cleaning the mirror, use a paper towel or similar material dampened with glass cleaner. Do not spray glass cleaner directly on the mirror as that may cause the liquid cleaner to enter the mirror housing.

## Automatic Dimming Rearview Mirror with Compass

Your vehicle may have an automatic-dimming rearview mirror with a compass.

 **(On/Off):** This is the on/off button for the automatic dimming feature and compass.

### Automatic Dimming Mirror Operation

The automatic dimming mirror function is turned on automatically each time the ignition is started. To operate the automatic dimming mirror, do the following:

1. Make sure the green indicator light, located to the left of the on/off button, is lit. If it's not, press and hold the on/off button until the green light comes on, indicating that the mirror is in automatic dimming mode.
2. Turn off the automatic dimming mirror function by pressing and holding the on/off button until the green indicator light turns off.

## Compass Operation

Press the on/off button once to turn the compass on or off.

There is a compass display in the window in the upper right corner of the mirror face. The compass displays a maximum of two characters. For example, "NE" is displayed for north-east.

### Compass Calibration

Press and hold the on/off button to activate the compass calibration mode. CAL will be displayed in the compass window on the mirror.

The compass can be calibrated by driving the vehicle in circles at 5 mph (8 km/h) or less until the display reads a direction.

## Compass Variance

Compass variance is the difference between earth's magnetic north and true geographic north. The mirror is set to zone eight upon leaving the factory. It will be necessary to adjust the compass to compensate for compass variance if you live outside zone eight. Under certain circumstances, such as during a long distance cross-country trip, it will be necessary to adjust for compass variance. If not adjusted to account for compass variance, your compass could give false readings.

To adjust for compass variance, do the following:

1. Find your current location and variance zone number on the following zone map.

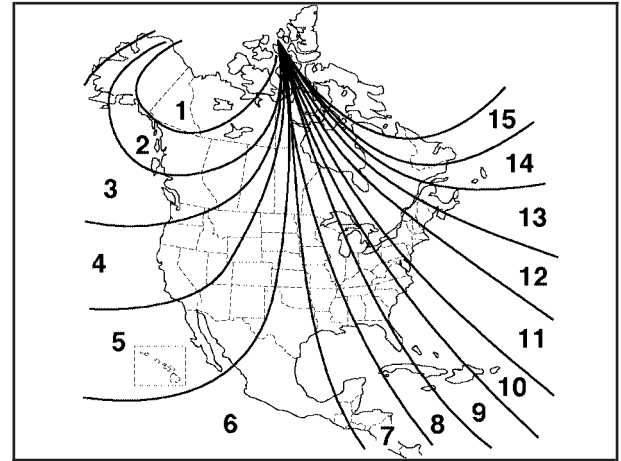

2. Press and hold the on/off button for six seconds. Release the button when (FOR ZONE) is displayed. The number shown is the current zone number.
3. Scroll through the zone numbers that appear in the window on the mirror by pressing the on/off button. Once you find your zone number, release the button. After about four seconds, the mirror will return to the compass display, and the new zone number will be set.

## Automatic Dimming Rearview Mirror with Compass and Temperature Display

If the vehicle is equipped with an automatic mirror, it will, when on, automatically dim to the proper level to minimize glare from lights behind you after dark.

The mirror also includes a display in the upper right corner of the mirror face. The compass reading and the outside temperature will both appear in the display at the same time. The dual display can be turned on or off by briefly pressing either the TEMP or the COMP button.

## Automatic Dimming Mirror Operation

The automatic dimming mirror function is turned on automatically each time the ignition is started.

To operate the automatic dimming mirror, do the following:

1. Make sure the green indicator light, located to the left of the on/off button, is lit. If it's not, press and hold the on/off button until the green light comes on, indicating that the mirror is in automatic dimming mode.
2. Turn off the automatic dimming mirror function by pressing and holding the on/off button until the green indicator light turns off.

## Temperature Display

The temperature can be displayed by pressing the TEMP button. Pressing the TEMP button once briefly, will toggle the temperature reading on and off. To alternate the temperature reading between Fahrenheit and Celsius, press and hold the TEMP button until the display blinks F and C. Press and release the TEMP button to toggle between the Fahrenheit and Celsius readings. After approximately four seconds of inactivity, the display will stop blinking and display the last selection made.

If an abnormal reading is displayed, for an extended period of time, please consult your dealer. Under certain circumstances, a delay in updating the temperature is normal.

## Compass Operation

Press the COMP button once briefly to turn the compass on or off.

When the ignition and the compass feature are on, the compass will show two character boxes for approximately two seconds. After two seconds, the mirror will display the compass heading.

## Compass Calibration

The compass may need calibration if one of the following occurs:

- If CAL is displayed while driving in the vehicle.
- After approximately five seconds, the display does not show a compass heading (N for North, for example), there may be a strong magnetic field interfering with the compass. Such interference may be caused by a magnetic antenna mount, magnetic note pad holder or a similar magnetic item.
- The compass does not display the correct heading and the compass zone variance is set correctly.

In order to calibrate, CAL must be displayed in the mirror compass windows. If CAL is not displayed, press and hold the COMP button until CAL is displayed.

The compass can be calibrated by driving the vehicle in circles at 5 mph (8 km/h) or less until the display reads a direction.

## Compass Variance

The mirror is set in zone eight upon leaving the factory. It will be necessary to adjust the compass to compensate for compass variance if you live outside zone eight. Under certain circumstances, as during a long distance cross-country trip, it will be necessary to adjust for compass variance. Compass variance is the difference between earth's magnetic north and true geographic north. If not adjusted to account for compass variance, your compass could give false readings.

To adjust for compass variance, do the following:

1. Find your current location and variance zone number on the following zone map.
2. Press and hold the COMP button until a zone number appears in the display.
3. Press the COMP button on the bottom of the mirror until the new zone number appears in the display. After you stop pressing the button, the display will show a compass direction within a few seconds.

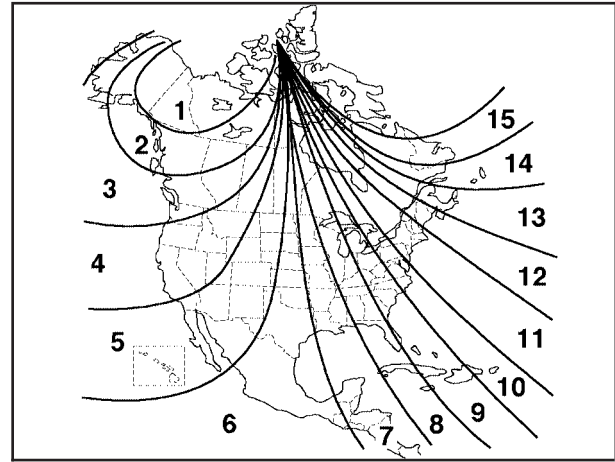

## Passenger Airbag Indicator

The mirror may be equipped with a passenger airbag indicator on the mirror glass, just above the buttons. If the vehicle has this feature the mirror will display the word ON, or an airbag symbol in Canada, when the passenger airbag is enabled. For more information see *Passenger Sensing System on page 82*.

## Cleaning the Mirror

When cleaning the mirror, use a paper towel or similar material dampened with glass cleaner. Do not spray glass cleaner directly on the mirror as that may cause the liquid cleaner to enter the mirror housing.

## Outside Manual Mirrors

If the vehicle has the manual outside mirrors, adjust each outside mirror so that a little of the vehicle and the area behind it can be seen while sitting in a comfortable, driving position.

Both mirrors can be manually folded inward by pulling them towards the vehicle. Push the mirrors away from the vehicle, to the normal position, before driving.

## Outside Power Mirrors

Your vehicle may have this feature. The power mirror control is located on the driver's door.

Turn the knob counterclockwise or clockwise to adjust the driver's or passenger's mirror so that you can see a little of the side of your vehicle. After adjusting the position of the mirrors, turn the knob to the center position so that the mirrors cannot move.

If the travel position in any direction of the mirror is reached, it will enter a ratcheting mode. This action is harmless. It is a warning that the mirror can go no further. To stop this action, back the mirror up by moving the knob in the opposite direction.

The mirrors can be manually folded inward to prevent damage when going through an automatic car wash. To fold, push the mirror toward the vehicle. To return the mirror to its original position, push outward. Be sure to return both mirrors to their original unfolded position before driving.

## Outside Curb View Assist Mirror

If the vehicle has this feature, the passenger's outside mirror will adjust to a preset tilt position while the vehicle is in REVERSE (R) gear. Curb view assist may be useful when you are parallel parking. The mirror will return to normal position when the vehicle is shifted out of REVERSE (R) gear. Automatic mirror movement in either direction will follow a short delay.

You may be able to turn this feature on or off through the Driver Information Center (DIC). See *DIC Vehicle Customization on page 226*.

## Outside Convex Mirror

### CAUTION:

**A convex mirror can make things (like other vehicles) look farther away than they really are. If you cut too sharply into the right or left lane, you could hit a vehicle. Check your inside mirror or glance over your shoulder before changing lanes.**

The passenger's outside mirror is convex. A convex mirror's surface is curved so more can be seen from the driver's seat.



## Outside Heated Mirrors

If the vehicle has this feature, when the rear window defogger is turned on, the outside driver's and passenger's rearview mirrors also heat to help clear them of ice, snow, and condensation. See *Dual Climate Control System on page 185* or *Dual Automatic Climate Control System on page 188* for more information.

## OnStar® System

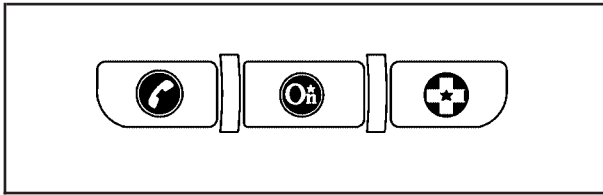

OnStar® uses several innovative technologies and live advisors to provide you with a wide range of safety, security, information, and convenience services. If your airbags deploy, the system is designed to make an automatic call to OnStar® Emergency advisors who can request emergency services be sent to your location. If you lock your keys in the vehicle, call OnStar® at

1-888-4-ONSTAR and they can send a signal to unlock your doors. If you need roadside assistance, press the OnStar® button and they can contact Roadside Service for you.

OnStar® service is provided to you subject to the OnStar® Terms and Conditions. You may cancel your OnStar® service at any time by contacting OnStar® as provided below. A complete OnStar® Owner's Guide and the OnStar® Terms and Conditions are included in the vehicle's OnStar® Subscriber glove box literature. For more information, visit [onstar.com](http://onstar.com) or [onstar.ca](http://onstar.ca), contact OnStar® at 1-888-4-ONSTAR (1-888-466-7827) or TTY 1-877-248-2080, or press the OnStar® button to speak with an OnStar® advisor 24 hours a day, 7 days a week.

Not all OnStar® features are available on all vehicles. To check if your vehicle is equipped to provide the services described below, or for a full description of OnStar® services and system limitations, see the OnStar® Owner's Guide in your glove box or visit [onstar.com](http://onstar.com).

## OnStar® Services

For new vehicles equipped with OnStar®, the Safe & Sound Plan, or the Directions & Connections® Plan is included for one year from the date of purchase. You can extend this plan beyond the first year, or upgrade to the Directions & Connections® Plan. For more information, press the OnStar® button to speak with an advisor. Some OnStar® services (such as Remote Door Unlock or Stolen Vehicle Location Assistance) may not be available until you register with OnStar®.

### Available Services with Safe & Sound® Plan

- Automatic Notification of Airbag Deployment
- Advanced Automatic Crash Notification (AACN) (If equipped)
- Link to Emergency Services
- Roadside Assistance
- Stolen Vehicle Location Assistance
- AccidentAssist

- Remote Door Unlock/Vehicle Alert
- OnStar® Vehicle Diagnostics
- GM® Goodwrench® On Demand Diagnostics
- OnStar® Hands-Free Calling with 30 complimentary minutes
- OnStar® Virtual Advisor

### Available Services included with Directions & Connections® Plan

- All Safe and Sound Plan Services
- Driving Directions - Advisor delivered or OnStar® Turn-by-Turn Navigation (If equipped)
- RideAssist
- Information and Convenience Services

## OnStar® Hands-Free Calling

OnStar® Hands-Free Calling allows eligible OnStar® subscribers to make and receive calls using voice commands. Hands-Free Calling is fully integrated into the vehicle, and can be used with OnStar® Pre-Paid Minute Packages. Hands-Free Calling may also be linked to a Verizon Wireless service plan, depending on eligibility. To find out more, refer to the OnStar® Owner's Guide in the vehicle's glove box, visit [www.onstar.com](http://www.onstar.com) or [www.onstar.ca](http://www.onstar.ca), or speak with an OnStar® advisor by pressing the OnStar® button or calling 1-888-4-ONSTAR (1-888-466-7827).

## OnStar® Virtual Advisor

OnStar® Virtual Advisor is a feature of OnStar® Hands-Free Calling that uses your minutes to access location-based weather, local traffic reports, and stock quotes. By pressing the phone button and giving a few simple voice commands, you can browse through the various topics. See the OnStar® Owner's Guide for more information.

## OnStar® Steering Wheel Controls

Your vehicle may have a Talk/Mute button that can be used to interact with OnStar® Hands-Free Calling. See *Audio Steering Wheel Controls on page 294* for more information.

On some vehicles, you may have to hold the button for a few seconds and give the command "ONSTAR" in order to activate the OnStar® Hands-Free Calling feature.

On some vehicles, the mute button can be used to dial numbers into voicemail systems, or to dial phone extensions. See the OnStar® Owner's Guide for more information.

## How OnStar® Service Works

In order to provide you with OnStar® services, your vehicle's OnStar® system has the capability of recording and transmitting vehicle information. This information is automatically sent to an OnStar® Call Center at the time of an OnStar® button press, Emergency button press or if your airbags or AACN system deploys. The vehicle information usually includes your GPS location and, in the event of a crash, additional information regarding the accident that your vehicle has been involved in (e.g. the direction from which your vehicle was hit). When you use the Virtual Advisor feature of OnStar® Hands-Free Calling, your vehicle also sends OnStar® your GPS location so that we can provide you with location-based services.

OnStar® service cannot work unless your vehicle is in a place where OnStar® has an agreement with a wireless service provider for service in that area. OnStar® service also cannot work unless you are in a place where the wireless service provider OnStar® has hired for that area has coverage, network capacity and reception when the service is needed, and technology that

is compatible with the OnStar® service. Not all services are available everywhere, particularly in remote or enclosed areas, or at all times.

OnStar® service that involves location information about your vehicle cannot work unless GPS satellite signals are unobstructed and available in that place as well.

Your vehicle must have a working electrical system (including adequate battery power) for the OnStar® equipment to operate. There are other problems OnStar® cannot control that may prevent OnStar® from providing OnStar® service to you at any particular time or place. Some examples are damage to important parts of your vehicle in an accident, hills, tall buildings, tunnels, weather or wireless phone network congestion.

## Your Responsibility

You may need to increase the volume of your radio to hear the OnStar® advisor. If the light next to the OnStar® buttons is red, this means that your system is not functioning properly and should be checked by a dealer. If the light appears clear (no light is appearing), your OnStar® subscription has expired. You can always press the blue OnStar® button to confirm that your OnStar® equipment is active.

# Universal Home Remote System

## Universal Home Remote System (With Three Round LED)

The Universal Home Remote System provides a way to replace up to three hand-held Radio-Frequency (RF) transmitters used to activate devices such as garage door openers, security systems, and home lighting.

This device complies with Part 15 of the FCC Rules. Operation is subject to the following two conditions:

1. This device may not cause harmful interference.
2. This device must accept any interference received, including interference that may cause undesired operation.

The FCC Grant of Equipment Authorization Certificate number is KOBGTE05A.

This device complies with RSS-210 of Industry Canada. Operation is subject to the following two conditions:

1. This device may not cause interference.
2. This device must accept any interference received, including interference that may cause undesired operation of the device.

The Canadian Registration ID number is 3521A-GTE05A.

Changes or modifications to this system by other than an authorized service facility could void authorization to use this equipment.

## Universal Home Remote System (With One Triangular LED)

The Universal Home Remote System provides a way to replace up to three hand-held radio-frequency (RF) transmitters used to activate devices such as garage door openers, security systems, and home lighting.

This device complies with Part 15 of the FCC Rules. Operation is subject to the following two conditions:

1. This device may not cause harmful interference.
2. This device must accept any interference received, including interference that may cause undesired operation.

The FCC Grant of Equipment Authorization Certificate number is CB2SAHL3.

This device complies with RSS-210 of Industry Canada. Operation is subject to the following two conditions:

1. This device may not cause interference.
2. This device must accept any interference received, including interference that may cause undesired operation of the device.

The Canadian Registration ID number is 2791021849A.

Changes or modifications to this system by other than an authorized service facility could void authorization to use this equipment.

## Universal Home Remote System Operation (With Three Round LED)

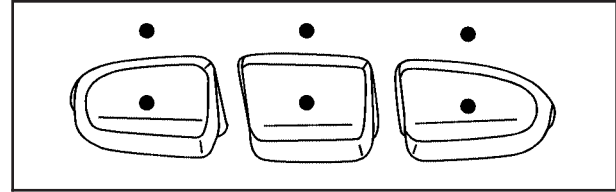

Your vehicle may have the Universal Home Remote System. If there are three round Light Emitting Diode (LED) above the Universal Home Remote System buttons, follow the instructions below. If there is one triangular LED above the Universal Home Remote System buttons, follow the instructions under Universal Home Remote System Operation (with one triangular LED).

This system provides a way to replace up to three remote control transmitters used to activate devices such as garage door openers, security systems, and home lighting.

Do not use this system with any garage door opener that does not have the stop and reverse feature. This includes any garage door opener model manufactured before April 1, 1982.

Read the instructions completely before attempting to program the transmitter. Because of the steps involved, it may be helpful to have another person available to assist you in programming the transmitter.

Be sure to keep the original remote control transmitter for use in other vehicles, as well as, for future programming. You only need the original remote control transmitter for fixed code programming. It is also recommended that upon the sale or lease termination of the vehicle, the programmed buttons should be erased for security purposes. See “Erasing your Universal Home Remote Buttons” later in this section.

Be sure that people and objects are clear of the garage door or security device you are programming. When programming a garage door, it is advised to park outside of the garage.

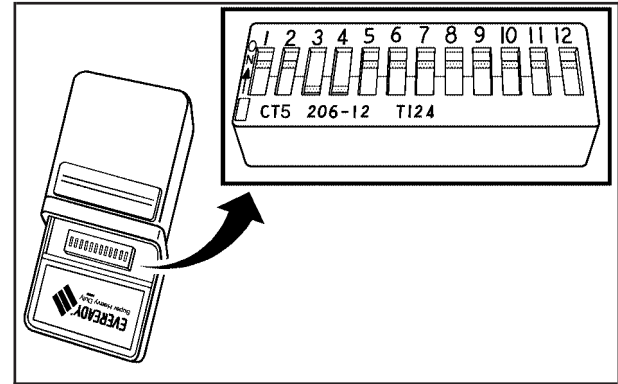

If you do not know if your garage door opener is a fixed code or rolling code device, open your garage door opener's remote control battery cover. Your garage door opener is a fixed code device if there is a panel of switches. If not, your garage door opener is a rolling code device.

## Programming Universal Home Remote — Fixed Code

Fixed Code garage door openers are used for garage doors produced prior to 1996. Fixed code uses the same coded signal every time, which is manually programmed by setting DIP switches for a unique personal code.

Follow these steps to program up to three channels:

1. Remove the battery cover of the hand-held transmitter.

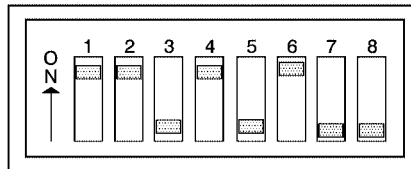

Switch Number	1	2	3	4	5	6	7	8
Switch Position	On	On	Off	On	Off	On	Off	Off

### Example of Switch Settings

2. Write down the eight to 12 coding switch settings from left to right. When the switch is in the up position, write “on,” and when a switch is in the down position, write “off”. If a switch is set between the up and down position, write “middle”.
3. Enter these positions into the Universal Home Remote System as follows.

Press and release all three buttons at the same time to put the device into programming mode.



Switch Number	1	2	3	4	5	6	7	8
Switch Position	On	On	Off	On	Off	On	Off	Off
Your UHR Button	Left	Left	Right	Left	Right	Left	Right	Right

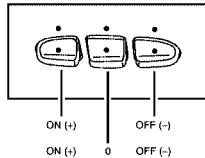

### Example

- The indicator light will blink slowly. In order from left to right, and within two and one-half minutes, enter each switch setting into the Universal Home Remote System. Push one button for each switch as follows:
  - Left button = “on” switch position.
  - Right button = “off” switch position.
  - Middle button = “middle” switch position.
- After entering the switch settings, press and release all three buttons at the same time. The indicator lights will turn on.

- Press and hold the button you would like to use to control the garage door until the garage door moves. The indicator light above the selected button should slowly blink. You may need to hold the button from five to 55 seconds.
- Immediately release the button when the garage door moves. The indicator light will blink rapidly until programming is complete.
- Press and release the button again. The garage door should move, confirming that programming is successful and complete.

To program another device such as an additional garage door opener, a security device, or home lighting, repeat Steps 1 through 8, choosing a different function button in Step 7 than what you used for the garage door opener.

## Programming Universal Home Remote — Rolling Code

Rolling code garage door openers are used for garage doors produced after 1996 and are code protected. Rolling code means the coded signal is changed every time your remote control garage door opener is used.

Programming a rolling code garage door opener involves time-sensitive actions, so read the entire procedure before you begin. If you do not follow these actions, the device will time out and you will have to repeat the procedure.

Follow these steps to program up to three channels:

1. Press the two outside buttons at the same time for one to two seconds, and immediately release them.

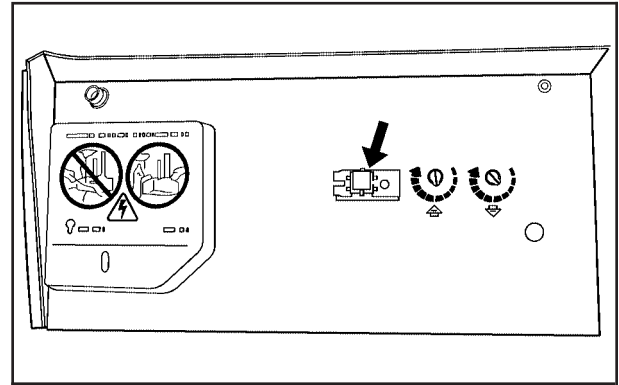

2. Go to the garage. Locate the garage door motor head and press and release the “learn” button.

After pressing the “learn” button, you have 10 to 30 seconds to complete Step 4 depending on your garage control unit. If you cannot locate the “learn” button, refer to the owners guide for your garage door opener.

3. Press and hold the button you would like to use to control the garage door until the garage door moves. The indicator light, above the selected button, should slowly blink. You may need to hold the button from five to 20 seconds.
4. Immediately release the button when the garage door moves. The indicator light will blink rapidly until programming is complete.
5. Press and release the button again. The garage door should move, confirming that programming is successful and complete.

To program another device such as an additional garage door opener, a security device, or home lighting, repeat Steps 1 through 6, choosing a different function button in Step 4 than what you used for the garage door opener.

## Using Universal Home Remote

Press and hold the appropriate button for at least half of a second. The indicator light will come on while the signal is being transmitted.

## Reprogramming Universal Home Remote Buttons

You can reprogram any of the three buttons by repeating the instructions.

## Erasing Universal Home Remote Buttons

You should erase the programmed buttons when you sell the vehicle or terminate your lease.

To erase either rolling code or fixed code on the Universal Home Remote device, do the following:

1. Press and hold the two outside buttons at the same time for approximately 20 seconds, until the indicator lights, located directly above the buttons, begin to blink rapidly.
2. Once the indicator lights begin to blink, release both buttons. The codes from all button will be erased.

For additional information on Universal Home Remote, see *Customer Assistance Offices on page 540*.

## Universal Home Remote System Operation (With One Triangular LED)

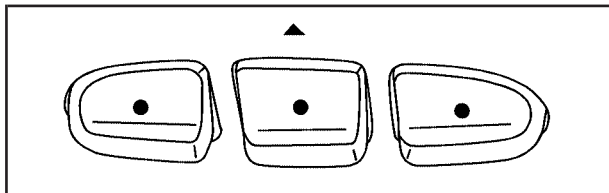

Your vehicle may have the Universal Home Remote System. If there is one triangular Light Emitting Diode (LED) above the Universal Home Remote buttons, follow the instructions below. If your vehicle has three round LED above the Universal Home Remote buttons, follow the instructions under Universal Home Remote System Operation (with three round LED).

Do not use the Universal Home Remote with any garage door opener that does not have the stop and reverse feature. This includes any garage door opener model manufactured before April 1, 1982. If you have a newer garage door opener with rolling

codes, please be sure to follow Steps 6 through 8 to complete the programming of your Universal Home Remote Transmitter.

Read the instructions completely before attempting to program the Universal Home Remote. Because of the steps involved, it may be helpful to have another person available to assist you in the programming steps.

Keep the original hand-held transmitter for use in other vehicles as well as for future Universal Home Remote programming. It is also recommended that upon the sale of the vehicle, the programmed Universal Home Remote buttons should be erased for security purposes. See “Erasing Universal Home Remote Buttons” later in this section or, for assistance, see *Customer Assistance Offices on page 540*.

Be sure that people and objects are clear of the garage door or gate operator you are programming. When programming a garage door, it is advised to park outside of the garage.

It is recommended that a new battery be installed in your hand-held transmitter for quicker and more accurate transmission of the radio-frequency signal.

## Programming Universal Home Remote

Follow these steps to program up to three channels:

1. Press and hold down the two outside Universal Home Remote buttons, releasing only when the Universal Home Remote indicator light begins to flash, after 20 seconds. Do not hold down the buttons for longer than 30 seconds and do not repeat this step to program a second and/or third hand-held transmitter to the remaining two Universal Home Remote buttons.
2. Position the end of your hand-held transmitter about 1 to 3 inches (3 to 8 cm) away from the Universal Home Remote buttons while keeping the indicator light in view.
3. Simultaneously press and hold both the desired Universal Home Remote button and the hand-held transmitter button. Do not release the buttons until Step 4 has been completed.

Some entry gates and garage door openers may require you to substitute Step 3 with the procedure noted in “Gate Operator and Canadian Programming” later in this section.

4. The indicator light will flash slowly at first and then rapidly after Universal Home Remote successfully receives the frequency signal from the hand-held transmitter. Release both buttons.
5. Press and hold the newly-trained Universal Home Remote button and observe the indicator light.

If the indicator light stays on continuously, programming is complete and your device should activate when the Universal Home Remote button is pressed and released.

To program the remaining two Universal Home Remote buttons, begin with Step 2 under “Programming Universal Home Remote.” Do not repeat Step 1 as this will erase all of the programmed channels.

If the indicator light blinks rapidly for two seconds and then turns to a constant light, continue with Steps 6 through 8 following to complete the programming of a rolling-code device, most commonly, a garage door opener.

6. Locate in the garage, the garage door opener receiver (motor-head unit). Locate the “Learn” or “Smart” button. This can usually be found where the hanging antenna wire is attached to the motor-head unit.
7. Firmly press and release the “Learn” or “Smart” button. The name and color of the button may vary by manufacturer.

You will have 30 seconds to start Step 8.

8. Return to the vehicle. Firmly press and hold the programmed Universal Home Remote button for two seconds, then release. Repeat the press/hold/release sequence a second time, and depending on the brand of the garage door opener or other rolling code device, repeat this sequence a third time to complete the programming.

The Universal Home Remote should now activate the rolling-code device.

To program the remaining two Universal Home Remote buttons, begin with Step 2 of “Programming Universal Home Remote.” Do not repeat Step 1, as this will erase all previous programming from the Universal Home Remote buttons.

## Gate Operator and Canadian Programming

Canadian radio-frequency laws require transmitter signals to time out or quit after several seconds of transmission. This may not be long enough for Universal Home Remote to pick up the signal during programming. Similarly, some U.S. gate operators are manufactured to time out in the same manner.

If you live in Canada, or you are having difficulty programming a gate operator or garage door opener by using the “Programming Universal Home Remote” procedures, regardless of where you live, replace Step 3 under “Programming Universal Home Remote” with the following:

Continue to press and hold the Universal Home Remote button while you press and release every two seconds (cycle) the hand-held transmitter button until the frequency signal has been successfully accepted by the Universal Home Remote. The Universal Home Remote indicator light will flash slowly at first and then rapidly. Proceed with Step 4 under “Programming Universal Home Remote” to complete.

## Using Universal Home Remote

Press and hold the appropriate Universal Home Remote button for at least half of a second. The indicator light will come on while the signal is being transmitted.

## Erasing Universal Home Remote Buttons

To erase programming from the three Universal Home Remote buttons do the following:

1. Press and hold down the two outside buttons until the indicator light begins to flash, after 20 seconds. Do not hold the two outside buttons for longer than 30 seconds.
2. Release both buttons.

The Universal Home Remote is now in the training (learning) mode and can be programmed at any time beginning with Step 2 under “Programming Universal Home Remote” shown earlier in this section.

Individual buttons cannot be erased, but they can be reprogrammed. See “Reprogramming a Single Universal Home Remote Button” following this section.

## Reprogramming a Single Universal Home Remote Button

To program a device to Universal Home Remote using a Universal Home Remote button previously trained, follow these steps:

1. Press and hold the desired Universal Home Remote button. Do not release the button.
2. The indicator light will begin to flash after 20 seconds. While still holding the Universal Home Remote button, proceed with Step 2 under “Programming Universal Home Remote” shown earlier in this section.

For additional information on Universal Home Remote, see *Customer Assistance Offices on page 540*.

## Storage Areas

### Glove Box

To open, pull up on the handle. Use the key to lock and unlock.

### Overhead Console

Your vehicle may have this feature. The overhead console may include reading lamps, a Universal Home Remote and a sunroof switch. See *Sunroof on page 164* and *Universal Home Remote System (With Three Round LED) on page 149* or *Universal Home Remote System (With One Triangular LED) on page 149* for more information.

## Center Console Storage Area

Squeeze the front lever on the center console while lifting the top to open it.

Your vehicle's console will have cupholders located on the front and rear of the storage compartment.

The console may also contain one or more of the following components:

- Rear Seat Audio Controls
- Rear Seat Accessory Power Outlets
- Rear Climate Control

To open the center armrest compartment, lift the cover by pulling up on the latch handle located underneath the front edge of the armrest.



## Luggage Carrier

### CAUTION:

**If you try to carry something on top of your vehicle that is longer or wider than the luggage carrier — like paneling, plywood, a mattress and so forth — the wind can catch it as you drive along. This can cause you to lose control. What you are carrying could be violently torn off, and this could cause you or other drivers to have a collision, and of course damage your vehicle. You may be able to carry something like this inside. But, never carry something longer or wider than the luggage carrier on top of your vehicle.**

If your vehicle has a luggage carrier, it will allow you to load things on top of your vehicle. The luggage carrier has side rails attached to the roof, places to use for tying things down and may

have sliding crossrails. These let you load some other things on top of your vehicle, as long as they are not wider or longer than the luggage carrier.

To slide the crossrails to where you want them, pull up on the lever on each side of the crossrail. This releases the crossrail and allows you to slide it. When the crossrail is where you want it, press down on the levers to lock it into place.

**Notice:** Loading cargo on the luggage carrier that weighs more than 220 lbs (100 kg) or hangs over the rear or sides of the vehicle may damage your vehicle. Load cargo so that it rests on the slats as far forward as possible and against the side rails, making sure to fasten it securely.

Do not exceed the maximum vehicle capacity when loading your vehicle. For more information on vehicle capacity and loading, see *Loading Your Vehicle on page 350*.

To prevent damage or loss of cargo as you are driving, check now and then to make sure the luggage carrier is locked and cargo is still securely fastened.

When the luggage carrier is not in use, place the crossrails at the following positions for wind noise reduction. Place one crossrail at the rear most point of the vehicle and the other crossrail above the opening of the rear door.

## Rear Floor Storage Lid

### CAUTION:

**If any removable convenience item is not secured properly, it can move around in a collision or sudden stop. People in the vehicle could be injured. Be sure to secure any such item properly.**

Your vehicle has a rear cargo area with a removable storage lid.

To remove the rear floor storage lid, do the following:

1. Press the latch release and lift up the latch handle.
2. Raise the lid slightly to unhook it.
3. Pull the lid toward you to release it from the forward mounting tabs.

To reinstall the rear floor storage lid, reverse the previous steps. Make sure the lid is secure by applying slight pressure to the latch until you hear it click.

## Convenience Net

Your vehicle may have this feature. A convenience net in the rear of your vehicle helps keep small items in place during sharp turns or quick stops and starts. The net is not designed to retain these items during off-road use. The net is not for larger, heavier items.

To use the convenience net, do the following:

1. Attach the upper loops to the retainers on both sides of the liftgate opening. The label should be in the upper passenger's side corner, visible from the rear of the vehicle.
2. Attach the lower hooks to the rear cargo tie downs on the floor.

## Cargo Cover

If your vehicle has a cargo cover, you can use it to cover items in the cargo area of your vehicle.

To install the cargo cover, do the following:

1. Align the endcap with the pocket in the trim panel located behind the rear seat.
2. Squeeze the opposite endcap, align it with the pocket located on the opposite side of the trim panel and release.
3. Grasp the handle and unroll the cover.
4. Latch the posts into the sockets on the inside of the vehicle to secure it.

To remove the cargo cover, do the following:

1. Release the cover from the latch posts and carefully roll it back up.
2. Squeeze one endcap and remove it from the pocket in the trim panel.
3. Remove the cargo cover from the other endcap so that you can remove the shade from the vehicle.

### CAUTION:

**An improperly stored cargo cover could be thrown about the vehicle during a collision or sudden maneuver. You or others could be injured. If you remove the cover, always store it in the proper storage location. When you put it back, always be sure that it is securely reattached.**

## Cargo Tie Downs

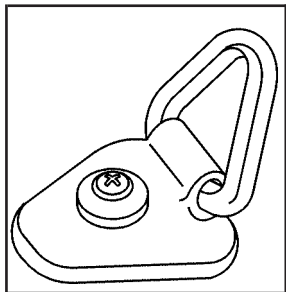

There are cargo tie downs in the rear of your vehicle that allow you to strap cargo in and keep it from moving.

## Sunroof

The vehicle may be equipped with a power sliding sunroof. To open or close the sunroof, the ignition must be turned to RUN, ACCESSORY, or Retained Accessory Power (RAP) must be active. See *Retained Accessory Power (RAP)* on page 114.

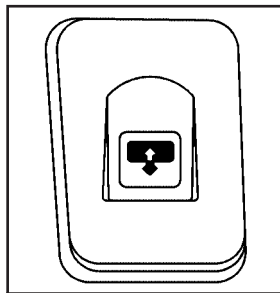

Press and release the back of the control in the overhead console to open the sunroof. Press the front of the control to close the sunroof.

Once the sunroof is closed, press the forward side of the control to open the sunroof to the vent position.

The sunroof has a sunshade which can be pulled forward to block sun rays. If it is in the closed position, it will open when the sunroof is opened.

## Section 3 Instrument Panel

---

<b>Instrument Panel Overview</b> .....	168	Reading Lamps .....	182
Hazard Warning Flashers .....	170	Electric Power Management .....	182
Other Warning Devices .....	170	Battery Run-Down Protection .....	183
Horn .....	170	Accessory Power Outlet(s) .....	183
Tilt Wheel .....	170	Ashtray(s) and Cigarette Lighter .....	184
Turn Signal/Multifunction Lever .....	171	<b>Climate Controls</b> .....	185
Turn and Lane-Change Signals .....	171	Dual Climate Control System .....	185
Headlamp High/Low-Beam Changer .....	172	Dual Automatic Climate Control System .....	188
Flash-to-Pass .....	172	Outlet Adjustment .....	192
Windshield Wipers .....	173	Rear Climate Control System .....	193
Windshield Washer .....	173	<b>Warning Lights, Gages, and Indicators</b> .....	195
Rear Window Wiper/Washer .....	174	Instrument Panel Cluster .....	196
Cruise Control .....	174	Speedometer and Odometer .....	197
Headlamps .....	178	Trip Odometer .....	197
Headlamps on Reminder .....	178	Tachometer .....	197
Daytime Running Lamps (DRL) .....	179	Safety Belt Reminder Light .....	198
Automatic Headlamp System .....	179	Passenger Safety Belt Reminder Light .....	198
Fog Lamps .....	180	Airbag Readiness Light .....	199
Instrument Panel Brightness .....	181	Passenger Airbag Status Indicator .....	200
Dome Lamps .....	181	Charging System Light .....	203
Dome Lamp Override .....	181		
Entry Lighting .....	182		
Exit Lighting .....	182		

## Section 3 Instrument Panel

---

Voltmeter Gage .....	203	<b>Driver Information Center (DIC)</b> .....	216
Brake System Warning Light .....	204	DIC Operation and Displays .....	217
Anti-Lock Brake System		DIC Warnings and Messages .....	220
Warning Light .....	205	DIC Vehicle Customization .....	226
StabiliTrak® Service Light .....	206	<b>Audio System(s)</b> .....	234
StabiliTrak® Indicator Light .....	206	Setting the Time .....	236
Engine Coolant Temperature Gage .....	207	Radio with CD (Base) .....	236
Tire Pressure Light .....	207	Radio with CD (MP3) .....	246
Malfunction Indicator Lamp .....	208	Radio with Six-Disc CD .....	255
Oil Pressure Gage .....	211	Using an MP3 .....	268
Change Engine Oil Light .....	212	XM Radio Messages .....	274
Security Light .....	212	Navigation/Radio System .....	277
Cruise Control Light .....	213	Rear Seat Entertainment System .....	277
Reduced Engine Power Light .....	213	Rear Seat Audio (RSA) .....	292
Highbeam On Light .....	213	Theft-Deterrent Feature .....	293
Service Four-Wheel Drive		Audio Steering Wheel Controls .....	294
Warning Light .....	214	Radio Reception .....	295
Check Gages Warning Light .....	214	Care of Your CDs and DVDs .....	296
Gate Ajar Light .....	214	Care of the CD and DVD Player .....	296
Fuel Gage .....	215	Fixed Mast Antenna .....	296
Low Fuel Warning Light .....	215	XM™ Satellite Radio Antenna System .....	297
Check Gas Cap Light .....	215	Chime Level Adjustment .....	297



# NOTES

---

---

---

---

---

---

---

---

---

---

---

---

---

---

---

---

---

---

---

---

---

---

---

---

# Instrument Panel Overview

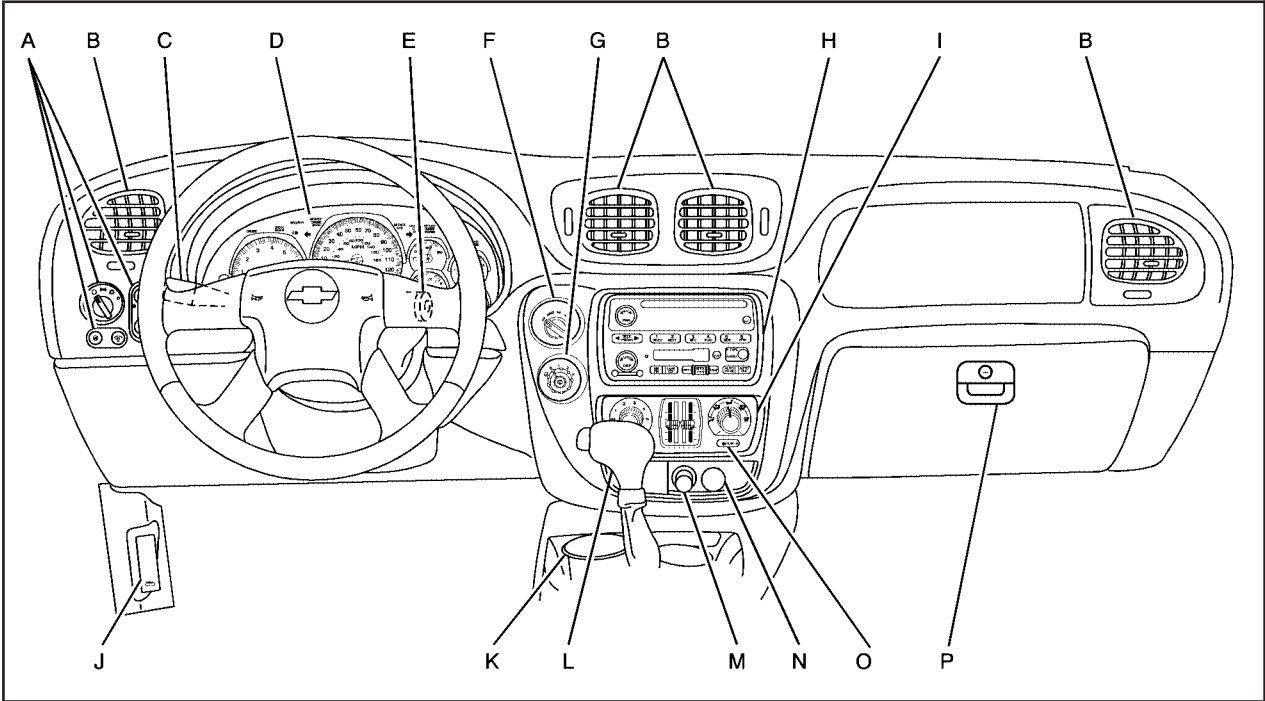



The main components of your instrument panel are the following:

- A. Exterior Lamp Control. See *Headlamps on page 178*. Dome Lamp Override Button. See *Dome Lamp Override on page 181*. Instrument Panel Brightness Control. See *Instrument Panel Brightness on page 181*. Fog Lamp Button (If Equipped). See *Fog Lamps on page 180*.
- B. Air Outlets. See *Outlet Adjustment on page 192*.
- C. Turn Signal/Multifunction Lever. See *Turn Signal/Multifunction Lever on page 171*.
- D. Instrument Panel Cluster. See *Instrument Panel Cluster on page 196*.
- E. Ignition Switch. See *Ignition Positions on page 113*.
- F. Transfer Case Controls. See “Automatic Transfer Case” under *Four-Wheel Drive on page 122*.
- G. Rear Window Washer/Wiper. See *Windshield Washer on page 173*.
- H. Audio System. See *Audio System(s) on page 234*.
- I. Climate Controls. See *Dual Climate Control System on page 185*.
- J. Hood Release. See *Hood Release on page 390*.
- K. Ashtray. See *Ashtray(s) and Cigarette Lighter on page 184*.
- L. Shift Lever and StabiliTrak<sup>®</sup> Button. See *Shifting Into Park (P) on page 127* and *StabiliTrak<sup>®</sup> System on page 307*.
- M. Lighter. See *Ashtray(s) and Cigarette Lighter on page 184*.
- N. Accessory Power Outlet. See *Accessory Power Outlet(s) on page 183*.
- O. Rear Window Defogger. See “Rear Window Defogger” under *Dual Climate Control System on page 185* and *Dual Automatic Climate Control System on page 188*.
- P. Glove Box. See *Glove Box on page 160*.

## Hazard Warning Flashers

The hazard warning flashers warn others. They also let police know you have a problem. Your front and rear turn signal lamps will flash on and off.

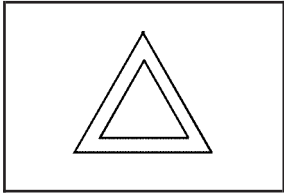

The hazard warning flasher button is located on top of the steering column.

The hazard warning flashers work no matter what ignition position the key is in, and even if the key is not in the ignition.

Press the button to make the front and rear turn signal lamps flash on and off. Press the button again to turn the flashers off.

When the hazard warning flashers are on, your turn signals will not work.

## Other Warning Devices

If you carry reflective triangles, you can set them up at the side of the road about 300 feet (100 m) behind your vehicle.

## Horn

To sound the horn, press the horn symbols on the steering wheel pad.

## Tilt Wheel

The steering wheel should be adjusted before you drive.

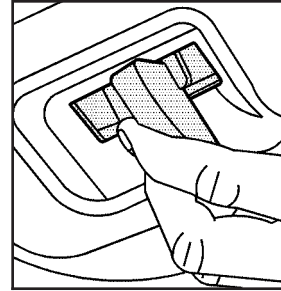

The tilt lever is located to the left of the steering column, under the turn signal lever.



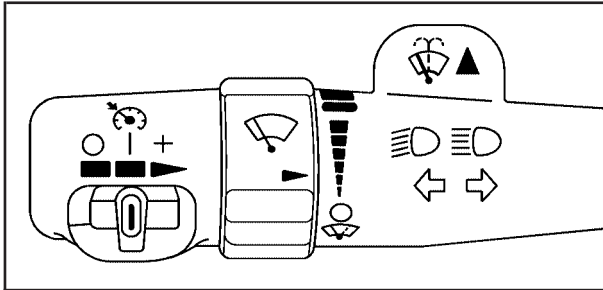

It can be raised to the highest level to give your legs more room when you enter and exit the vehicle.

To tilt the wheel, hold the steering wheel and pull the lever toward you. Move the steering wheel to a comfortable level, then release the lever to lock the wheel in place.

## Turn Signal/Multifunction Lever



The lever on the left side of the steering column includes the following:

-  Turn and Lane Change Signals
-  Headlamp High/Low-Beam Changer
- Flash-to-Pass Feature
-  Windshield Wipers
-  Windshield Washer
-  Cruise Control

## Turn and Lane-Change Signals

The turn signal has two upward (for right) and two downward (for left) positions. These positions let you signal a turn or a lane change.

To signal a turn, move the lever all the way up or down. When the turn is finished, the lever returns automatically.

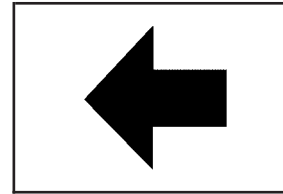

An arrow on the instrument panel cluster flashes in the direction of the turn or lane change.

To signal a lane change, raise or lower the lever until the arrow starts to flash. Hold it there until you complete your lane change. The lever returns by itself when released. The bottom of the outside rearview mirrors might also have lane change indicators.

As you signal a turn or a lane change, if the arrows flash more quickly than normal, a signal bulb could be burned out and other drivers will not see your turn signal.

If a bulb is burned out, replace it to help avoid an accident. If the arrows do not go on at all when you signal a turn, check the fuse. See *Fuses and Circuit Breakers on page 501* and check for burned-out bulbs.

If you have a trailer towing option with added wiring for the trailer lamps, a turn signal flasher is used. With this flasher installed, the signal indicator flashes even if a turn signal bulb is burned out. Check the front and rear turn signal lamps regularly to make sure they are working.

### Turn Signal On Chime

If your turn signal is left on for more than 3/4 of a mile (1.2 km), a chime sounds at each flash of the turn signal. To turn off the chime, move the turn signal lever to the off position.

### Headlamp High/Low-Beam Changer

To change the headlamps from low to high beam, push the lever toward the instrument panel. To return to low-beam headlamps, pull the multifunction lever toward you. Then release it.

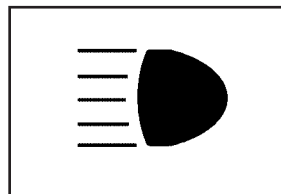

When the high beams are on, this indicator light on the instrument panel cluster will also be on.

### Flash-to-Pass

This feature lets you use your high-beam headlamps to signal a driver in front of you that you want to pass. It works even if your headlamps are in the automatic position.

To use it, pull the turn signal lever toward you, then release it.

If the headlamps are in the automatic position or on low beam, the high-beam headlamps turn on. They will stay on as long as you hold the lever toward you. The high-beam indicator on the instrument panel cluster comes on. Release the lever to return to normal operation.

## Windshield Wipers

 **(Mist):** Turn the band to mist, for a single wiping cycle. Hold it there until the wipers start. Then let go. The wipers will stop after one wipe. If more wipes are needed, hold the band on mist longer.

 **(Off):** Move the band to off, to stop the wipers.

 **(Windshield Wipers):** Turn the band to control the windshield wipers.

The wiper speed can be set for a long or short delay between wipes. This can be very useful in light rain or snow. Turn the band to choose the delay time. The closer to the top of the lever, the shorter the delay.

For steady wiping at low speed, turn the band away from you to the first solid band past the delay settings. For high-speed wiping, turn the band further, to the second solid band past the delay settings. To stop the wipers, move the band to off.

Be sure to clear ice and snow from the wiper blades before using them. If they are frozen to the windshield, carefully loosen or thaw them. If the blades do become worn or damaged, get new blades or blade inserts.

## Windshield Washer

 **(Windshield Washer):** To spray washer fluid on the windshield, press the windshield washer paddle. The wipers will clear the window and then either stop or return to your preset speed.

### CAUTION:

**In freezing weather, do not use your washer until the windshield is warmed. Otherwise the washer fluid can form ice on the windshield, blocking your vision.**

## Rear Window Wiper/Washer

### CAUTION:

In freezing weather, do not use your washer until the windshield is warmed. Otherwise the washer fluid can form ice on the windshield, blocking your vision.

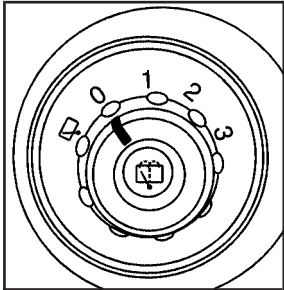

This control is located to the right of the steering wheel on the instrument panel.

To turn the rear wiper on, turn the control to either 1, 2, or 3. For delayed wiping, turn the control to 1 or 2. For steady wiping, turn the control to 3. To turn the wiper off, turn the control to 0.

To wash the rear window, press the washer symbol located in the center of the control.

The rear window washer uses the same fluid bottle as the windshield washer. However, the rear window washer will run out of fluid before the windshield washer. If you can wash your windshield but not your rear window, check the fluid level.

## Cruise Control

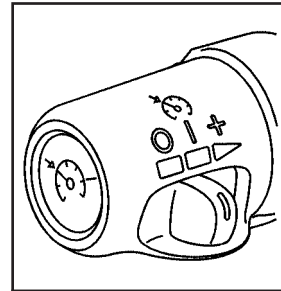

Your vehicle has cruise control. The controls are located on the end of the turn signal/multifunction lever.

**I (On):** Move the switch to this position to turn the cruise control system on.

**+ (Resume/Accelerate):** Move the switch to this position to resume a set speed or to accelerate.

 **(Set):** Press this button, located at the end of the lever, to set a speed.

**(Off):** Move the switch to this position to turn the cruise control system off and cancel memory of a set speed.

With cruise control, you can maintain a speed of about 25 mph (40 km/h) or more without keeping your foot on the accelerator. This can really help on long trips. Cruise control does not work at speeds below about 25 mph (40 km/h).

If you apply the brakes, the cruise control shuts off.

 **CAUTION:**

**Cruise control can be dangerous where you cannot drive safely at a steady speed. So, do not use your cruise control on winding roads or in heavy traffic.**

**CAUTION: (Continued)**

**CAUTION: (Continued)**

**Cruise control can be dangerous on slippery roads. On such roads, fast changes in tire traction can cause excessive wheel slip, and you could lose control. Do not use cruise control on slippery roads.**

 **CAUTION:**

**If you leave your cruise control on when you are not using cruise, you might hit a button and go into cruise when you do not want to. You could be startled and even lose control. Keep the cruise control switch off until you want to use cruise control.**

## Setting Cruise Control

1. Move the cruise control switch to on.
2. Get up to the speed you want.
3. Press the set button at the end of the lever and release it.
4. Take your foot off the accelerator pedal. The accelerator pedal will not go down.

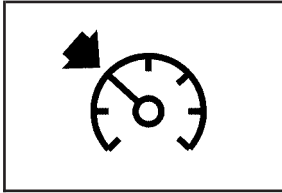

Some vehicles have a cruise light on the instrument panel cluster that will come on when the cruise control is engaged.

## Resuming a Set Speed

Suppose you set your cruise control at a desired speed and then you apply the brake. This, of course, shuts off the cruise control. But you do not need to reset it.

Once you are going about 25 mph (40 km/h) or more, you can move the cruise control switch briefly from on to resume/accelerate.

You will go right back up to the previously chosen speed and stay there.

If you hold the switch at resume/accelerate, the vehicle keeps going faster until you release the switch or apply the brakes. So unless you want to go faster, do not hold the switch at resume/accelerate.

## Increasing Speed While Using Cruise Control

There are two ways to go to a higher speed:

- Use the accelerator pedal to get to the higher speed. Press the button at the end of the lever, then release the button and the accelerator pedal. You will now cruise at the higher speed.
- Move the cruise switch from on to resume/accelerate. Hold it there until you get up to the desired speed and then release the switch. To increase your speed in very small amounts, move the switch briefly to resume/accelerate. Each time you do this, your vehicle will go about 1 mph (1.6 km/h) faster.



## **Reducing Speed While Using Cruise Control**

Press in the set button at the end of the lever until you reach the desired speed, then release it. Each time you do this, you will go about 1 mph (1.6 km/h) slower.

## **Passing Another Vehicle While Using Cruise Control**

Use the accelerator pedal to increase your speed. When you take your foot off the pedal, your vehicle will slow down to the cruise control speed set earlier.

## **Using Cruise Control on Hills**

How well your cruise control works on hills depends upon your speed, load and the steepness of the hills. When going up steep hills, you may want to step on the accelerator pedal to maintain

your speed. When going downhill, you may have to brake or shift to a lower gear to keep your speed down. Of course, applying the brake takes you out of cruise control. Many drivers find this to be too much trouble and do not use cruise control on steep hills.

## **Ending Cruise Control**

There are three ways to turn off the cruise control:

- Step lightly on the brake pedal.
- Move the cruise switch to off, or
- Shift the transmission to NEUTRAL (N).

## **Erasing Speed Memory**

When you turn off the cruise control or the ignition, the cruise control set speed memory is erased.

## Headlamps

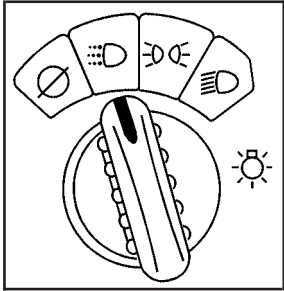

The exterior lamps knob is located on your instrument panel to the left of the steering wheel.

**⊘ (Off):** Turn the knob to this symbol and release it to turn off the Daytime Running Lamps (DRL) and the Automatic Headlamps (AHS). An indicator illuminates when the position is selected. This position is not available for vehicles first sold in Canada.

**☰ (Automatic DRL/AHS):** Turn the knob to this symbol to put the system into automatic headlamp mode. An indicator comes on when the position is selected.

**☰ (Parking Lamps):** Turn the knob to this symbol to turn on the parking lamps, as well as the following:

- Sidemarker Lamps
- Taillamps
- License Plate Lamps
- Instrument Panel Lights

**☰ (Headlamps):** Turn the knob to this symbol to turn on the headlamps, as well as the following:

- Parking Lamps
- Sidemarker Lamps
- Taillamps
- License Plate Lamps
- Instrument Panel Lights

## Headlamps on Reminder

A reminder tone sounds when the headlamps or parking lamps are manually turned on, if the driver's door is open and the ignition is in LOCK or ACC. To turn the tone off, turn the knob all the way counterclockwise.

In the automatic mode, the headlamps turn off once the ignition key is in LOCK.

## Daytime Running Lamps (DRL)

Daytime Running Lamps (DRL) can make it easier for others to see the front of your vehicle during the day. DRL can be helpful in many different driving conditions, but they can be especially helpful in the short periods after dawn and before sunset. Fully functional DRL are required on all vehicles first sold in Canada.

The DRL system makes the headlamps come on at reduced brightness when the following conditions are met:

- The ignition is on.
- The exterior lamps knob is in automatic headlamp mode.
- The light sensor detects daytime light.
- The transmission is not in PARK (P).

When the DRL are on, only the headlamps will be on. The taillamps, sidemarker and other lamps will not be on. The instrument panel will not be lit up either.

When it begins to get dark, the headlamps automatically switch from DRL to the regular headlamps.

## Automatic Headlamp System

When it is dark enough outside, the Automatic Headlamp System turns on the headlamps when the vehicle is started and after the transaxle has been shifted out of the PARK (P) position. The headlamps, taillamps, sidemarker, and parking lamps will come on. The instrument panel lights and radio lights will also turn on at normal brightness. Once on, the system remains on during these conditions even if the vehicle is shifted back into PARK (P).

The vehicle has a light sensor on the top of the instrument panel. Make sure it is not covered or the system may come on whenever the ignition is on and the vehicle is shifted out of the PARK (P) position.

The system could also turn on the lamps when driving through a parking garage, heavy overcast weather or a tunnel. This is normal.

There is a delay in the transition between the daytime and nighttime operation of the Daytime Running Lamps (DRL) and the automatic headlamp systems, so that driving under bridges or bright overhead street lights does not affect the system. The DRL and automatic headlamp system are only affected when the light sensor sees a change in lighting lasting longer than the delay.

If you start your vehicle in a dark garage, the automatic headlamp system comes on after the transmission is shifted out of PARK (P). Once you leave the garage, it will take about one minute for the automatic headlamp system to change to DRL if it is light outside. During that delay, the instrument panel cluster might not be as bright as usual. Make sure the instrument panel brightness control is in the full bright position.

If the vehicle is running and the automatic headlamp system is already on, it can be turned off by turning and releasing the headlamp control at the off position. The automatic headlamp system stays off until you turn and release the headlamp control at the off position again. See *Headlamps on page 178*.

## Fog Lamps

Your vehicle may have this feature. Use your fog lamps for better vision in foggy or misty conditions. Your ignition must be in RUN for your fog lamps to work.

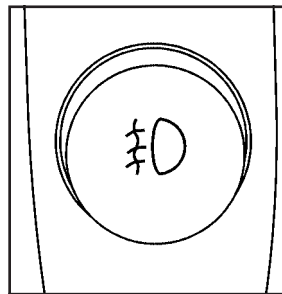

The fog lamp button is located on the instrument panel to the right of the exterior lamps knob.

Press the button to turn the fog lamps on. Press the button again to turn them off. A light will glow near the button while the fog lamps are on. Fog lamps will turn off whenever your high-beam headlamps are on.

Some localities have laws that require the headlamps to be on along with the fog lamps.

## Instrument Panel Brightness

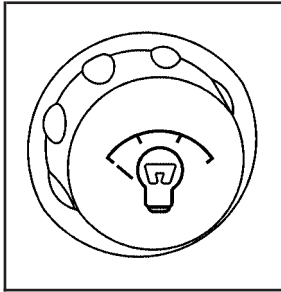

Press the knob located next to the exterior lamps knob to extend it.

Turn the knob to adjust the instrument panel lights. Turn the knob all the way up to turn on the interior lamps. Press the knob back into its stored position when you are not using it.

## Dome Lamps

The dome lamps will come on when you open a door unless the dome lamp override is pressed in.

## Dome Lamp Override

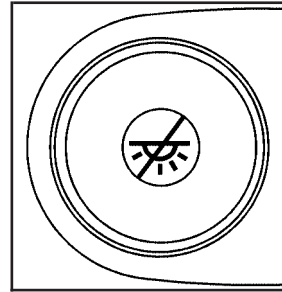

The dome override button is located below the exterior lamps knob.

To turn the dome lamps off, press the button. The dome lamps will remain off when a door is open. This will override the illuminated entry feature unless you use the Remote Keyless Entry (RKE) transmitter to unlock the vehicle.

To return the lamps to automatic operation, press the button again. The dome lamps come on when a door is opened.

## Entry Lighting

The vehicle has entry lighting.

When any door is opened, the dome lamps come on as long as the dome override lamp override button is not pressed in. When all the doors are closed, the lamps stay on for a short period of time and then turn off automatically. If you use the Remote Keyless Entry (RKE) transmitter to unlock the vehicle, the interior lamps come on for a short time whether or not the dome lamp override is on.

## Exit Lighting

With exit lighting, the interior lamps come on when you remove the key from the ignition. If the dome override is off, these lamps stay on for a short period of time and then go out.

## Reading Lamps

The reading lamps are located in the front console.

Press the lens on the lamps to turn the reading lamps on or off.

## Electric Power Management

This vehicle has Electric Power Management (EPM), an advanced control system. It estimates the battery's temperature and state of charge and then adjusts the voltage for best performance and extended life of the battery.

When the battery's state of charge is low, the voltage is raised slightly to quickly put the charge back in. When the state of charge is high, the voltage is lowered slightly to prevent overcharging. If the vehicle has a voltmeter gage, you may see the voltage move up or down. This is normal. If there is a problem, an alert will be displayed.

The battery can be discharged at idle if the electrical loads are very high. This is true for all vehicles. This is because the generator (alternator) may not be spinning fast enough at idle to produce all the power that is needed for very high electrical loads.

A high electrical load occurs when several of the following loads are on: headlamps, high beams, fog lamps, rear window defogger, climate control fan at high speed, heated seats, engine cooling fans, trailer loads, and loads plugged into accessory power outlets.

EPM works to prevent excessive discharge of the battery. It does this by balancing the generator's output and the vehicle's electrical needs. It can increase engine idle speed to generate more power, whenever needed. It can temporarily reduce the power demands of some accessories.

Normally, these actions occur in steps or levels, without being noticeable. In rare cases at the highest levels of corrective action, this action may be noticeable to the driver. If so, a Driver Information Center (DIC) message might be displayed, such as Battery Saver Active or Battery Voltage Low. If this message is displayed, it is recommended that the driver reduce the electrical loads as much as possible. See *DIC Warnings and Messages on page 220*.

## Battery Run-Down Protection

This feature shuts off the dome, courtesy, and vanity lamps if they are left on for more than 20 minutes when the ignition is off. This will keep the battery from running down.

If the battery run-down protection shuts off the interior lamps, it may be necessary to do one of the following to return to normal operation:

- Shut off all lamps and close all doors.
- Turn the ignition key to RUN.

This feature will also turn off the parking lamps and headlamps under most circumstances, if they are left on. If you would like to turn them back on, turn the exterior lamps knob.

## Accessory Power Outlet(s)

With the accessory power outlets, you can plug in auxiliary electrical equipment such as a cellular telephone or CB radio.

Your vehicle has three accessory power outlets. There are two outlets located below the climate controls and one outlet is on the rear of the center floor console.

Remove the cover from the outlet to use the outlet. Be sure to put the cover back on when not using the accessory power outlet.

Certain electrical accessories may not be compatible with the accessory power outlet and could result in blown vehicle or adaptor fuses.

If you experience a problem, see your dealer for additional information on the accessory power outlets.

**Notice:** Adding any electrical equipment to your vehicle may damage it or keep other components from working as they should. The repairs would not be covered by your warranty. Do not use equipment exceeding maximum amperage rating of 20 amperes. Check with your dealer before adding electrical equipment.

When adding electrical equipment, be sure to follow the proper installation instructions included with the equipment.

**Notice:** Improper use of the power outlet can cause damage not covered by your warranty. Do not hang any type of accessory or accessory bracket from the plug because the power outlets are designed for accessory power plugs only.

## Ashtray(s) and Cigarette Lighter

Your vehicle may have this feature. The ashtray is removable and fits into the front cupholder.

**Notice:** If you put papers, pins, or other flammable items in the ashtray, hot cigarettes or other smoking materials could ignite them and possibly damage your vehicle. Never put flammable items in the ashtray.

To remove the ashtray, pull the covered bin out of the cupholder.

To use the lighter, press it in all the way, and let go. When it is ready, it will pop back out by itself.

**Notice:** Holding a cigarette lighter in while it is heating will not allow the lighter to back away from the heating element when it is hot. Damage from overheating may occur to the lighter or heating element, or a fuse could be blown. Do not hold a cigarette lighter in while it is heating. Do not use equipment exceeding maximum amperage rating of 20 amperes.



# Climate Controls

## Dual Climate Control System

With this system you can control the heating, cooling, and ventilation for your vehicle.

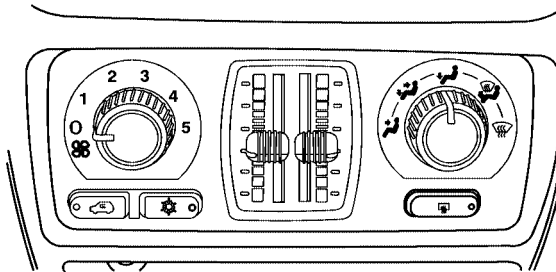



 **(Fan):** Turn the left knob clockwise or counterclockwise to increase or decrease the fan speed. If the knob is in off mode, outside air still enters the vehicle, and is directed based on the position of the mode knob. The temperature can still be adjusted using the temperature knob.

Turn the right knob clockwise or counterclockwise to direct the airflow inside of your vehicle.

To change the current mode, select one of the following:

 **(Vent):** This mode directs air to the instrument panel outlets.

 **(Bi-Level):** This mode directs about half of the air to the instrument panel outlets; then directs most of the remaining air to the floor outlets. A little air is directed toward the windshield and the side window outlets. Cooler air is directed to the upper vents and warmer air to the floor outlets.

 **(Floor):** This mode directs most of the air to the floor outlets with a little air directed to the windshield and the side window outlets. The recirculation button cannot be selected while in floor mode.

 **(Recirculation):** Recirculation mode is used to recirculate the air inside of your vehicle. When this button is pressed, an indicator light in the button will come on to let you know that it is active. Use this mode to help prevent outside odors and/or dust from entering your vehicle or to help cool the air inside of your vehicle more quickly. The air conditioning compressor will also come on when this mode is activated. While in recirculation mode, the windows may fog when the weather is cold and damp. To clear the fog, select either the defog or defrost mode and increase fan speed.

Defog and defrost modes are described later in this section.

**Driver's Side Temperature Lever:** The lever on the left side of the climate control panel is used to raise or lower the temperature on the driver's side of the vehicle. Slide the lever up or down to adjust the temperature.

**Passenger's Side Temperature Lever:** The lever on the right side of the climate control panel is used to raise or lower the temperature on the passenger's side of the vehicle. Slide the lever up or down to adjust the temperature. This lever also adjusts the temperature to the rear seat outlets.

When the temperature outside is 0°F (-18°C) or lower, use the engine coolant heater, if the vehicle has one, to provide warmer air, faster to your vehicle.

 **(Air Conditioning):** Press this button to turn the air-conditioning system on or off. When the button is pressed, an indicator light will come on and the system will begin to cool and dehumidify the air inside of the vehicle. You may notice a slight change in engine performance when the air conditioning compressor shuts off and turns on again. This is normal.

## Defogging and Defrosting

Fog on the inside of windows is a result of high humidity (moisture) condensing on the cool window glass. This can be minimized if the climate control system is used properly. There are two modes to choose from to clear fog or frost from your windshield. Use the defog mode to clear the windows of fog or moisture and warm the passengers. Use the defrost mode to remove fog or frost from the windshield more quickly.

Turn the right knob clockwise or counterclockwise to select one of the following modes:

 **(Defog):** This mode directs the air to the floor outlets, windshield and side window outlets. The recirculation button cannot be selected while in defog mode.

 **(Defrost):** This mode directs most of the air to the windshield and the side window outlets, with only a little air directed to the floor outlets. The air conditioning compressor may run to dehumidify the air to prevent window fogging. The recirculation button cannot be selected while in defrost mode. Do not drive the vehicle until all the windows are clear.

## Rear Window Defogger

If your vehicle has the rear window defogger a warming grid is used to remove fog on the rear window.

 **(Rear):** Press this button to turn the rear window defogger on or off. An indicator light in the button will come on to let you know that the rear window defogger is active. The rear window defogger will automatically turn off approximately ten minutes after the button is pressed.

If your vehicle has heated mirrors, this button will activate them.

**Notice:** Do not use anything sharp on the inside of the rear window. If you do, you could cut or damage the warming grid, and the repairs would not be covered by your warranty. Do not attach a temporary vehicle license, tape, a decal or anything similar to the defogger grid.

## Dual Automatic Climate Control System

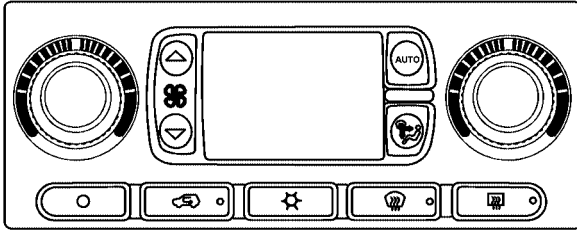

With this system you can control the heating, cooling and ventilation for your vehicle. When your vehicle is first started and the climate control system is on, or if the climate control system has been turned on, the display will show the driver's temperature setting for five seconds. Then it will show the outside temperature.

**(Off):** Press this button to turn off the entire climate control system. Outside air will still enter the vehicle, and will be directed to the floor. Press the AUTO button, the mode button, the fan arrows, or either temperature knob to turn the system on.

**(Mode):** Press this button to manually select the air delivery mode to the floor, instrument panel, or windshield outlets. The system will stay in the selected mode until the mode button is pressed again or the AUTO button is pressed.

**Driver's Side Temperature Knob:** Turn this knob clockwise or counterclockwise to raise or lower the temperature on the driver's side of the vehicle. The display will show the temperature setting decreasing or increasing and an arrow pointing toward the driver. This knob can also adjust the passenger's side temperature setting if the two are linked.

**Passenger's Side Temperature Knob:** Turn this knob clockwise or counterclockwise to manually raise or lower the temperature on the passenger's side of the vehicle. The display will show the temperature setting decreasing or increasing and an arrow pointing toward the passenger. The passenger's temperature setting can be set to match and link to the driver's temperature setting by pressing and holding the AUTO button for three seconds. When adjusting the driver's side temperature setting, the passenger's side temperature setting will follow and both arrows will appear on the display.

The passenger's side temperature setting also resets and relinks to the driver's side temperature setting if the vehicle has been off for more than three hours.

## Outside Air Temperature Display

A new outside temperature reading will be displayed if the vehicle has been off for more than three hours. If the vehicle has been off for less than three hours, the old temperature reading may be displayed because underhood heat is affecting the true outside temperature. Underhood heat can also affect the outside temperature while the engine is running. It may also take several minutes of driving before the display updates to the actual outside temperature.

## Automatic Operation

**AUTO (Automatic):** When automatic operation is active, the system will control the inside temperature, the air delivery mode, and the fan speed.

Use the steps below to place the entire system in automatic mode:

1. Press the AUTO button.

When AUTO is selected, the air conditioning operation and air outlet mode will be automatically controlled. The air conditioning compressor will run continuously when the outside temperature is over approximately 40°F (4°C). The air inlet will normally be set to outside air. If it's hot outside, the air inlet will automatically switch to recirculate inside air to help quickly cool down your vehicle.

2. Set the driver's and passenger's temperature.

To find your comfort setting, start with a 72°F (22°C) temperature setting and allow about 20 minutes for the system to adjust. Turn the driver's or passenger's side temperature knob to adjust the temperature setting as necessary. If you choose the temperature setting of 60°F (15°C), the system will remain at the maximum cooling setting. If you choose the temperature setting of 90°F (32°C), the system will remain at the maximum heat setting. Choosing either maximum setting may not cause the vehicle to heat or cool any faster.

## Manual Operation

To change the current setting, select one of the following:

 **(Fan):** This button allows you to manually adjust the fan speed. Press the up arrow to increase fan speed and the down arrow to decrease fan speed. The display will change to show you the selected fan speed and the driver's side temperature setting for five seconds.

 **(Mode):** Press this button to manually change the direction of the airflow in your vehicle. Keep pressing the button until the desired mode appears on the display. The display will change to show you the selected air delivery mode and the driver's temperature setting for five seconds.

 **(Vent):** This mode directs air to the instrument panel outlets.

 **(Bi-Level):** This mode directs approximately half of the air to the instrument panel outlets, then directs the remaining air to the floor outlets. A little air is directed toward the windshield and the side window outlets. Cooler air is directed to the upper outlets and warmer air to the floor outlets.

 **(Floor):** This mode directs most of the air to the floor outlets. Some air also comes out of the defroster and side window outlets. The recirculation button cannot be selected in floor mode.

 **(Recirculation):** Press this button to turn recirculation mode on or off. When this button is pressed, an indicator light in the button will also come on to let you know that it is activated. Recirculation mode is used to recirculate the air inside of your vehicle. Use this mode to help prevent outside odors and/or dust from entering your vehicle or to help cool the air inside of your vehicle more quickly. Recirculation mode can be used with vent and bi-level modes, but it cannot be used with floor, defog or defrost modes. Defog and defrost modes are described later in this section.

If recirculation mode is selected with floor, defog, or defrost modes, the indicator will flash three times and then turn off indicating the selection is not available.

You may also notice that the air conditioning compressor will run while in recirculation mode. This is normal and will help to prevent fogging.

If the weather is cold and damp, the system may cause the windows to fog while using recirculation mode. If the windows do start to fog, select defog or defrost mode and increase fan speed.

Recirculation mode, if selected, will be cleared when the engine is turned off.

 **A/C (Air Conditioning):** Press this button to manually turn the air conditioning system on or off. When the system is on, the system will automatically begin to cool and dehumidify the air inside of your vehicle. The air conditioning symbol will appear on the display when the air conditioning is on and will turn off when the air conditioning is off.

If you turn the air conditioning off while in front defrost or defog mode, the air conditioning symbol will turn off, however, the A/C compressor will remain on to help de-humidify the air inside the vehicle. If one of the other modes is selected the compressor will then turn the A/C off until it is selected again or the AUTO button is pressed.

To avoid fogging the inside glass on rainy and humid days at a temperature above freezing, press the air conditioning button to run the A/C compressor. Also it is best to avoid the use of the

recirculation mode except when maximum air conditioning performance is needed or for short times to avoid exterior odors.

You may notice a slight change in engine performance when the air-conditioning compressor shuts off and turns on again. This is normal.

## Defogging and Defrosting

Fog on the inside of the windows is a result of moisture condensing on the cool window glass. This can be reduced if the climate control system is used properly. You can use either defog or front defrost to clear fog or frost from your windshield.

 **(Defog):** Use this setting to clear the windows of fog or moisture. This setting will deliver air to the floor and windshield outlets.

 **(Front Defrost):** Press the front defrost button to clear the windshield and side windows of frost or fog quickly. The system will automatically control the fan speed if you select defrost from AUTO mode. If the outside temperature is 40°F (4°C) or warmer, your air conditioning compressor will automatically run to help dehumidify the air and dry the windshield. Do not drive the vehicle until all the windows are clear.

## Rear Window Defogger

If your vehicle has the rear window defogger a warming grid is used to remove fog from the rear window.

 **(Rear):** Press this button to turn the rear window defogger on or off.

An indicator light in the button will come on to let you know that the rear window defogger is activated.

The rear window defogger will turn off approximately 10 minutes after the button is pressed. If you need additional warming time, press the button again.

If your vehicle has heated mirrors, they will come on when this button is pressed.

**Notice:** Do not use a razor blade or sharp object to clear the inside rear window. Do not adhere anything to the defogger grid lines in the rear glass. These actions may damage the rear defogger. Repairs would not be covered by your warranty.

## Outlet Adjustment

Use the air outlets located in the center and on the side of the instrument panel to direct the airflow.

### Operation Tips

- Keep the hood and front air inlets free of ice, snow, or any other obstruction, such as leaves. The heater and defroster will work better, reducing the chance of fogging the inside of your windows.
- When you enter a vehicle in cold weather, set the fan speed to maximum airflow for a few moments before driving. This helps clear the intake ducts of snow and moisture, and reduces the chance of fogging the inside of your windows.
- Keep the air path under the front seats clear of objects. This helps air to circulate throughout your vehicle.
- Adding outside equipment to the front of the vehicle, such as hood-air deflectors, may affect the performance of the heating and air conditioning system. Check with your dealer before adding equipment to the outside of your vehicle.



## Rear Climate Control System

Your vehicle has one of the following rear climate control systems. With either of these systems, the rear climate controls will be disabled when the front climate control system is in defrost. This occurs to provide maximum airflow to clear the windshield.

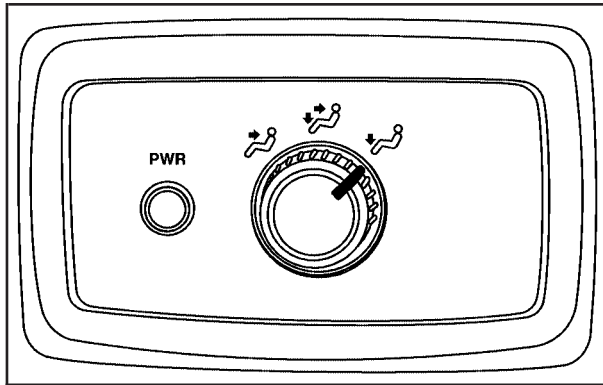

The temperature of the air coming through the rear outlets is determined by the front passenger's temperature setting. Use the mode knob to change the direction of airflow (upper, bi-level or floor) to the rear seat area.

**PWR (Power):** Press this button to turn the rear climate controls on or off.

**Panel (Panel):** When panel mode is selected, the rear system will distribute air from the four headliner outlets.

**Bi-level (Bi-level):** When bi-level mode is selected, the rear system will distribute air from the four headliner outlets, the second seat side floor outlets, and the third seat floor outlet.

**Floor (Floor):** When floor mode is selected, the rear system will distribute air from the second seat side floor outlets and the third seat floor outlet.

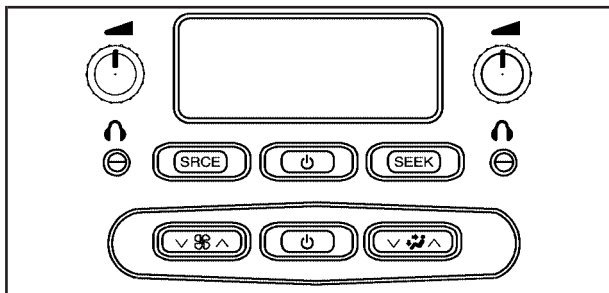

If your vehicle has the rear seat audio system, the lower buttons are used to adjust the rear seat climate control system. The temperature of the air coming through the rear outlets is determined by the front passenger's temperature setting.

**⏻ (On/Off):** Press this button to turn the rear climate controls on or off.

**⏻ ⚙ ⤴ (Fan):** Press this button to adjust the fan speed.

**⏻ ⚙ ⤴ (Mode):** Press this button to change the direction of airflow (panel, bi-level or floor) to the rear seat area.

The rear control will only turn on if the front is on and not in defrost mode.

## Warning Lights, Gages, and Indicators

This part describes the warning lights and gages that may be on your vehicle. The pictures will help you locate them.

Warning lights and gages can signal that something is wrong before it becomes serious enough to cause an expensive repair or replacement. Paying attention to your warning lights and gages could also save you or others from injury.

Warning lights come on when there may be or is a problem with one of your vehicle's functions. As you will see in the details on the next few pages, some warning lights come on briefly when you start the engine just to let you know they're working. If you are familiar with this section, you should not be alarmed when this happens.

Gages can indicate when there may be or is a problem with one of your vehicle's functions. Often gages and warning lights work together to let you know when there's a problem with your vehicle.

When one of the warning lights comes on and stays on when you are driving, or when one of the gages shows there may be a problem, check the section that tells you what to do about it. Please follow this manual's advice.

Waiting to do repairs can be costly—and even dangerous. So please get to know your warning lights and gages. They're a big help.

Your vehicle may also have a Driver Information Center (DIC) that works along with the warning lights and gages. See *Driver Information Center (DIC)* on page 216.

## Instrument Panel Cluster

Your instrument panel cluster is designed to let you know at a glance how your vehicle is running. You will know how fast you are going, about how much fuel you have used, and many other things you will need to know to drive safely and economically.

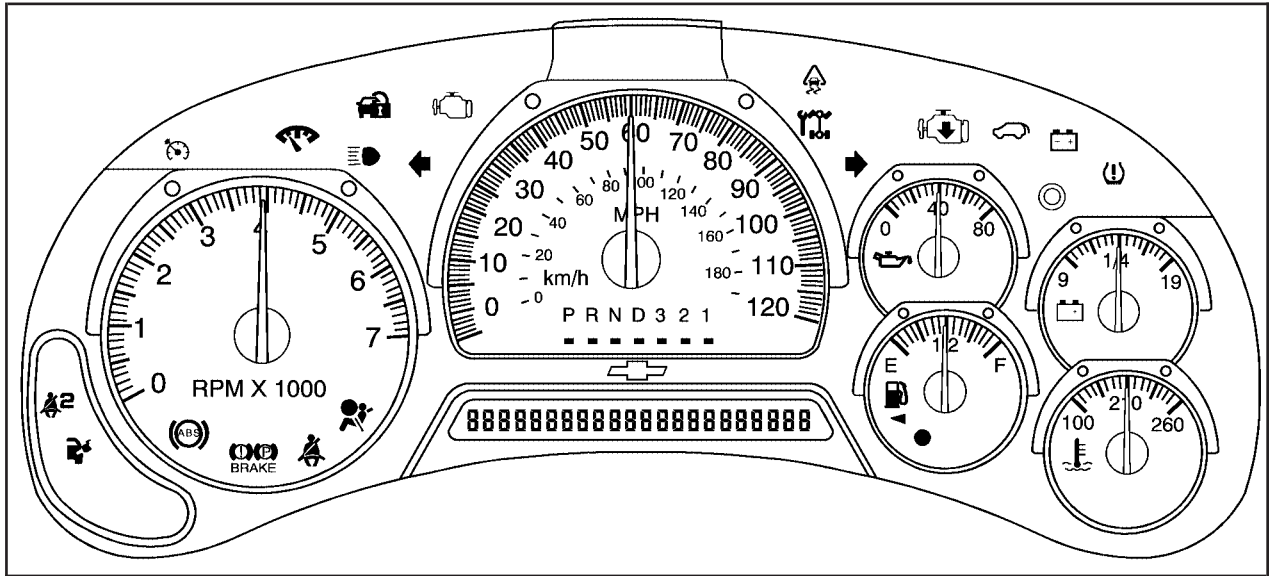

United States Uplevel version shown, Canada, Base and SS Model similar

## Speedometer and Odometer

The speedometer lets you see your speed in both miles per hour (mph) and kilometers per hour (km/h).

The odometer shows how far your vehicle has been driven, in either miles (used in the United States) or kilometers (used in Canada).

The odometer mileage can be checked without the vehicle running. Press the trip stem located on the instrument panel cluster.

If your vehicle needs a new odometer installed, the new one will be set to the correct mileage total of the old odometer.

## Trip Odometer

The trip odometer can tell you how far your vehicle has been driven since you last set the trip odometer to zero.

The odometer works together with the Driver Information Center (DIC). You can set a Trip A and Trip B odometer. See “Trip Information” under *DIC Operation and Displays on page 217*.

The odometer mileage can be checked without the vehicle running. Press the trip stem on the instrument panel cluster.

## Tachometer

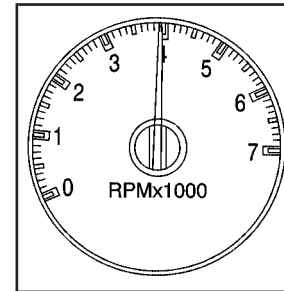

The tachometer displays the engine speed in revolutions per minute (rpm).

## Safety Belt Reminder Light

When the key is turned to RUN or START, a chime will sound for several seconds to remind you buckle your safety belt. The driver safety belt light will also come on and stay on for several seconds, then it will flash for several more. You should buckle your seat belt.



This chime and light will be repeated if the driver remains unbuckled and the vehicle is in motion.

If the driver's belt is buckled, neither the chime nor the light will come on.

## Passenger Safety Belt Reminder Light

Several seconds after the key is turned to RUN or START, a chime will sound for several seconds to remind the front passenger to buckle their safety belt. This would only occur if the passenger airbag is enabled. See *Passenger Sensing System on page 82* for more information. The passenger safety belt light will also come on and stay on for several seconds, then it will flash for several more.



This chime and light will be repeated if the passenger remains unbuckled and the vehicle is in motion.

If the passenger's safety belt is buckled, neither the chime nor the light will come on.

## Airbag Readiness Light

There is an airbag readiness light on the instrument panel, which shows the airbag symbol. The system checks the airbag's electrical system for malfunctions. The light tells you if there is an electrical problem. The system check includes the airbag sensors, the airbag modules, the wiring and the crash sensing and diagnostic module. For more information on the airbag system, see *Airbag System on page 71*.



This light will come on when you start your vehicle, and it will flash for a few seconds.

Then the light should go out. This means the system is ready.

### CAUTION:

**If the airbag readiness light stays on after you start your vehicle, it means the airbag system may not be working properly. The airbags in your vehicle may not inflate in a crash, or they could even inflate without a crash. To help avoid injury to yourself or others, have your vehicle serviced right away if the airbag readiness light stays on after you start your vehicle.**

If the airbag readiness light stays on after you start the vehicle or comes on when you are driving, your airbag system may not work properly. Have your vehicle serviced right away.

The airbag readiness light should flash for a few seconds when you turn the ignition key to RUN. If the light does not come on then, have it fixed so it will be ready to warn you if there is a problem.

## Passenger Airbag Status Indicator

Your vehicle has the passenger sensing system. Your rearview mirror has a passenger airbag status indicator.



United States

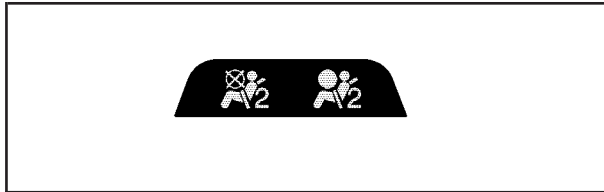

Canada

When the ignition key is turned to RUN or START, the passenger airbag status indicator will light ON and OFF, or the symbol for on and off, for several seconds as a system check. Then, after several more seconds, the status indicator will light either ON or OFF, or either the on or off symbol to let you know the status of the right front passenger's frontal airbag.

If the word ON or the on symbol is lit on the passenger airbag status indicator, it means that the right front passenger's frontal airbag is enabled (may inflate).



 **CAUTION:**

**If the on indicator comes on when you have a rear-facing child restraint installed in the right front passenger's seat, it means that the passenger sensing system has not turned off the passenger's frontal airbag. A child in a rear-facing child restraint can be seriously injured or killed if the right front passenger's airbag inflates. This is because the back of the rear-facing child restraint would be very close to the inflating airbag. Do not use a rear-facing child restraint in the right front passenger's seat if the airbag is turned on.**

If your vehicle has a rear seat that will accommodate a rear-facing child restraint, a label on your sun visor says, "Never put a rear-facing child seat in the front." This is because the risk to the rear-facing child is so great, if the airbag deploys.

 **CAUTION:**

**Even though the passenger sensing system is designed to turn off the passenger's frontal airbag if the system detects a rear-facing child restraint, no system is failsafe, and no one can guarantee that an airbag will not deploy under some unusual circumstance, even though it is turned off. We recommend that rear-facing child restraints be secured in the rear seat, even if the airbag is off.**

If your vehicle does not have a rear seat that will accommodate a rear-facing child restraint, never put a child in a rear-facing child restraint in the right front passenger seat unless the passenger airbag status indicator shows off. Never put a rear-facing child restraint in the right front passenger seat unless the airbag is off.

Here is why:

 **CAUTION:**

Even though the passenger sensing system is designed to turn off the passenger's frontal airbag if the system detects a rear-facing child restraint, no system is fail-safe, and no one can guarantee that an airbag will not deploy under some unusual circumstance, even though it is turned off. We recommend that rear-facing child restraints be transported in vehicles with a rear seat that will accommodate a rear-facing child restraint, whenever possible.

If the word OFF or the off symbol is lit on the airbag status indicator, it means that the passenger sensing system has turned off the right front passenger's frontal airbag. See *Passenger Sensing System on page 82* for more on this, including important safety information.

If, after several seconds, all status indicator lights remain on, or if there are no lights at all, there may be a problem with the lights or the passenger sensing system. See your dealer for service.

 **CAUTION:**

If the off indicator and the airbag readiness light ever come on together, it means that something may be wrong with the airbag system. If this ever happens, have the vehicle serviced promptly, because an adult-size person sitting in the right front passenger seat may not have the protection of the frontal airbag. See *Airbag Readiness Light on page 199*.

## Charging System Light

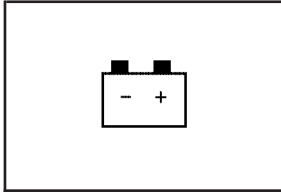

The charging system light will come on briefly when you turn on the ignition, but the engine is not running, as a check to show you it is working.

It should go out once the engine is running. If it stays on, or comes on while you are driving, you may have a problem with the charging system. It could indicate that you have problems with a generator drive belt, or another electrical problem. Have it checked right away. Driving while this light is on could drain your battery.

If you must drive a short distance with the light on, be certain to turn off all your accessories, such as the radio and air conditioner.

## Voltmeter Gage

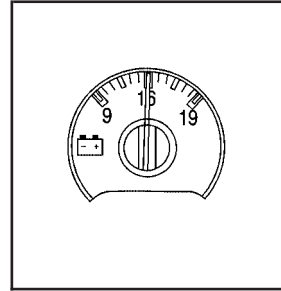

When your engine is not running, but the ignition is in RUN, this gage displays the battery voltage in DC volts.

When the engine is running, the gage shows the condition of the charging system. The gage may transition from a higher to lower or a lower to higher reading. This is normal. Readings between the low and high warning zones indicate the normal operating range. The voltmeter gage may also read lower when in fuel economy mode. This is normal.

Readings in the low warning zone may occur when a large number of electrical accessories are operating in the vehicle and the engine is left idling for an extended period. This condition is normal since the charging system is not able to provide full power at engine idle. As engine speeds are increased, this condition should correct itself as higher engine speeds allow the charging system to create maximum power.

You can only drive for a short time with the reading in either warning zone. If you must drive, turn off all unnecessary accessories.

Readings in either warning zone indicate a possible problem in the electrical system. Have the vehicle serviced as soon as possible.

## Brake System Warning Light

When the ignition is on, the brake system warning light will come on when you set your parking brake. The light will stay on if your parking brake does not release fully. If it stays on after your parking brake is fully released, it means your vehicle has a brake problem. A chime may also sound when the light comes on.

Your vehicle's hydraulic brake system is divided into two parts. If one part is not working, the other part can still work and stop you. For good braking, though, you need both parts working well.

If the warning light comes on, there could be a brake problem. Have your brake system inspected right away.

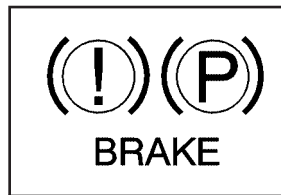

United States

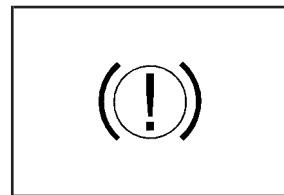

Canada

This light should come on briefly when you turn the ignition key to RUN. If it does not come on then, have it fixed so it will be ready to warn you if there is a problem.

If the light comes on while you are driving, pull off the road and stop carefully. You may notice that the pedal is harder to push or the pedal may go closer to the floor. It may take longer to stop. If the light is still on, have the vehicle towed for service. See *Towing Your Vehicle on page 356*.

 **CAUTION:**

**Your brake system may not be working properly if the brake system warning light is on. Driving with the brake system warning light on can lead to an accident. If the light is still on after you have pulled off the road and stopped carefully, have the vehicle towed for service.**

## Anti-Lock Brake System Warning Light

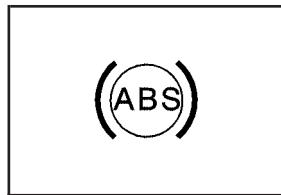

With the Anti-Lock Brake System (ABS), this light will come on when you start your engine and may stay on for several seconds, that is normal.

A chime may also sound when the light comes on.

If the light stays on, or comes on when you are driving, your vehicle needs service. If the regular brake system warning light is not on, you still have brakes, but you do not have anti-lock brakes. If the regular brake system warning light is also on, you do not have anti-lock brakes and there is a problem with your regular brakes. See *Brake System Warning Light on page 204* earlier in this section.

The ABS warning light should come on briefly when you turn the ignition key to RUN. If the light does not come on then, have it fixed so it will be ready to warn you if there is a problem.

## StabiliTrak<sup>®</sup> Service Light



This light will come on briefly when the engine is started.

This light will come on if a problem is detected in the StabiliTrak<sup>®</sup> system.

For more information see *StabiliTrak<sup>®</sup> System on page 307*.

## StabiliTrak<sup>®</sup> Indicator Light



This warning light should come on briefly when the engine is started.

During most driving conditions, this light will not come on. If the StabiliTrak<sup>®</sup> System is actively controlling the stability and/or traction of the vehicle, this light will flash. This is normal.

This light will come on if any portion of the system has been manually turned off or a problem is detected in the system.

If your vehicle has a Driver Information Center, a message will appear also, see *DIC Warnings and Messages on page 220* and *StabiliTrak<sup>®</sup> System on page 307* for more information.

## Engine Coolant Temperature Gage

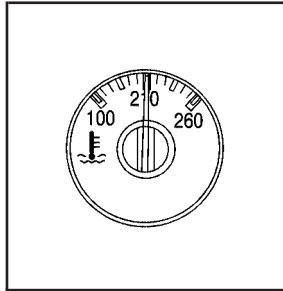

United States

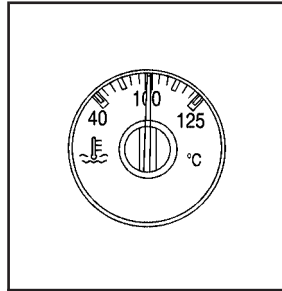

Canada

This gage shows the engine coolant temperature. If the gage pointer moves into the red area, it means that your engine coolant has overheated. If you have been operating your vehicle under normal driving conditions, you should pull off the road, stop your vehicle and turn off the engine as soon as possible.

See *Engine Overheating* on page 414 for more information.

## Tire Pressure Light

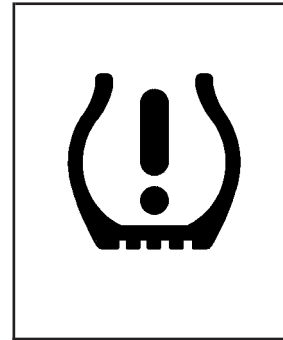

This light will come on briefly when you turn the ignition to RUN.

This light will also come on when one or more of your tires are significantly underinflated.

If your vehicle has a Driver Information Center (DIC), a CHECK TIRE PRESSURE DIC message will accompany the light, see *DIC Warnings and Messages* on page 220.

Stop and check your tires as soon as it is safe to do so. If underinflated, inflate to the proper pressure. See *Tires* on page 443 for more information.

This light will flash for approximately 70 seconds and then turn on solid if a problem is detected with the Tire Pressure Monitor system.

See *Tire Pressure Monitor System* on page 455 for more information.

## Malfunction Indicator Lamp

### Check Engine Light

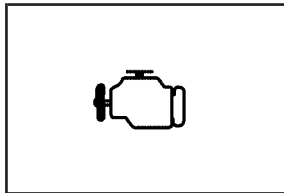

Your vehicle has a computer which monitors operation of the fuel, ignition, and emission control systems.

This system is called OBD II (On-Board Diagnostics-Second Generation) and is intended to assure that emissions are at acceptable levels for the life of the vehicle, helping to produce a cleaner environment. The check engine light comes on to indicate that there is a problem and service is required. Malfunctions often will be indicated by the system before any problem is apparent.

This may prevent more serious damage to your vehicle. This system is also designed to assist your service technician in correctly diagnosing any malfunction.

**Notice:** If you keep driving your vehicle with this light on, after awhile, your emission controls may not work as well, your fuel economy may not be as good, and your engine may not run as smoothly. This could lead to costly repairs that may not be covered by your warranty.

**Notice:** Modifications made to the engine, transmission, exhaust, intake, or fuel system of your vehicle or the replacement of the original tires with other than those of the same Tire Performance Criteria (TPC) can affect your vehicle's emission controls and may cause this light to come on. Modifications to these systems could lead to costly repairs not covered by your warranty. This may also result in a failure to pass a required Emission Inspection/Maintenance test. See *Accessories and Modifications* on page 382.



This light should come on, as a check to show you it is working, when the ignition is on and the engine is not running. If the light does not come on, have it repaired. This light will also come on during a malfunction in one of two ways:

- **Light Flashing** — A misfire condition has been detected. A misfire increases vehicle emissions and may damage the emission control system on your vehicle. Diagnosis and service may be required.
- **Light On Steady** — An emission control system malfunction has been detected on your vehicle. Diagnosis and service may be required.

## If the Light is Flashing

The following may prevent more serious damage to your vehicle:

- Reducing vehicle speed
- Avoiding hard accelerations
- Avoiding steep uphill grades
- If you are towing a trailer, reduce the amount of cargo being hauled as soon as it is possible

If the light stops flashing and remains on steady, see “If the Light Is On Steady” following.

If the light continues to flash, when it is safe to do so, stop the vehicle. Find a safe place to park your vehicle. Turn the key off, wait at least 10 seconds and restart the engine. If the light remains on steady, see “If the Light Is On Steady” following. If the light is still flashing, follow the previous steps, and see your dealer for service as soon as possible.

## If the Light Is On Steady

You may be able to correct the emission system malfunction by considering the following:

Did you recently put fuel into your vehicle?

If so, reinstall the fuel cap, making sure to fully install the cap. See *Filling the Tank on page 387*. The diagnostic system can determine if the fuel cap has been left off or improperly installed. A loose or missing fuel cap will allow fuel to evaporate into the atmosphere. A few driving trips with the cap properly installed should turn the light off.

Did you just drive through a deep puddle of water?

If so, your electrical system may be wet. The condition will usually be corrected when the electrical system dries out. A few driving trips should turn the light off.

Have you recently changed brands of fuel?

If so, be sure to fuel your vehicle with quality fuel. See *Gasoline Octane on page 384*. Poor fuel quality will cause your engine not to run as efficiently as designed. You may notice this as stalling after start-up, stalling when you put the vehicle into gear, misfiring, hesitation on acceleration, or stumbling on acceleration. (These conditions may go away once the engine is warmed up.) This will be detected by the system and cause the light to turn on.

If you experience one or more of these conditions, change the fuel brand you use. It will require at least one full tank of the proper fuel to turn the light off.

If none of the above steps have made the light turn off, your dealer can check the vehicle. Your dealer has the proper test equipment and diagnostic tools to fix any mechanical or electrical problems that may have developed.

## Emissions Inspection and Maintenance Programs

Some state/provincial and local governments have or may begin programs to inspect the emission control equipment on your vehicle. Failure to pass this inspection could prevent you from getting a vehicle registration.

Here are some things you need to know to help your vehicle pass an inspection:

Your vehicle will not pass this inspection if the check engine light is on or not working properly.

Your vehicle will not pass this inspection if the OBD (on-board diagnostic) system determines that critical emission control systems have not been completely diagnosed by the system. The vehicle would be considered not ready for inspection. This can happen if you have recently replaced your battery or if your battery has run down. The diagnostic system is designed to evaluate critical emission control systems during normal driving. This may take several days of routine driving. If you have done this and your vehicle still does not pass the inspection for lack of OBD system readiness, your dealer can prepare the vehicle for inspection.

## Oil Pressure Gage

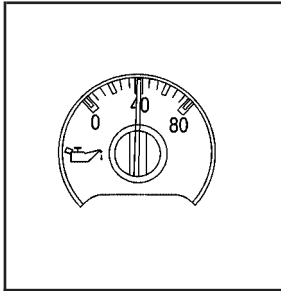

United States

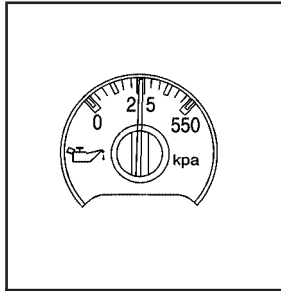

Canada

The oil pressure gage shows the engine oil pressure in psi (pounds per square inch) when the engine is running. Canadian vehicles indicate pressure in kPa (kilopascals).

### CAUTION:

**Do not keep driving if the oil pressure is low. If you do, your engine can become so hot that it catches fire. You or others could be burned. Check your oil as soon as possible and have your vehicle serviced.**

***Notice:*** Lack of proper engine oil maintenance may damage the engine. The repairs would not be covered by your warranty. Always follow the maintenance schedule in this manual for changing engine oil.

Oil pressure may vary with engine speed, outside temperature and oil viscosity, but readings above the low pressure zone indicate the normal operating range.

A reading in the low pressure zone may be caused by a dangerously low oil level or other problems causing low oil pressure.

## Change Engine Oil Light

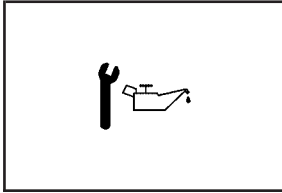

Your vehicle may have a change engine oil light.

When this light comes on it means that an oil change and other maintenance procedures are required for your vehicle.

See *Scheduled Maintenance on page 517* and *Engine Oil on page 398* for more information.

Once the engine oil has been changed, the change engine oil light must be reset. Until it is reset, the light will stay on when the engine is on.

## Security Light

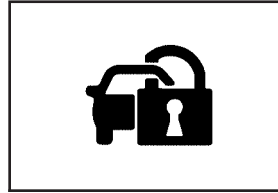

This light will come on briefly when you turn the key toward START.

The light will stay on until the engine starts. If the light flashes, the Passlock<sup>®</sup> system has entered a tamper mode. If the vehicle fails to start, see *Passlock<sup>®</sup> on page 111*.

If the light comes on continuously while driving and stays on, there may be a problem with the Passlock<sup>®</sup> system. Your vehicle will not be protected by Passlock<sup>®</sup>, and you should see your dealer.

Also, see *Content Theft-Deterrent on page 110* for additional information regarding the security light.

## Cruise Control Light

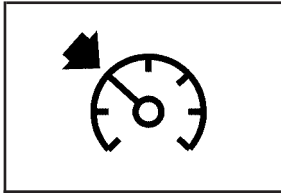

If your vehicle has a Driver Information Center (DIC), this light will come on when the cruise control is set.

See *Cruise Control* on page 174 and *DIC Warnings and Messages* on page 220 for more information.

## Reduced Engine Power Light

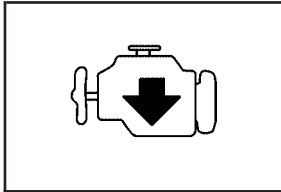

This light comes on when a noticeable reduction in the vehicle's performance occurs.

The vehicle can be driven at a reduced speed when the reduced engine power light is on, but acceleration and speed may be reduced.

The performance may be reduced until the next time you drive your vehicle. If this light stays on, see your dealer as soon as possible for diagnosis and repair.

This light may also come on if there is a problem with the Electronic Throttle Control (ETC) system. If this happens, take the vehicle in for service as soon as possible.

## Highbeam On Light

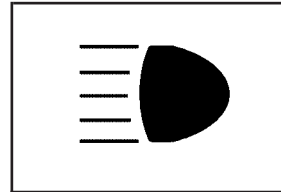

This light comes on when the high-beam headlamps are in use.

See *Headlamp High/Low-Beam Changer* on page 172.

## Service Four-Wheel Drive Warning Light

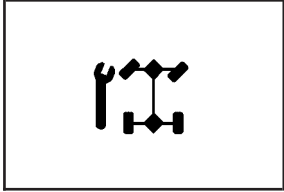

This light should come on briefly when you turn on the ignition, as a check to show you it is working.

The service four-wheel drive light comes on, except for the SS model, to indicate that there may be a problem with the drive system and service is required. Malfunctions can be indicated by the system before any problem is apparent, which may prevent serious damage to the vehicle. This system is also designed to assist your GM dealer in correctly diagnosing a malfunction.

## Check Gages Warning Light

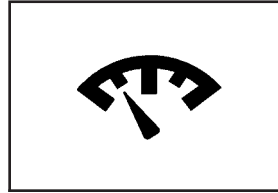

The check gages light will come on briefly when you are starting the engine.

If the light comes on and stays on while you are driving, check your coolant temperature and engine oil pressure gages to see if they are in the warning zones.

## Gate Ajar Light

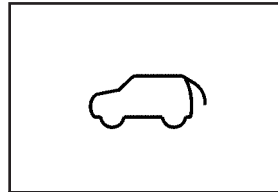

If this light comes on, the liftgate or liftglass is not completely shut.

Close the liftgate or liftglass. Never drive with the liftgate or liftglass even partially open.

## Fuel Gage

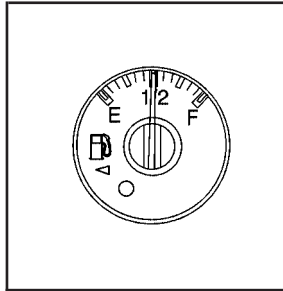

United States

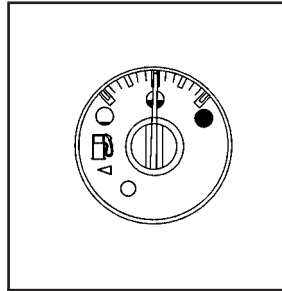

Canada

When the ignition is on, the fuel gage tells you about how much fuel you have remaining.

Here are four things that some owners ask about. None of these show a problem with your fuel gage:

- At the gas station, the gas pump shuts off before the gage reads full.
- It takes a little more or less fuel to fill up than the gage indicated. For example, the gage may have indicated the tank was half full, but it actually took a little more or less than half the tank's capacity to fill the tank.

- The gage moves a little when you turn a corner or speed up.
- The gage doesn't go back to empty when you turn off the ignition.

## Low Fuel Warning Light

The light next to the fuel gage will come on briefly when you are starting the engine.

This light comes on when the fuel tank is low on fuel. To turn it off, add fuel to the fuel tank.

## Check Gas Cap Light

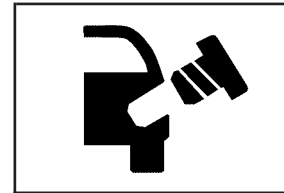

If your vehicle has this light, it will come on if your gas cap is not securely fastened.

See *Malfunction Indicator Lamp* on page 208 for more information.

## Driver Information Center (DIC)

Your vehicle may have this feature. The Driver Information Center (DIC) display is located on the instrument panel cluster, below the speedometer. If your vehicle has DIC buttons, they are located on the steering wheel. The DIC can display information such as the trip odometer, fuel economy, customization features, and warning/status messages.

If your vehicle does not have DIC steering wheel buttons, you will not have all of the features listed. Scroll through the odometer and trip odometer by pressing the trip odometer reset stem located on the instrument panel cluster. Turn off, or acknowledge, DIC messages by pressing the trip odometer reset stem. See *Speedometer and Odometer on page 197* for information on features for vehicles without DIC buttons.

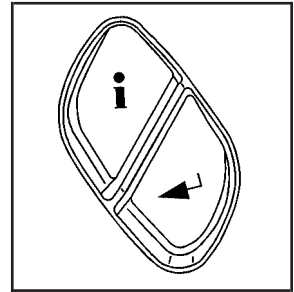
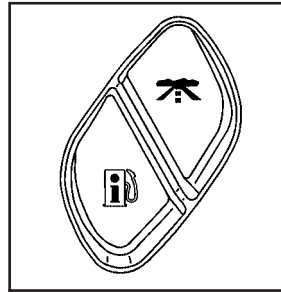

 **(Trip Information):** Press this button to display the odometer, trip odometers, tire pressure for vehicles with a Tire Pressure Monitor (TPM) system, and timer.

 **(Fuel Information):** Press this button to display the current range, fuel used, average fuel economy, and engine oil life.



**i (Customization):** Press this button to access the vehicle settings menu and customize the personal settings on your vehicle.

**↶ (Select):** Press this button to reset certain DIC functions and set your customization settings. Pressing any of the DIC buttons will acknowledge DIC messages and clear them from the DIC display.

## DIC Operation and Displays

The DIC comes on when the ignition is on. After a short delay the DIC will display the information that was last displayed before the engine was turned off.

If a problem is detected, a warning message will appear on the display. Pressing the trip stem will acknowledge any warning or service messages. Pressing any of the DIC steering wheel buttons — trip information, fuel information, customization, or select button — will also acknowledge any warnings or service messages.

You should take any message that appears on the display seriously and remember that clearing the message will only make the message disappear, not correct the problem.

The DIC has different modes which can be accessed by pressing the four DIC buttons located on the steering wheel. These buttons are trip information, fuel information, customization, and select. The button functions are detailed in the following pages.

## Trip Information Button

**⤴ (Trip Information):** Press the trip information button to scroll through the ODOMETER, TRIP A, TRIP B, TIRE PRESSURES, and TIMER.

**Odometer:** Press the trip information button until ODOMETER appears on the display. This mode shows the total distance the vehicle has been driven in either miles or kilometers. Pressing the reset stem located on the instrument cluster with the vehicle off will also display the odometer.

**Trip A:** Press the trip information button until TRIP A appears on the display. This mode shows the current distance traveled since the last reset for TRIP A in either miles or kilometers.

**Trip B:** Press the trip information button until TRIP B appears on the display. This mode shows the current distance traveled since the last reset for TRIP B in either miles or kilometers.

To reset TRIP A or TRIP B information, press and hold the select button for one second while in one of the trip modes. This will reset the information for TRIP A or TRIP B.

You can also reset the TRIP A or TRIP B while they are displayed by pressing the reset stem on the cluster. If you press and hold the reset stem or the select button for more than four seconds, the display will show the distance traveled since the last ignition cycle for TRIP A or TRIP B.

**Tire Pressures:** Press the trip information button until TIRE PRESSURES appears on the display. This mode shows the tire pressure in pounds per square inch (psi) or kilopascals (kPa). Press the select button to scroll through the following information:

- LF TIRE shows the tire pressure for the front driver's side tire.
- RF TIRE shows the tire pressure for the front passenger's side tire.

- LR TIRE shows the tire pressure for the rear driver's side tire.
- RR TIRE shows the tire pressure for the rear passenger's side tire.

**Timer:** The DIC can be used as a timer. Press the select button while TIMER is displayed to start the timer. The display will show the amount of time that has passed since the timer was last reset, not including time the ignition is off. Time will continue to be counted as long as the ignition is on, even if another display is being shown on the DIC. The timer will record up to 99 hours, 59 minutes and 59 seconds (99:59:59) after which the display will roll back to zero.

To stop the counting of time, press the select button briefly while TIMER is displayed.

To reset the timer to zero, press and hold the select button while TIMER is displayed.

## Fuel Information Button

 **(Fuel Information):** Press the fuel information button to scroll through the range, fuel used, average fuel economy, and the engine oil life system.

**Fuel Range:** Press the fuel information button until RANGE appears on the display. This mode shows the remaining distance you can drive without refueling. It is based on fuel economy and the fuel remaining in the fuel tank. The display will show LOW if the fuel level is low.

The fuel economy data used to determine fuel range is an average of recent driving conditions. As your driving conditions change, this data is gradually updated. Fuel range cannot be reset.

**Fuel Used:** Press the fuel information button until FUEL USED appears on the display. This mode shows the number of gallons or liters of fuel used since the last reset of this menu item. To reset the fuel used information, press and hold the select button for one second while FUEL USED is displayed.

**Average Fuel Economy:** Press the fuel information button until AVG. ECON appears on the display. This mode shows how many miles per gallon (MPG), liters per 100 kilometers (L/100 km), or kilometers per liter (km/L) your vehicle is getting based on current and past driving conditions.

Press and hold the select button for one second while AVG. ECON is displayed to reset the average fuel economy. Average fuel economy will then be calculated starting from that point. If the average fuel economy is not reset, it will be continually updated each time you drive.

**Engine Oil Life System:** Press the fuel information button until ENGINE OIL LIFE appears on the display. The engine oil life system shows an estimate of the oil's remaining useful life. It will show 100% when the system is reset after an oil change. It will alert you to change your oil on a schedule consistent with your driving conditions.

Always reset the engine oil life system after an oil change. To reset the engine oil life system, see *Engine Oil Life System on page 404*.

In addition to the engine oil life system monitoring the oil life, additional maintenance is recommended in the Maintenance Schedule in this manual. See *Engine Oil on page 398* and *Scheduled Maintenance on page 517*.

## Customization Button

**i (Customization):** Press the customization button to access the VEHICLE SETTINGS menu and customize the settings to your vehicle. See *DIC Vehicle Customization on page 226* for more information.

## Select Button

**↵ (Select):** Press the select button to reset certain DIC functions, turn off or acknowledge messages on the DIC display, and set your customization settings. For example, this button will allow you to reset the trip odometers, turn off the FUEL LEVEL LOW message, and enables you to scroll through and select the language in which the DIC information will appear.

## DIC Warnings and Messages

Messages are displayed on the DIC to notify the driver that the status of the vehicle has changed and that some action may be needed to correct the condition. Multiple messages may appear one after another.

Some messages may not require immediate action. Press any of the DIC buttons on the steering wheel or the trip odometer reset stem on the instrument panel cluster to acknowledge that you received the messages and to clear them from the display.

Some messages cannot be cleared from the display because they are more urgent. These messages require action before they can be removed from the DIC display. Take any messages that appear on the display seriously and remember that clearing the messages will only make the messages disappear, not correct the problem.

The following are the possible messages that can be displayed and some information about them.

### CHANGE ENGINE OIL

This message displays when the engine oil needs to be changed and service is required for your vehicle. See *Scheduled Maintenance on page 517* and *Engine Oil on page 398* for more information. Also see *Engine Oil Life System on page 404* for information on how to reset the message. This message clears itself after 10 seconds until the next ignition cycle.

## CHECK TIRE PRESSURE

This message displays when the tire pressure in one of the vehicle's tires needs to be checked. Press any of the DIC buttons, or the trip stem, to acknowledge this message and clear it from the DIC display.

If this message appears on the DIC, stop as soon as you can. Have the tire pressures checked and set to those shown on the Tire Loading Information Label. See *Tires on page 443*, *Loading Your Vehicle on page 350*, and *Inflation - Tire Pressure on page 452*. If the tire pressure is low, the low tire pressure warning light comes on. See *Tire Pressure Light on page 207*.

## CHECK WASHER FLUID

This message displays if the washer fluid level is low. Adding washer fluid to the windshield washer fluid reservoir clears this message. See *Windshield Washer Fluid on page 423*. This message clears itself after 10 seconds, or you can press any of the DIC buttons, or the trip stem, to acknowledge this message and clear it from the DIC display.

## CURB VIEW ACTIVATED

This message displays when the passenger outside rearview mirror moves into the curb view position. See *Outside Curb View Assist Mirror on page 144* for more information.

## DRIVER DOOR AJAR

This message displays and a chime sounds if the driver's door is not fully closed. Stop and turn off the vehicle, check the door for obstructions, and close the door again. Check to see if the message still appears on the DIC. Press any of the DIC buttons, or the trip stem, to acknowledge this message and clear it from the DIC display.

## ENGINE COOLANT HOT/ENGINE OVERHEATED

**Notice:** If you drive your vehicle while the engine is overheating, severe engine damage may occur. If an overheat warning appears on the instrument panel cluster and/or DIC, stop the vehicle as soon as possible. Do not increase the engine speed above normal idling speed. See *Engine Overheating on page 414* for more information.

This message displays and a chime sounds if the cooling system temperature gets hot. See *Engine Overheating on page 414* for the proper course of action. This message clears when the coolant temperature drops to a safe operating temperature.

## FUEL LEVEL LOW

This message displays and a chime sounds if the fuel level is low in the vehicle's fuel tank. Refuel as soon as possible. Press any of the DIC buttons, or the trip stem, to acknowledge this message and clear it from the DIC display. See *Low Fuel Warning Light on page 215*, *Filling the Tank on page 387*, and *Fuel on page 384* for more information.

## ICE POSSIBLE

This message may display if the outside temperature reaches a level where ice could form on the roadway. If the temperature rises to a safe level, the message clears. This message clears itself after 10 seconds, or you can press any of the DIC buttons, or the trip stem, to acknowledge this message and clear it from the DIC display.

## KEY FOB # BATTERY LOW

This message displays if a Remote Keyless Entry (RKE) transmitter battery is low. Replace the battery in the transmitter. See "Battery Replacement" under *Remote Keyless Entry (RKE) System Operation on page 98*. Press any of the DIC buttons, or the trip stem, to acknowledge this message and clear it from the DIC display.

## LEFT REAR DOOR AJAR

This message displays and a chime sounds if the driver's side rear door is not fully closed. Stop and turn off the vehicle, check the door for obstructions, and close the door again. Check to see if the message still appears on the DIC. Press any of the DIC buttons, or the trip stem, to acknowledge this message and clear it from the DIC display.

## OIL PRESSURE LOW/STOP ENGINE

**Notice:** If you drive your vehicle while the engine oil pressure is low, severe engine damage may occur. If a low oil pressure warning appears on the Driver Information Center (DIC), stop the vehicle as soon as possible. Do not drive the vehicle until the cause of the low oil pressure is corrected. See *Engine Oil on page 398* for more information.

This message displays if low oil pressure levels occur. Stop the vehicle as soon as safely possible and do not operate it until the cause of the low oil pressure has been corrected. Check the oil as soon as possible and have your vehicle serviced by your dealer. See *Engine Oil on page 398*.

## PASSENGER DOOR AJAR

This message displays and a chime sounds if the passenger's door is not fully closed. Stop and turn off the vehicle, check the door for obstructions, and close the door again. Check to see if the message still appears on the DIC. Press any of the DIC buttons, or the trip stem, to acknowledge this message and clear it from the DIC display.

## REAR ACCESS OPEN

This message displays and a chime sounds if the liftgate or liftglass is open while the ignition is in RUN. Turn off the vehicle and check the liftgate and liftglass. See *Liftgate/Liftglass on page 106*. Restart the vehicle and check for the message on the DIC display. Press any of the DIC buttons, or the trip stem, to acknowledge this message and clear it from the DIC display.

## RIGHT REAR DOOR AJAR

This message displays and a chime sounds if the passenger's side rear door is not fully closed. Stop and turn off the vehicle, check the door for obstructions, and close the door again. Check to see if the message still appears on the DIC. Press any of the DIC buttons, or the trip stem, to acknowledge this message and clear it from the DIC display.

## SERVICE AIR BAG

This message displays if there is a problem with the airbag system. Have your dealer inspect the system for problems. See *Airbag Readiness Light on page 199* and *Airbag System on page 71* for more information. Press any of the DIC buttons, or the trip stem, to acknowledge this message and clear it from the DIC display.

## SERVICE BRAKE SYSTEM

This message displays if a problem occurs with the brake system. If this message appears, stop as soon as possible and turn off the vehicle. Restart the vehicle and check for the message on the DIC display. If the message is still displayed, or appears again when you begin driving, the brake system needs service. See your dealer.

## SERVICE CHARGING SYS (System)

This message displays if there is a problem with the battery charging system. Under certain conditions, the charging system light may also turn on in the instrument panel cluster. See *Charging System Light on page 203*. The battery will not be charging at an optimal rate and the vehicle will lose the ability to enter the fuel economy mode. The vehicle is safe to drive, however you should have the electrical system checked by your dealer. Press any of the DIC buttons, or the trip stem, to acknowledge this message and clear it from the DIC display.

## SERVICE STABILITRAK

If this message displays, it means there may be a problem with the StabiliTrak<sup>®</sup> system. If this message appears, try to reset the system by performing the following: stop; turn off the engine; then start the engine again. If this message still comes on, it means there is a problem. You should see your dealer for service. The vehicle is safe to drive, however, you do not have the benefit of StabiliTrak<sup>®</sup>, so reduce your speed and drive accordingly. Press any of the DIC buttons, or the trip stem, to acknowledge this message and clear it from the DIC display.



## SERVICE TIRE MONITOR

This message displays if a part on the Tire Pressure Monitor (TPM) system is not working properly. If you drive your vehicle while any of the four sensors are missing or inoperable, the warning comes on in about 20 minutes. A sensor would be missing, for example, if you put different wheels on your vehicle without transferring the sensors. If the warning comes on and stays on, there may be a problem with the TPM. See your dealer.

## STABILITRAK ACTIVE

This message displays anytime the StabiliTrak® system activates to maintain vehicle stability. Any combination of engine speed management, brake traction control, and stability control displays this message.

## STABILITRAK NOT READY

This message may display if driving conditions delay StabiliTrak® system initialization. This is normal. Once the system initializes, this message will no longer be displayed on the DIC.

## STABILITRAK OFF

This message displays when you press the StabiliTrak® button for more than five seconds or when stability control has been automatically disabled. The StabiliTrak® button is located on the transmission shift handle. To limit wheel spin and realize the full benefits of the stability enhancement system, you should normally leave StabiliTrak® on. However, you should turn StabiliTrak® off if your vehicle gets stuck in sand, mud, ice, or snow and you want to rock your vehicle to attempt to free it, or if you are driving in extreme off-road conditions and require more wheel spin. See *If Your Vehicle is Stuck in Sand, Mud, Ice, or Snow on page 348*. To turn the StabiliTrak® system back on, press the StabiliTrak® button again.

There are several conditions that can cause this message to appear.

- The message may display if the brake system warning light is on. See *Brake System Warning Light on page 204*.
- The message displays if the vehicle is shifted into 4LO.

The message turns off as soon as the conditions that caused the message to be displayed are no longer present.

## TIGHTEN FUEL CAP

This message may display and a chime may sound if the vehicle's fuel cap is not tightened properly. Fully reinstall the fuel cap. See *Filling the Tank on page 387*. The diagnostic system can determine if the fuel cap has been left off or improperly installed. A loose or missing fuel cap allows fuel to evaporate into the atmosphere. This message remains on until it is acknowledged and cleared from the DIC display by pressing any of the DIC buttons or the trip stem. The DIC message is also cancelled if the ignition is turned off.

The DIC message and the Service Engine Soon light may come on again during a second trip if the fuel cap is still not tightened properly. See *Malfunction Indicator Lamp on page 208* for more information.

## TRACTION CONTROL OFF

This message displays when you momentarily press the StabiliTrak<sup>®</sup> button located on the transmission shift handle. In this mode, stability control and the brake-traction control are functional. Engine speed management will be modified and the driven wheels can spin more freely. For more details on this mode, see *StabiliTrak<sup>®</sup> System on page 307*.

## TURN SIGNAL ON

This message displays and a chime sounds if a turn signal is left on for 3/4 of a mile (1.2 km). Move the turn signal/multifunction lever to the off position. Press any of the DIC buttons, or the trip stem, to acknowledge this message and clear it from the DIC display.

## DIC Vehicle Customization

Your vehicle may have customization capabilities that allow you to program some features to one setting based on your preference. All of the customizable options listed may not be available on your vehicle. Only the options available display on the Driver Information Center (DIC).

The default settings for the customization features were set when your vehicle left the factory, but may have been changed from their default state since then.

To change feature preferences, make sure the ignition is on and the vehicle is in PARK (P). To avoid excessive drain on the battery, it is recommended that the headlamps are turned off.

Press the customization button to scroll through the available customizable options.

After pressing the customization button, VEHICLE SETTINGS momentarily displays before going to a customization option.

## Lock Doors

Press the customization button until LOCK DOORS: IN GEAR appears in the display. To select your preference for automatic locking, press the select button while LOCK DOORS: IN GEAR is displayed on the DIC. Pressing the select button will scroll through the following choices:

**LOCK DOORS: IN GEAR (default):** The doors will lock when the vehicle is shifted out of PARK (P).

**LOCK DOORS: WITH SPEED:** The doors will lock when the vehicle speed is above 8 mph (13 km/h) for three seconds.

Choose one of the available options and press the customization button while it is displayed on the DIC to select it and move on to the next feature. For more information on automatic door locks, see *Programmable Automatic Door Locks on page 102*.

## Unlock Doors

Press the customization button until UNLOCK DOORS: IN PARK appears in the display. To select your preference for automatic unlocking, press the select button while UNLOCK DOORS: IN PARK is displayed on the DIC. Pressing the select button will scroll through the following choices:

**UNLOCK DOORS: IN PARK (default):** All of the doors will unlock when the vehicle is shifted into PARK (P).

**UNLOCK DRIVER: IN PARK:** The driver's door will be unlocked when the vehicle is shifted into PARK (P).

**UNLOCK DOORS: KEY OUT:** All of the doors will unlock when the key is taken out of the ignition.

**UNLOCK DOORS: MANUALLY:** The doors will not be unlocked automatically.

Choose one of the available options and press the customization button while it is displayed on the DIC to select it and move on to the next feature. For more information on automatic door locks, see *Programmable Automatic Door Locks on page 102*.

## Lock Feedback

Press the customization button until LOCK FEEDBACK: BOTH appears in the display. To select your preference for the feedback you receive when locking the vehicle with the Remote Keyless Entry (RKE) transmitter, press the select button while LOCK FEEDBACK: BOTH is displayed on the DIC. Pressing the select button will scroll through the following choices:

**LOCK FEEDBACK: BOTH (default):** The parking lamps will flash each time you press the button with the lock symbol on the RKE transmitter and the horn will chirp the second time you press the lock button.

**LOCK FEEDBACK: OFF:** There will be no feedback when locking the vehicle.

**LOCK FEEDBACK: LAMPS:** The parking lamps will flash each time you press the button with the lock symbol on the RKE transmitter.

**LOCK FEEDBACK: HORN:** The horn will chirp the second time you press the button with the lock symbol on the RKE transmitter.

Choose one of the available options and press the customization button while it is displayed on the DIC to select it and move on to the next feature.

## Unlock Feedback

Press the customization button until UNLOCK FEEDBACK: LAMPS appears in the display. To select your preference for the feedback you will receive when unlocking the vehicle with the Remote Keyless Entry (RKE) transmitter, press the select button while UNLOCK FEEDBACK: LAMPS is displayed on the DIC. Pressing the select button will scroll through the following choices:

**UNLOCK FEEDBACK: LAMPS (default):** The parking lamps will flash each time you press the button with the unlock symbol on the RKE transmitter.

**UNLOCK FEEDBACK: HORN:** The horn will chirp the second time you press the button with the unlock symbol on the RKE transmitter.

**UNLOCK FEEDBACK: BOTH:** The parking lamps will flash each time you press the button with the unlock symbol on the RKE transmitter and the horn will chirp the second time you press the unlock button.

**UNLOCK FEEDBACK: OFF:** There will be no feedback when unlocking the vehicle.

Choose one of the available options and press the customization button while it is displayed on the DIC to select it and move on to the next feature.

## Headlamp Delay

Press the customization button until HEADLAMP DELAY: 10 SEC appears in the display. To select your preference for how long the headlamps will stay on when you turn off the vehicle, press the select button while HEADLAMP DELAY: 10 SEC is displayed on the DIC. Pressing the select button will scroll through the following choices:

- HEADLAMP DELAY: 10 SEC (Seconds) (default)
- HEADLAMP DELAY: 20 SEC
- HEADLAMP DELAY: 40 SEC
- HEADLAMP DELAY: 1 MIN (Minute)
- HEADLAMP DELAY: 2 MIN
- HEADLAMP DELAY: 3 MIN
- HEADLAMP DELAY: OFF

The amount of time you choose will be the amount of time that the headlamps stay on after you turn off the vehicle. If you choose OFF, the headlamps will turn off as soon as you turn off the vehicle.

Choose one of the available options and press the customization button while it is displayed on the DIC to select it and move on to the next feature.

## Perimeter Lights

Press the customization button until PERIMETER LIGHTS: ON appears in the display. To select your preference for perimeter lighting, press the select button while PERIMETER LIGHTS: ON is displayed on the DIC. Pressing the select button will scroll through the following choices:

**PERIMETER LIGHTS: ON (default):** The headlamps and back-up lamps will come on for 40 seconds, if it is dark enough outside, when you unlock the vehicle with the Remote Keyless Entry (RKE) transmitter.

**PERIMETER LIGHTS: OFF:** The perimeter lights will not come on when you unlock the vehicle with the RKE transmitter.

Choose one of the available options and press the customization button while it is displayed on the DIC to select it and move on to the next feature.

## Easy Exit Seat

Press the customization button until EASY EXIT SEAT: OFF appears in the display. To select your preference for seat position exit, press the select button while EASY EXIT SEAT: OFF is displayed on the DIC. Pressing the select button will scroll through the following choices:

**EASY EXIT SEAT: OFF (default):** No seat exit recall will occur.

**EASY EXIT SEAT: ON:** The driver's seat will move to the exit position when the key is removed from the ignition.

Choose one of the available options and press the customization button while it is displayed on the DIC to select it and move on to the next feature. For more information on seat position exit, see "Easy Exit Seat" under *Memory Seat, Mirrors, and Pedals on page 11*.

## Seat Recall

Press the customization button until SEAT RECALL: OFF appears in the display. To select your preference for recall of the driver's memory seat, mirrors, and adjustable pedals, if your vehicle

has this feature, press the select button while SEAT RECALL: OFF is displayed on the DIC. Pressing the select button will scroll through the following choices:

**SEAT RECALL: OFF (default):** The driver's memory seat, mirrors, and adjustable pedals position you saved will only be recalled when the memory button 1 or 2 is pressed.

**SEAT RECALL: AT KEY IN:** The driver's memory seat, mirrors, and adjustable pedals position you saved will be recalled when you put the key in the ignition.

**SEAT RECALL: ON REMOTE:** The driver's memory seat, mirrors, and adjustable pedals position you saved will be recalled when you unlock the vehicle with the Remote Keyless Entry (RKE) transmitter.

Choose one of the available options and press the customization button while it is displayed on the DIC to select it and move on to the next feature. For more information on the memory seat feature, see *Memory Seat, Mirrors, and Pedals on page 11*.

## Curb View

Press the customization button until CURB VIEW: OFF appears in the display. To select your preference for curb view, press the select button while CURB VIEW: OFF is displayed on the DIC. Pressing the select button will scroll through the following choices:

**CURB VIEW: OFF (default):** The passenger's outside mirror will not be tilted down when the vehicle is shifted into REVERSE (R).

**CURB VIEW: PASSENGER:** The passenger's outside mirror will be tilted down when the vehicle is shifted into REVERSE (R).

When the vehicle is placed in PARK (P) or in any forward gear, the mirror will return to the normal driving position, following a short delay.

Choose one of the available options and press the customization button while it is displayed on the DIC to select it and move on to the next feature. For more information on tilt mirror in reverse, see *Outside Curb View Assist Mirror on page 144*.

## Alarm Warning

Press the customization button until ALARM WARNING: BOTH appears in the display. To select your preference for alarm warning, press the select button while ALARM WARNING: BOTH is displayed on the DIC. Pressing the select button will scroll through the following choices:

**ALARM WARNING: BOTH (default):** The headlamps will flash and the horn will chirp when the alarm is active.

**ALARM WARNING: HORN:** The horn will chirp when the alarm is active.

**ALARM WARNING: LAMPS:** The headlamps will flash when the alarm is active.

**ALARM WARNING: OFF:** There will be no alarm warning on activation.

Choose one of the available options and press the customization button while your choice is displayed on the DIC to select it and move on to the next feature. For more information on alarm warning type, see *Content Theft-Deterrent on page 110*.

## Language

Press the customization button until LANGUAGE: ENGLISH appears in the display. To select your preference for display language, press the select button while LANGUAGE: ENGLISH is displayed on the DIC. Pressing the select button will scroll through the following languages:

- ENGLISH (default)
- FRANCAIS (French)
- ESPANOL (Spanish)

Choose one of the available options and press the customization button while it is displayed on the DIC to select it and move on to the next feature.

If you accidentally choose a language that you do not want or understand, press and hold the customization button and the trip information button at the same time. The DIC will begin scrolling through the languages in their particular language. English will be in English, Francais will be in French, and Espanol will be in Spanish. When you see the language that you would like, release both buttons. The DIC will then display the information in the language you chose.

You can also scroll through the different languages by pressing and holding the trip reset stem for four seconds, as long as you are in the odometer mode.



## Units

Press the customization button until UNITS: U.S. (ENGLISH) appears in the display. To select English or metric, press the select button while UNITS: U.S. (ENGLISH) is displayed on the DIC. Pressing the select button will scroll through the following choices:

- UNITS: U.S. (ENGLISH) (default)
- UNITS: METRIC (km/L)
- UNITS: METRIC (L/100 km)

If U.S. (ENGLISH) is chosen, all information will be displayed in English units. For example, distance will be displayed in miles (mi) and fuel

economy in miles per gallon (MPG). If METRIC (km/L) is chosen, all information will be displayed in metric units. For example, distance will be displayed in kilometers (km) and fuel economy in kilometers per liter (km/L). If METRIC (L/100 km) is chosen, all information will be displayed in metric units. For example, distance will be displayed in kilometers (km) and fuel economy in liters per 100 kilometers (L/100 km).

Choose one of the available options and press the customization button while it is displayed on the DIC to select it and exit out of the customizable options.

## Audio System(s)

Determine which radio your vehicle has and then read the pages following to familiarize yourself with its features.

Driving without distraction is a necessity for a safer driving experience. See *Defensive Driving on page 300*. By taking a few moments to read this manual and get familiar with your vehicle's audio system, you can use it with less effort, as well as take advantage of its features. While your vehicle is parked, set up your audio system by presetting your favorite radio stations, setting the tone, and adjusting the speakers. Then, when driving conditions permit, you can tune to your favorite stations using the presets and steering wheel controls if the vehicle has them.

### CAUTION:

**This system provides you with a far greater access to audio stations and song listings. Giving extended attention to entertainment tasks while driving can cause a crash and you or others can be injured or killed. Always keep your eyes on the road and your mind on the drive — avoid engaging in extended searching while driving.**

Keeping your mind on the drive is important for safe driving. Here are some ways in which you can help avoid distraction while driving.

While your vehicle is parked:

- Familiarize yourself with all of its controls.
- Familiarize yourself with its operation.
- Set up your audio system by presetting your favorite radio stations, setting the tone, and adjusting the speakers. Then, when driving conditions permit, you can tune to your favorite radio stations using the presets and steering wheel controls if the vehicle has them.

**Notice:** Before adding any sound equipment to your vehicle, such as an audio system, CD player, CB radio, mobile telephone, or two-way radio, make sure that it can be added by checking with your dealer. Also, check federal rules covering mobile radio and telephone units. If sound equipment can be added, it is very important to do it properly. Added sound equipment may interfere with the operation of your vehicle's engine, radio, or other systems, and even damage them. Your vehicle's systems may interfere with the operation of sound equipment that has been added.

**Notice:** The chime signals related to safety belts, parking brake, and other functions of your vehicle operate through the radio/entertainment system. If that equipment is replaced or additional equipment is added to your vehicle, the chimes may not work. Make sure that replacement or additional equipment is compatible with your vehicle before installing it. See *Accessories and Modifications* on page 382.

Your vehicle has a feature called Retained Accessory Power (RAP). With RAP, the audio system can be played even after the ignition is turned off. See *Retained Accessory Power (RAP)* on page 114 for more information.

## Setting the Time

The radio may have a button marked with an H or HR to represent hours and an M or MN to represent minutes.

Press and hold the hour button until the correct hour appears on the display. AM or PM will appear on the display for morning or evening hours. Press and hold the minute button until the correct minute appears on the display. The time can be set with the ignition on or off.

To synchronize the time with an FM station broadcasting Radio Data System (RDS) information, press and hold the hour and minute buttons at the same time until UPDATED and the clock symbol appear on the display. If the time is not available from the station, NO UPDAT will appear on the display.

RDS time is broadcast once a minute. After tuning to an RDS broadcast station, it may take a few minutes for the time to update.

## Radio with CD (Base)

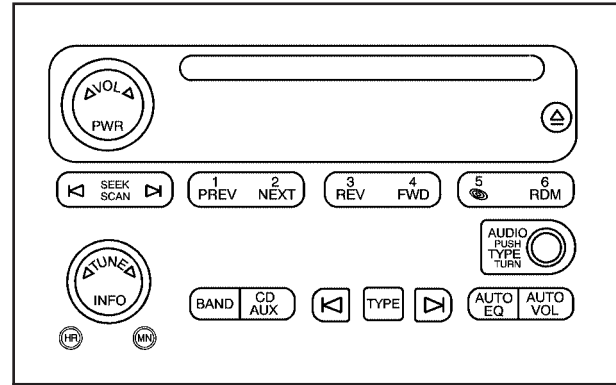

**Base Radio Shown, Bose® Similar**

If your vehicle has the Bose® audio system, your vehicle has six Bose® amplified speakers.

## Radio Data System (RDS)

The audio system has a Radio Data System (RDS). RDS features are available for use only on FM stations that broadcast RDS information.

With RDS, the radio can do the following:

- Seek to stations broadcasting the selected type of programming
- Receive announcements concerning local and national emergencies
- Display messages from radio stations

This system relies upon receiving specific information from these stations and only works when the information is available. In rare cases, a radio station can broadcast incorrect information that causes the radio features to work improperly. If this happens, contact the radio station.

While the radio is tuned to an RDS station, the station name or call letters display instead of the frequency. RDS stations can also provide the time of day, a program type (PTY) for current programming, and the name of the program being broadcast.

## XM™ Satellite Radio Service

XM™ is a satellite radio service that is based in the 48 contiguous United States and Canada. XM™ offers a large variety of coast-to-coast channels including music, news, sports, talk, traffic/weather (U.S. subscribers), and children's programming. XM™ provides digital quality audio and text information that includes song title and artist name. A service fee is required in order to receive the XM™ service. For more information, contact XM™; In the U.S. at [www.xmradio.com](http://www.xmradio.com) or call 1-800-852-XXXM (9696) or in Canada at [www.xmradio.ca](http://www.xmradio.ca) or call 1-877-GET-XMSR (438-9677).

## Playing the Radio

**PWR (Power):** Press this knob to turn the system on and off.

◀ **VOL** ▶ (**Volume**): Turn this knob clockwise or counterclockwise to increase or to decrease the volume.

**INFO (Information):** When the ignition is off, press this knob to display the time.

For RDS, press the INFO knob to change what appears on the display while using RDS. The display options are station name, RDS station frequency, PTY (program type), and the name of the program (if available).

For XM™ (if equipped), press the INFO knob while in XM™ mode to retrieve four different categories of information related to the current song or channel: Artist, Song Title, Category or PTY, Channel Number/Channel Name.

To change the default on the display, press the INFO knob until you see the desired display, then press and hold the knob until a beep sounds. The selected display becomes the default.

**AUTO VOL (Automatic Volume):** With automatic volume, the audio system adjusts automatically to make up for road and wind noise as you drive by increasing the volume as vehicle speed increases.

Set the volume at the desired level. Press this button to select LOW, MEDIUM, or HIGH. AVOL displays. Each higher setting provides more volume compensation at faster vehicle speeds. To turn automatic volume off, press this button until AVOL OFF displays.

## Finding a Station

**BAND:** Press this button to switch between FM1, FM2, AM, or XM1 or XM2 (if equipped). The display shows the selection.

**TUNE:** Turn this knob to select radio stations.

◀ **SEEK** ▶ : Press either the SEEK or the TYPE arrows to go to the next or to the previous station and stay there.

The radio only seeks stations with a strong signal that are in the selected band.

◀ **SCAN** ▶ : Press and hold either the SCAN or the TYPE arrows for two seconds until SCAN displays and a beep sounds. The radio goes to a station, plays for a few seconds, then goes to the next station. Press either the SCAN or the TYPE arrows again to stop scanning.

To scan preset stations, press and hold either the SCAN or the TYPE arrows for more than four seconds. PSCN displays and a double beep sounds. The radio goes to a preset station, plays for a few seconds, then goes to the next preset station. Press either the SCAN or the TYPE arrows again to stop scanning presets.

The radio only scans stations with a strong signal that are in the selected band.

## Setting Preset Stations

Up to 30 stations (six FM1, six FM2, and six AM, six XM1 and six XM2 (if equipped), can be programed on the six numbered pushbuttons, by performing the following steps:

1. Turn the radio on.
2. Press BAND to select FM1, FM2, AM, or XM1 or XM2.
3. Tune in the desired station.
4. Press and hold one of the six numbered pushbuttons until a beep sounds. When that numbered pushbutton is pressed, the station that was set, returns.
5. Repeat the Steps 2 through 4 for each pushbutton.

To store an equalization setting to a preset station perform the following:

1. Tune to the preset station.
2. Press and release the AUTO EQ button to select the equalization setting.

Once the equalization no longer displays, the equalization is set for that preset station.

## Setting the Tone (Bass/Midrange/Treble)

**AUDIO:** Push and release the AUDIO knob until BASS, MID (midrange) (without Bose®), or TREB (treble) displays. Turn the knob to increase or to decrease the tone. The display shows the bass, midrange (without Bose®), or treble level. If a station is weak or has static, decrease the treble.

To adjust the bass, midrange (without Bose®), or treble to the middle position while it is displayed, push and hold the AUDIO knob. The radio produces one beep and adjusts the display level to the middle position.

To adjust all tone and speaker controls to the middle position, push and hold the AUDIO knob when no tone or speaker control is displayed. ALL CENTERED displays, a beep sounds, and the display level adjusts to the middle position.

**AUTO EQ (Automatic Equalization):** Press this button to select customized equalization settings designed for country/western, jazz, talk, pop, rock, and classical. Selecting CUSTOM or adjusting the tone controls, returns the EQ to the manual mode.

The radio saves separate AUTO EQ settings for each preset and source.

If the radio has the Bose® audio system, the AUTO EQ settings are either CUSTOM or TALK.

## Adjusting the Speakers (Balance/Fade)

**AUDIO:** To adjust the balance between the right and the left speakers, push and release the AUDIO knob until BAL (balance) displays. Turn the knob to move the sound toward the right or the left speakers.

To adjust the fade between the front and the rear speakers, push and release the AUDIO knob until FADE displays. Turn the knob to move the sound toward the front or the rear speakers.

To adjust the balance or fade to the middle position while it is displayed, push the AUDIO knob and hold it until the radio produces one beep. The balance or fade adjusts to the middle position.

To adjust all tone and speaker controls to the middle position, push and hold the AUDIO knob when no tone or speaker control displays. ALL CENTERED displays, a beep sounds, and the display level adjusts to the middle position.

## Finding a Program Type (PTY) Station (RDS and XM™)

To select and find a desired PTY perform the following:

1. Press the TYPE button to activate program type select mode. TYPE and a PTY displays.
2. Turn the TYPE knob or press and release the TYPE button to select a PTY.
3. Once the desired PTY is displayed, press and release either the TYPE or the SEEK arrows to select and to take you to the PTY's first station.
4. To go to another station within that PTY, press the TYPE button then, press either the TYPE or the SEEK arrows once.
5. Press either the TYPE or the SEEK arrows twice to exit program type select mode.

If the radio cannot find the desired program type, NONE displays and the radio returns to the last station you were listening to.



**SCAN:** Scan the stations within a PTY by performing the following:

1. Press the TYPE button to activate program type select mode. TYPE and the last selected PTY displays.
2. Turn the TYPE knob or press and release the TYPE button to select a PTY.
3. Once the desired PTY is displayed, press and hold either the TYPE or the SCAN arrows for two seconds, and the radio begins to scan the stations in the PTY.
4. Press either the TYPE or the SCAN arrows to stop scanning.

**BAND (Alternate Frequency):** Alternate frequency lets the radio switch to a stronger station with the same program type. To turn alternate frequency on, press and hold BAND for two seconds. AF ON displays. The radio can switch to stations with a stronger frequency.

To turn alternate frequency off, press and hold BAND again for two seconds. AF OFF displays. The radio does not switch to other stations.

This function does not apply for XM™ Satellite Radio Service.

## Setting Preset PTYs (RDS Only)

These buttons have factory PTY presets. Up to 12 PTYs (six FM1 and six FM2), can be programmed on the six numbered pushbuttons, by performing the following steps:

1. Press BAND to select FM1 or FM2.
2. Press the TYPE button to activate program type select mode. TYPE and the last selected PTY displays.
3. Turn the TYPE knob or press and release the TYPE button to select a PTY.
4. Press and hold one of the six numbered pushbuttons until a beep sounds. When that numbered pushbutton is pressed (while in program type mode), the PTY that was set, returns.
5. Repeat the steps for each pushbutton.

## RDS Messages

**INFO (Information):** If the current station has a message, the information symbol displays. Press this button to see the message. The message can display the artist, song title, call in phone numbers, etc.

If the entire message is not displayed, parts of the message appears every three seconds. To scroll through the message, press and release the INFO button. A new group of words displays after every press of the button. Once the complete message displays, the information symbol disappears from the display until another new message is received. The last message can be displayed by pressing the INFO button. The last message can be viewed until a new message is received or you can tune to a different station.

## Radio Messages

**CAL ERR (Calibration Error):** The audio system has been calibrated for your vehicle from the factory. If CAL ERR displays, it means that the radio has not been configured properly for the vehicle and must be returned to your dealer for service.

**LOCKED:** This message is displayed when the THEFTLOCK® system has locked up. Take the vehicle to your dealer for service.

If any error occurs repeatedly, or if an error cannot be corrected, contact your dealer.

## Radio Messages for XM™ Only

See *XM Radio Messages on page 274* later in this section for further detail.

## Playing a CD

Insert a CD partway into the slot, label side up. The player pulls it in and the CD should begin playing. If you want to insert a CD with the ignition off, first press the eject button or the INFO knob.

If the ignition or radio is turned off with the CD in the player, it stays in the player. When the ignition or radio is turned on, the CD starts playing where it stopped, if it was the last selected audio source.

When a CD is inserted, the CD symbol displays. As each new track starts to play, the track number displays.

The CD player can play the smaller 3 inch (8 cm) single CDs with an adapter ring. Full-size CDs and the smaller CDs are loaded in the same manner.

If playing a CD-R, the sound quality may be reduced due to CD-R quality, the method of recording, the quality of the music that has been recorded, and the way the CD-R has been handled. There may be an increase in skipping, difficulty in finding tracks, and/or difficulty in loading and ejecting. If these problems occur, check the bottom surface of the CD. If the surface of the CD is damaged, such as cracked, broken, or scratched, the CD will not play properly. If the surface of the CD is soiled, see *Care of Your CDs and DVDs on page 296* for more information.

If there is no apparent damage, try a known good CD.

Do not add any label to a CD, it could get caught in the CD player. If a CD is recorded on a personal computer and a description label is needed, try labeling the top of the recorded CD with a marking pen.

**Notice:** If you add any label to a CD, insert more than one CD into the slot at a time, or attempt to play scratched or damaged CDs, you could damage the CD player. When using the CD player, use only CDs in good condition without any label, load one CD at a time, and keep the CD player and the loading slot free of foreign materials, liquids, and debris.

If an error appears on the display, see “CD Messages” later in this section.

**1 PREV (Previous):** Press this pushbutton to go to the beginning of the current track (if more than eight seconds have played), or to the beginning of the previous track (if less than eight seconds have played). TRACK and the track number displays. If this pushbutton is held or pressed more than once, the player continues moving backward through the CD.

**2 NEXT:** Press this pushbutton to go to the next track. TRACK and the track number displays. If this pushbutton is held or pressed more than once, the player continues moving forward through the CD.

**3 REV (Reverse):** Press and hold this pushbutton to quickly reverse within a track. Press and hold this pushbutton for less than two seconds to reverse at six times the normal playing speed. Press and hold it for more than two seconds to reverse at 17 times the normal playing speed. ET and the elapsed time of the track displays. Release this pushbutton to play the passage.

**4 FWD (Forward):** Press and hold this pushbutton to quickly advance within a track. Press and hold this pushbutton for less than two seconds to advance at six times the normal playing speed. Press and hold it for more than two seconds to advance at 17 times the normal playing speed. ET and the elapsed time of the track displays. Release this pushbutton to play the passage.

**6 RDM (Random):** Press this pushbutton to hear the tracks in random, rather than sequential, order. RDM ON displays. RDM T and the track number displays when each track starts to play. Press this pushbutton again to turn off random play. RDM OFF displays.

**◀ SEEK ▶ :** Press the left arrow to go to the start of the current or to the previous track. Press the right arrow to go to the start of the next track. If either arrow is pressed more than once, the player continues moving backward or forward through the CD.

**◀ SCAN ▶ :** Press and hold either the SCAN or the TYPE arrows for more than two seconds until SCAN displays and a beep sounds. The radio goes to the next track, plays for 10 seconds, then goes to the next track. Press either the SCAN or the TYPE arrows again, to stop scanning.

**INFO (Information):** Press this knob to see how long the current track has been playing. ET and the elapsed time displays. To change the default on the display, track, or elapsed time, press the knob until you see the desired display, then press and hold the knob for two seconds. The radio produces one beep and the selected display becomes the default.

**BAND:** Press this button to listen to the radio while a CD is playing. The inactive CD remains inside the radio for future listening.

**CD AUX (Auxiliary):** Press this button to play a CD while listening to the radio, or to listen to an auxiliary source (such as rear seat entertainment, if equipped).

**△ (Eject):** Press this button to eject a CD. Eject can be activated with either the ignition or radio off. CDs can be loaded with the radio and ignition off if this button is pressed first.

## CD Messages

If the CD comes out, it could be for one of the following reasons:

- It is very hot. When the temperature returns to normal, the CD should play.
- You are driving on a very rough road. When the road becomes smoother, the CD should play.

- The CD is dirty, scratched, wet, or upside down.
- The air is very humid. If so, wait about an hour and try again.
- There could have been a problem while burning the CD.
- The label could be caught in the CD player.

If the CD is not playing correctly, for any other reason, try a known good CD.

If any error occurs repeatedly or if an error cannot be corrected, contact your dealer. If the radio displays an error message, write it down and provide it to your dealer when reporting the problem.

## Radio with CD (MP3)

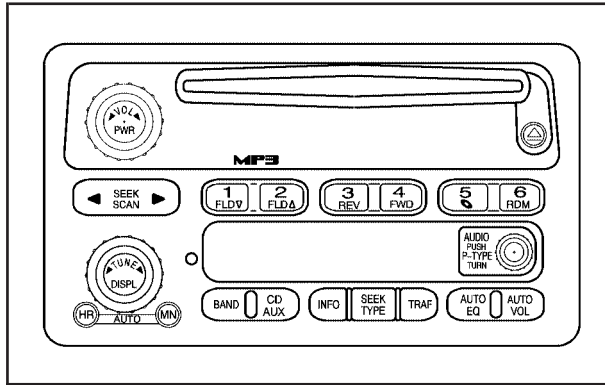

**Base Radio Shown, Bose® Similar**

If your vehicle has the Bose® audio system, your vehicle has six Bose® amplified speakers.

## Radio Data System (RDS)

The audio system has a Radio Data System (RDS). RDS features are available for use only on FM stations that broadcast RDS information.

With RDS, the radio can do the following:

- Seek to stations broadcasting the selected type of programming
- Receive announcements concerning local and national emergencies
- Display messages from radio stations
- Seek to stations with traffic announcements

This system relies upon receiving specific information from these stations and only works when the information is available. In rare cases, a radio station can broadcast incorrect information that causes the radio features to work improperly. If this happens, contact the radio station.

While the radio is tuned to an RDS station, the station name or call letters display instead of the frequency. RDS stations may also provide the time of day, a program type (PTY) for current programming, and the name of the program being broadcast.

## XM™ Satellite Radio Service

XM™ is a satellite radio service that is based in the 48 contiguous United States and Canada. XM™ offers a large variety of coast-to-coast channels including music, news, sports, talk, traffic/weather (U.S. subscribers), and children's programming. XM™ provides digital quality audio and text information that includes song title and artist name. A service fee is required in order to receive the XM™ service. For more information, contact XM™; In the U.S. at [www.xmradio.com](http://www.xmradio.com) or call 1-800-852-XM™ (9696) or in Canada at [www.xmradio.ca](http://www.xmradio.ca) or call 1-877-GET-XMSR (438-9677).

## Playing the Radio

**PWR (Power):** Press this knob to turn the system on and off.

◀ **VOL** ▶ (**Volume**): Turn this knob clockwise or counterclockwise to increase or to decrease the volume.

**DISPL (Display):** When the ignition is turned off, press this knob to display the time.

For RDS, press the DISPL knob to change the display while using RDS. The display options are station name, RDS station frequency, PTY, and the name of the program (if available).

For XM™ (if equipped), press the DISPL knob while in XM™ mode to retrieve four different categories of information related to the current song or channel: Artist, Song Title, Category or PTY, Channel Number/Channel Name.

To change the default on the display, press the DISPL knob until you see the desired display, then press and hold this knob for two seconds. The radio produces one beep and the selected display becomes the default.

**AUTO VOL (Automatic Volume):** With automatic volume, the audio system adjusts automatically to make up for road and wind noise as you drive.

Set the volume at the desired level. Press this button to select LOW, MEDIUM, or HIGH. AVOL displays. Each higher setting allows for more volume compensation at faster vehicle speeds. Then as you drive, automatic volume increases the volume, as necessary, to overcome noise at any speed. The volume level should always sound the same to you as you drive. NONE displays if the radio cannot determine the vehicle speed. To turn automatic volume off, press this button until OFF displays.

## Finding a Station

**BAND:** Press this button to switch between FM1, FM2, AM, or XM1 or XM2 (if equipped). The display shows the selection.

◁ **TUNE** ▷ : Turn this knob to select radio stations.

◁ **SEEK** ▷ : Press the right or the left arrow to go to the next or to the previous station and stay there.

The radio only seeks stations with a strong signal that are in the selected band.

◁ **SCAN** ▷ : Press and hold either arrow for more than two seconds. SCAN displays and the radio produces one beep. The radio goes to a station, plays for a few seconds, then goes to the next station. Press either arrow again or one of the pushbuttons to stop scanning presets.

To scan preset stations, press and hold either arrow for more than four seconds. PSCN displays and the radio produces two beeps. The radio goes to a preset station, plays for a few seconds, then goes to the next preset station. Press either arrow again or one of the pushbuttons to stop scanning presets.

The radio only scans stations with a strong signal that are in the selected band.



## Setting Preset Stations

Up to 30 stations (six FM1, six FM2, and six AM, six XM1 and six XM2 (if equipped)), can be programmed on the six numbered pushbuttons, by performing the following steps:

1. Turn the radio on.
2. Press BAND to select FM1, FM2, AM, or XM1 or XM2.
3. Tune in the desired station.
4. Press AUTO EQ to select the equalization.
5. Press and hold one of the six numbered pushbuttons until a beep sounds. When that numbered pushbutton is pressed, the station that was set, returns and the equalization that was selected is stored for that pushbutton.
6. Repeat the steps for each pushbutton.

## Setting the Tone (Bass/Midrange/Treble)

**AUDIO:** Push and release the AUDIO knob until BASS, MID (midrange) (without Bose®), or TREB (treble) displays. Turn the knob to increase or to decrease the tone. The display shows the bass, midrange (without Bose®), or the treble level. If a station is weak or has static, decrease the treble.

To adjust the bass, midrange (without Bose®), or the treble to the middle position while it is displayed, push and hold the AUDIO knob. The radio produces one beep.

To adjust all tone and speaker controls to the middle position, push and hold the AUDIO knob while no tone or speaker control is displayed. ALL CENTERED displays and a beep sounds.

**AUTO EQ (Automatic Equalization):** Press this button to select customized equalization settings designed for country/western, jazz, talk, pop, rock, and classical.

To return the bass and treble to the manual mode, push and release the AUTO EQ button until CUSTOM displays.

If the radio has the Bose audio system, the equalization settings are either CUSTOM or TALK.

## Adjusting the Speakers (Balance/Fade)

**AUDIO:** To adjust the balance between the right and the left speakers, push and release the AUDIO knob until BAL (balance) displays. Turn the knob to move the sound toward the right or the left speakers.

To adjust the fade between the front and the rear speakers, push and release the AUDIO knob until FADE displays. Turn the knob to move the sound toward the front or the rear speakers.

To adjust the balance or the fade to the middle position while it is displayed, push the AUDIO knob, then push it again and hold it until you hear one beep.

To adjust all tone and speaker controls to the middle position, push and hold the AUDIO knob when no tone or speaker control displays. ALL CENTERED displays and a beep sounds.

## Finding a Program Type (PTY) Station (RDS and XM™)

To select and find a desired PTY perform the following:

1. Turn the P-TYPE knob to select a PTY.
2. Once the desired PTY displays, press the SEEK TYPE button to select and go to the PTY's first station.
3. To go to another station within that PTY, press the SEEK TYPE button twice to display the PTY and then to go to another station.
4. Press the P-TYPE knob to exit program type select mode.

IF PTY times out and no longer displays, go back to Step 1.

If both PTY and TRAF are on, the radio searches for stations with the selected PTY and traffic announcements.

If the radio cannot find the desired program type, NONE displays and the radio returns to the last station you were listening to.

**BAND (AF – Alternate Frequency):** Alternate frequency lets the radio switch to a stronger station with the same program type. To turn alternate frequency on, press and hold BAND for two seconds. A ON displays. The radio can switch to stations with a stronger frequency.

To turn alternate frequency off, press and hold BAND again for two seconds. AF OFF displays. The radio does not switch to other stations.

This function does not apply for XM™ Satellite Radio Service.

## RDS Messages

**ALERT!:** Alert warns of local or national emergencies. When an alert announcement comes on the current radio station, ALERT! displays. You will hear the announcement, even if the volume is low or a CD is playing. If a CD is playing, play stops during the announcement. Alert announcements cannot be turned off.

ALERT! is not affected by tests of the emergency broadcast system. This feature is not supported by all RDS stations.

**INFO (Information):** If the current station has a message, the information symbol displays. Press this button to see the message. The message can display the artist, song title, call in phone numbers, etc.

If the entire message is not displayed, parts of the message appears every three seconds. To scroll through the message, press and release the INFO button. A new group of words display after every press of this button. Once the complete message has displayed, the information symbol disappears from the display until another new message is received. The last message can be displayed by pressing the INFO button. The last message can be viewed until a new message is received or you tune to a different station.

When a message is not available from a station, No Info displays.

**TRAF (Traffic):** If TRAF displays, the tuned station broadcasts traffic announcements and you will hear a traffic announcement when the tuned radio station broadcasts one.

If the station does not broadcast traffic announcements, press the TRAF button and the radio seeks to a station that does. When a station that broadcasts traffic announcements is found, the radio stops seeking and TRAF displays. If no station is found that broadcasts traffic announcements, No Traf displays.

If TRAF displays, press the TRAF button to turn off the traffic announcements.

The radio plays the traffic announcement if the volume is low. The radio interrupts the play of a CD if the last tuned station broadcasts traffic announcements.

This function does not apply to XM™ Satellite Radio Service.

## Radio Messages

**CAL ERR (Calibration Error):** The audio system has been calibrated for your vehicle from the factory. If CAL ERR displays it means that the radio has not been configured properly for your vehicle and it must be returned to your dealer for service.

**LOCKED:** This message is displayed when the THEFTLOCK® system has locked up. Take your vehicle to your dealer for service.

If any error occurs repeatedly or if an error cannot be corrected, contact your dealer.

## Radio Messages for XM™ Only

See *XM Radio Messages on page 274* later in this section for further detail.

## Playing a CD

Insert a CD partway into the slot, label side up. The player pulls it in, and READING displays. The CD should begin playing. If you want to insert a CD with the ignition off, first press the eject button or the DISPL knob.

If the ignition or radio is turned off with a CD in the player it stays in the player. When the ignition or radio is turned on, the CD starts to play where it stopped, if it was the last selected audio source.

When the CD is inserted, the CD symbol displays. As each new track starts to play, the track number also displays.

The CD player can play the smaller 3 inch (8 cm) single CDs with an adapter ring. Full-size CDs and the smaller CDs are loaded in the same manner.

If playing a CD-R, the sound quality can be reduced due to CD-R quality, the method of recording, the quality of the music that has been recorded, and the way the CD-R has been handled. There can be an increase in skipping, difficulty in finding tracks, and/or difficulty in loading and ejecting. If these problems occur, check the bottom surface of the CD. If the surface of the CD is damaged, such as cracked, broken, or scratched, the CD will not play properly. If the surface of the CD is soiled, see *Care of Your CDs and DVDs on page 296* for more information.

If there is no apparent damage, try a known good CD.

Do not add any label to a CD, it could get caught in the CD player. If a CD is recorded on a personal computer and a description label is needed, try labeling the top of the recorded CD with a marking pen.

**Notice:** If you add any label to a CD, insert more than one CD into the slot at a time, or attempt to play scratched or damaged CDs, you could damage the CD player. When using the CD player, use only CDs in good condition without any label, load one CD at a time, and keep the CD player and the loading slot free of foreign materials, liquids, and debris.

If an error appears on the display, see “CD Messages” later in this section.

**1 FLD ▽ (Previous):** This pushbutton does not work while using a non-MP3 CD.

**2 FLD △ (Next):** This pushbutton does not work while using a non-MP3 CD.

**3 REV (Reverse):** Press and hold this pushbutton to reverse quickly within a track. Press and hold this pushbutton for less than two seconds to reverse at 10 times the normal playing speed. Press and hold it for more than two seconds to reverse at 20 times the normal playing speed. Release this pushbutton to play the passage. ET and the elapsed time of the track displays.

**4 FWD (Forward):** Press and hold this pushbutton to advance quickly within a track. Press and hold this pushbutton for less than two seconds to advance at six times the normal playing speed. Press and hold it for more than two seconds to advance at 17 times the normal playing speed. Release this pushbutton to play the passage. ET and the elapsed time of the track displays.

**6 RDM (Random):** Press this pushbutton to hear the tracks in random, rather than sequential, order. RDM ON displays. RDM and the track number displays when each track starts to play. Press RDM again to turn off random play. RDM OFF displays.

◀ **SEEK** ▶ : Press the left arrow to go to the start of the current or the previous track. Press the right arrow to go to the start of the next track. Pressing either arrow for more than two seconds scans the previous or next tracks at five to eight seconds per track. SCAN and the track number displays. Press either arrow to stop scanning.

◀ **TUNE** ▶ : Turning the TUNE knob fast tracks reverse or advances through tracks. The track number displays for each track.

**DISPL (Display):** Press this knob to see how long the current track has been playing. ET and the elapsed time of the track displays. To change the default on the display, track or elapsed time, press this knob until you see the desired display, then press and hold the knob for two seconds. The radio produces one beep and the selected display becomes the default.

**BAND:** Press this button to listen to the radio while a CD is playing. The inactive CD remains inside the radio for future listening.

**CD AUX (Auxiliary):** Press this button to play a CD while listening to the radio. The CD symbol displays when a CD is loaded.

⏏ (**Eject**): Press this button to eject a CD. Eject may be activated with either the ignition or radio off. CDs can be loaded with the ignition and radio off if this button is pressed first.

## Playing an MP3 CD-R Disc

Your vehicle's radio system may have the MP3 feature. If it has this feature, it is capable of playing an MP3 CD-R disc. For more information on how to play an MP3 CD-R disc, see *Using an MP3 on page 268* later in this section.

## CD Messages

**CHECK CD:** If this message appears on the display and/or the CD ejects, it could be for one of the following reasons:

- It is very hot. When the temperature returns to normal, the CD should play.
- You are driving on a very rough road. When the road becomes smoother, the CD should play.
- The CD is dirty, scratched, wet, or upside down.
- The air is very humid. If so, wait about an hour and try again.
- The format of the CD is not compatible. See *Using an MP3 on page 268* later in this section.
- There could have been a problem while burning the CD.
- The label could be caught in the CD player.

If the CD is not playing correctly, for any other reason, try a known good CD.

If any error occurs repeatedly or if an error cannot be corrected, contact your dealer. If the radio displays an error message, write it down and provide it to your dealer when reporting the problem.

## Radio with Six-Disc CD

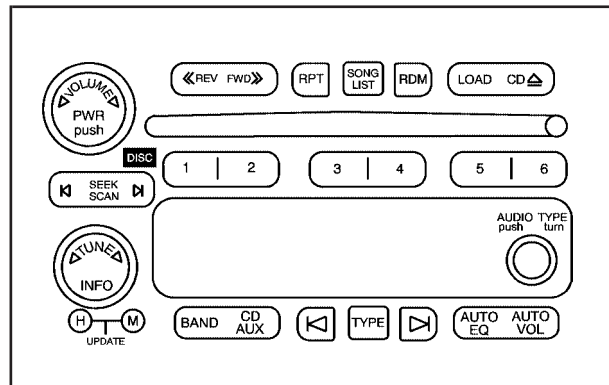

**Base Radio Shown, Bose® Similar**

If your vehicle has the Bose® audio system, your vehicle has six Bose® amplified speakers.

## Radio Data System (RDS)

The audio system has a Radio Data System (RDS). RDS features are available for use only on FM stations that broadcast RDS information.

With RDS, the radio can do the following:

- Seek to stations broadcasting the selected type of programming
- Receive announcements concerning local and national emergencies
- Display messages from radio stations

This system relies upon receiving specific information from these stations and only works when the information is available. In rare cases, a radio station can broadcast incorrect information that causes the radio features to work improperly. If this happens, contact the radio station.

While the radio is tuned to an RDS station, the station name or call letters display instead of the frequency. RDS stations may also provide the time of day, a program type (PTY) for current programming, and the name of the program being broadcast.

## XM™ Satellite Radio Service

XM™ is a satellite radio service that is based in the 48 contiguous United States and Canada. XM™ offers a large variety of coast-to-coast channels including music, news, sports, talk, traffic/weather (U.S. subscribers), and children's programming. XM™ provides digital quality audio and text information that includes song title and artist name. A service fee is required in order to receive the XM™ service. For more information, contact XM™; In the U.S. at [www.xmradio.com](http://www.xmradio.com) or call 1-800-852-XXXM (9696) or in Canada at [www.xmradio.ca](http://www.xmradio.ca) or call 1-877-GET-XMSR (438-9677).

## Playing the Radio

**PWR (Power):** Push this knob to turn the system on and off.

◁ **VOLUME** ▷ : Turn this knob clockwise or counterclockwise to increase or to decrease the volume.

**INFO (Information):** When the ignition is off, press this knob to display the time.



For RDS, press the INFO knob to change what appears on the display while using RDS. The display options are station name, RDS station frequency, PTY, and the name of the program (if available).

For XM™ (if equipped), press the INFO knob while in XM™ mode to retrieve four different categories of information related to the current song or channel: Artist, Song Title, Category or PTY, Channel Number/Channel Name.

To change the default on the display, press the INFO knob until you see the desired display, then hold the knob until a beep sounds. The selected display becomes the default.

**AUTO VOL (Automatic Volume):** With automatic volume, the audio system adjusts automatically to make up for road and wind noise as you drive by increasing the volume as vehicle speed increases.

Set the volume at the desired level. Press this button to select MIN (minimum), MED (medium), or MAX (maximum). AUTO VOL displays. Each higher setting provides more volume compensation at faster vehicle speeds. To turn automatic volume off, press this button until AUTO VOL OFF displays.

## Finding a Station

**BAND:** Press this button to switch between FM1, FM2, AM, or XM1 or XM2 (if equipped). The display shows the selection.

◀ **TUNE** ▶ : Turn this knob to select radio stations.

◀ **SEEK** ▶ : Press either the SEEK or the TYPE arrows to go to the next or to the previous station and stay there.

The radio only seeks stations with a strong signal that are in the selected band.

◀ **SCAN** ▶ : Press and hold either the SCAN or the TYPE arrows for two seconds until SCN displays and a beep sounds. The radio goes to a station, plays for a few seconds, then goes to the next station. Press either the SCAN or the TYPE arrows again to stop scanning.

To scan preset stations, press and hold either the SCAN or the TYPE arrows for more than four seconds. PSC displays and a double beep sounds. The radio goes to a preset station, plays for a few seconds, then goes to the next preset station. Press either the SCAN or the TYPE arrows again to stop scanning presets.

The radio only scans stations with a strong signal that are in the selected band.

## Setting Preset Stations

Up to 30 stations (six FM1, six FM2, and six AM, six XM1 and six XM2 (if equipped)), can be programmed on the six numbered pushbuttons, by performing the following steps:

1. Turn the radio on.
2. Press BAND to select FM1, FM2, AM, or XM1 or XM2.
3. Tune in the desired station.
4. Press and hold one of the six numbered pushbuttons until a beep sounds. Whenever that numbered pushbutton is pressed, the station that was set, returns.
5. Repeat the steps for each pushbutton.

To store an equalization setting to a preset station perform the following:

1. Tune to the preset station.
2. Press and release the AUTO EQ button to select the equalization setting.

Once the equalization no longer displays, the equalization is set for that preset station.

## Setting the Tone (Bass/Midrange/Treble)

**AUDIO:** Push and release the AUDIO knob until BASS, MID (midrange) (without Bose®), or TREB (treble) displays. Turn the knob to increase or to decrease the tone. The display shows the bass, midrange (without Bose®), or treble level. If a station is weak or has static, decrease the treble.

To adjust the bass, midrange (without Bose®), or treble to the middle position while it is displayed, push and hold the AUDIO knob. The radio produces one beep and adjusts the display level to the middle position.

To adjust all tone and speaker controls to the middle position, push and hold the AUDIO knob when no tone or speaker controls displays. ALL CENTERED displays and a beep sounds.

**AUTO EQ (Automatic Equalization):** Press this button to select customized equalization settings designed for country/western, jazz, talk, pop, rock, and classical.

The radio saves separate AUTO EQ settings for each preset and source.

If the radio has the Bose® audio system, the equalization settings are either CUSTOM or TALK.

### **Adjusting the Speakers (Balance/Fade)**

**AUDIO:** To adjust the balance between the right and the left speakers, push and release the AUDIO knob until BAL (balance) displays. Turn the knob to move the sound toward the right or the left speakers.

To adjust the fade between the front and rear speakers, push and release the AUDIO knob until FAD (fade) displays. Turn the knob to move the sound toward the front or the rear speakers.

To adjust the balance or fade to the middle position while it is displayed, push and hold the AUDIO knob. The radio produces one beep and adjusts the display level to the middle position.

To adjust all tone and speaker controls to the middle position, push and hold the AUDIO knob when no tone or speaker controls display. ALL CENTERED displays and a beep sounds.

### **Finding a Program Type (PTY) Station (RDS and XM™)**

To select and find a desired PTY perform the following:

1. Press the TYPE button to activate program type select mode. P-TYPE and the last selected PTY displays.
2. Turn the TYPE knob or press and release the TYPE button to select a PTY.
3. Once the desired PTY displays, press either the TYPE or the SEEK arrows to select and to go to the PTY's first station.
4. To go to another station within that PTY, press the TYPE button, then press either the TYPE or the SEEK arrows once.
5. Press either the TYPE or the SEEK arrows twice to exit the program type select mode.

**SCAN:** Scan the stations within a PTY by performing the following:

1. Press the TYPE button to activate program type select mode. P-TYPE and the last selected PTY displays.
2. Turn the TYPE knob or press and release the TYPE button to select a PTY.
3. Once the desired PTY displays, press and hold either the TYPE or the SCAN arrows for two seconds, and the radio begins scanning the stations in the PTY.
4. Press either the TYPE or the SCAN arrows to stop scanning.

**BAND (Alternate Frequency):** Alternate frequency lets the radio switch to a stronger station with the same program type. To turn alternate frequency on, press and hold BAND for two seconds. AF ON displays. The radio can switch to stations with a stronger frequency.

To turn alternate frequency off, press and hold BAND again for two seconds. AF OFF displays. The radio does not switch to other stations.

This function does not apply for XM™ Satellite Radio Service.

## Setting Preset PTYs (RDS Only)

These pushbuttons have factory PTY presets. Up to 12 PTYs (six FM1 and six FM2), can be programmed on the six numbered pushbuttons, by performing the following steps:

1. Press BAND to select FM1 or FM2.
2. Press the TYPE button to activate program type select mode. P-TYPE and the last selected PTY displays.
3. Turn the TYPE knob or press and release the TYPE button to select a PTY.
4. Press and hold one of the six numbered pushbuttons until a beep sounds. When that numbered pushbutton is pressed (while in PTY mode), the PTY that was set, returns.
5. Repeat the steps for each pushbutton.

## RDS Messages

**INFO (Information):** If the current station has a message, INFO displays. Press this button to see the message. The message can display the artist, song title, call in phone numbers, etc.

If the entire message is not displayed, parts of the message appears every three seconds. To scroll through the message, press and release the INFO button. A new group of words displays after every press of this button. Once the complete message has displayed, INFO disappears from the display until another new message is received. The last message is displayed by pressing the INFO button. View the last message until a new message is received or you tune to a different station.

## Radio Messages

**CAL ERR (Calibration Error):** The audio system has been calibrated for your vehicle from the factory. If CAL ERR displays, it means that the radio has not been configured properly for the vehicle and must be returned to your dealer for service.

**LOCKED:** This message is displayed when the THEFTLOCK® system has locked up. Take the vehicle to your dealer for service.

If any error occurs repeatedly, or if an error cannot be corrected, contact your dealer.

## Radio Messages for XM™ Only

See *XM Radio Messages on page 274* later in this section for further detail.

## Playing a CD

If the ignition or radio is turned off, with a CD in the player, it stays in the player. When the ignition or radio is turned on, the CD starts playing where it stopped, if it was the last selected audio source.

When a CD is inserted, the CD symbol displays. As each new track starts to play, the track number displays.

The CD player can play the smaller 3 inch (8 cm) single CDs with an adapter ring. Full-size CDs and the smaller CDs are loaded in the same manner.

If playing a CD-R, the sound quality can be reduced due to CD-R quality, the method of recording, the quality of the music that has been recorded, and the way the CD-R has been handled. There can be an increase in skipping, difficulty in finding tracks, and/or difficulty in loading and ejecting. If these problems occur, check the bottom surface of the CD. If the surface of the CD is damaged, such as cracked, broken, or scratched, the CD will not play properly. If the surface of the CD is soiled, see *Care of Your CDs and DVDs on page 296* for more information.

If there is no apparent damage, try a known good CD.

Do not add any label to a CD, it could get caught in the CD player. If a CD is recorded on a personal computer and a description label is needed, try labeling the top of the recorded CD with a marking pen.

**Notice:** If you add any label to a CD, insert more than one CD into the slot at a time, or attempt to play scratched or damaged CDs, you could damage the CD player. When using the CD player, use only CDs in good condition without any label, load one CD at a time, and keep the CD player and the loading slot free of foreign materials, liquids, and debris.

If an error appears on the display, see “CD Messages” later in this section.

**LOAD:** Press this button to load CDs into the CD player. This CD player holds up to six CDs.

To insert one CD, do the following:

1. Turn the ignition on.
2. Press and release the LOAD button.
3. Wait for the indicator light, located to the right of the slot, to turn green.
4. Load a CD. Insert the CD part way into the slot, label side up. The player pulls the CD in.

To insert multiple CDs, do the following:

1. Turn the ignition on.
2. Press and hold the LOAD button for two seconds.

A beep sounds and the indicator light, located to the right of the slot, begins to flash and MULTI LOAD # displays.

3. Once the light stops flashing and turns green, INSERT CD # displays, load a CD. Insert the CD part way into the slot, label side up. The player pulls the CD in.

Once the CD is loaded, the indicator light begins flashing again. Once the light stops flashing and turns green, you can load another CD. The CD player takes up to six CDs. Do not try to load more than six.

To load more than one CD but less than six, complete Steps 1 through 3. When finished loading CDs, press the LOAD button to cancel the loading function. The radio begins to play the last CD loaded.

If more than one CD has been loaded, a number for each CD displays.

## Playing a Specific Loaded CD

For every CD loaded, a number displays. To play a specific CD, first press the CD AUX button (if not already in CD mode), then press the numbered pushbutton that corresponds to the CD. A small bar displays under the CD number that is playing and the track number displays.

If an error displays, see “CD Messages” later in this section.

**CD  (Eject):** Press this button to eject CD(s).

To eject the CD that is currently playing, press and release this button.

To eject multiple CDs, do the following:

1. Press and hold the CD eject button for two seconds.

A beep sounds and the indicator light, located to the right of the slot, begins to flash and EJECT ALL displays.

2. Once the light stops flashing, REMOVE CD # displays. The CD ejects and can be removed. Once the CD is removed, the indicator light begins flashing again and another CD ejects.

To stop ejecting the CDs, press the eject button.

If the CD is not removed, after 25 seconds, the CD automatically pulls back into the player. If CD is pushed back into the player, before the 25-second time period is complete, the player senses an error and tries to eject the CD several times before stopping.

Do not repeatedly press the CD eject button to eject a CD after you have tried to push it in manually. The player's 25-second eject timer resets at each press of eject, causing the player to not eject the CD until the 25-second time period has elapsed.

◀ **REV (Reverse):** Press and hold this button to reverse quickly within a track. You will hear sound at a reduced volume. Release the button to play the passage. The elapsed time of the track displays.

**FWD** ▶▶ **(Forward):** Press and hold this button to advance quickly within a track. You will hear sound at a reduced volume. Release the button to play the passage. The elapsed time of the track displays.

**RPT (Repeat):** With the repeat setting, one track or an entire CD can be repeated.

To use repeat, do the following:

- To repeat the track you are listening to, press and release the RPT button. RPT displays. Press RPT again to turn off repeat play.
- To repeat the CD you are listening to, press and hold the RPT button for two seconds. RPT displays. Press RPT again to turn off repeat play.

**RDM (Random):** With the random setting, you can listen to the tracks in random, rather than sequential, order, on one CD or on all of the CDs. To use random, do one of the following:

- To play the tracks on the CD you are listening to in random order, press and release the RDM button. RANDOM ONE displays. Press RDM again to turn off random play.
- To play the tracks on all of the CDs that are loaded in random order, press and hold RDM for more than two seconds. A beep sounds and RANDOM ALL displays. Press RDM again to turn off random play.



**AUTO EQ (Automatic Equalization):** Press AUTO EQ to select the equalization setting while playing a CD. The equalization is stored whenever a CD is played. For more information on AUTO EQ, see “AUTO EQ” listed previously in this section.

◀ **SEEK** ▶ : Press the left arrow to go to the start of the current track, if more than ten seconds have played. Press the right arrow to go to the next track. If either arrow is pressed more than once, the player continues moving backward or forward through the CD.

◀ **SCAN** ▶ : To scan one CD, press and hold either SCAN arrow for more than two seconds until TRACK SCAN displays and a beep sounds. The radio goes to the next track, plays for 10 seconds, then goes to the next track. Press either SCAN arrow again, to stop scanning.

To scan all loaded CDs, press and hold either SCAN arrow for more than four seconds until ALL CD SCAN displays and a beep sounds. Use this feature to listen to 10 seconds of the first track of each loaded CD. Press either SCAN arrow again, to stop scanning.

**INFO (Information):** Press this knob to see how long the current track has been playing. To change the default on the display, track or elapsed time, press the knob until you see the desired display, then press and hold the knob until a beep sounds. The selected display becomes the default.

**BAND:** Press this button to listen to the radio when a CD is playing. The inactive CD(s) remains inside the radio for future listening.

## Using Song List Mode

The six-disc CD changer has a feature called song list. This feature is capable of saving 20 track selections.

To save tracks into the song list feature, perform the following steps:

1. Turn the CD player on and load it with at least one CD. See “LOAD CD” listed previously in this section for more information.
2. Check to see that the CD changer is not in song list mode. S-LIST should not appear on the display. If S-LIST is displayed, press the SONG LIST button to turn it off.

3. Select the desired CD by pressing the numbered pushbutton and then use the SEEK or TYPE right arrow to locate the track to be saved. The track begins to play.
4. Press and hold the SONG LIST button to save the track into memory. When SONG LIST is pressed, one beep sounds. After two seconds of continuously pressing the SONG LIST button, two beeps sound to confirm the track has been saved.
5. Repeat Steps 3 and 4 for saving other selections.

S-LIST FULL displays if you try to save more than 20 selections.

To play the song list, press the SONG LIST button. One beep sounds and S-LIST displays. The recorded tracks begin to play in the order they were saved.

Seek through the song list by using the SEEK or TYPE arrows. Seeking past the last saved track returns to the first saved track.

To delete tracks from the song list, perform the following steps:

1. Turn the CD player on.
2. Press the SONG LIST button to turn song list on. S-LIST displays.
3. Press either SEEK or TYPE arrow to select the desired track to be deleted.
4. Press and hold the SONG LIST button for two seconds. When SONG LIST is pressed, one beep sounds. After two seconds of continuously pressing the SONG LIST button, two beeps sound to confirm that the track has been deleted.

After a track has been deleted, the remaining tracks are moved up the list. When another track is added to the song list, the track is added to the end of the list.

To delete the entire song list, perform the following steps:

1. Turn the CD player on.
2. Press the SONG LIST button to turn song list on. S-LIST displays.
3. Press and hold the SONG LIST button for more than four seconds. One beep sounds, followed by two beeps after two seconds, and a final beep sounds after four seconds. S-LIST EMPTY displays indicating the song list has been deleted.

If a CD is ejected, and the song list contains saved tracks from that CD, those tracks are automatically deleted from the song list. Any tracks saved to the song list again are added to the bottom of the list.

To end song list mode, press the SONG LIST button. One beep sounds and S-LIST is removed from the display.

## CD Messages

**CHECK CD:** If this message appears on the display and/or the CD ejects, it could be for one of the following reasons:

- It is very hot. When the temperature returns to normal, the CD should play.
- You are driving on a very rough road. When the road becomes smoother, the CD should play.
- The CD is dirty, scratched, wet, or upside down.
- The air is very humid. If so, wait about an hour and try again.
- There could have been a problem while burning the CD.
- The label could be caught in the CD player.

If the CD is not playing correctly, for any other reason, try a known good CD.

If any error occurs repeatedly or if an error cannot be corrected, contact your dealer. If the radio displays an error message, write it down and provide it to your dealer when reporting the problem.

## Listening to a DVD

If your vehicle has the Rear Seat Entertainment (RSE) system and a DVD is playing, the DVD symbol displays indicating that the DVD is available and can be listened to through your vehicle's speakers.

To listen to the DVD, press the CD AUX button until RSE displays. The current radio source stops and the DVD sound comes through the speakers.

To stop listening to the DVD, press the CD AUX button, if a CD is loaded, or press the BAND button to select a different source.

When the RSE system is turned off, the DVD symbol goes off of the radio display and RSE OFF displays. The radio returns to the last radio source that you were listening to.

See *Rear Seat Entertainment System on page 277* for more information.

## Using an MP3

### MP3 CD-R Disc MP3 Format

If you burn your own MP3 disc on a personal computer:

- Make sure the MP3 files are recorded on a CD-R disc.
- Do not mix standard audio and MP3 files on one disc.
- Make sure playlists have a .m3u or .wpl extension, other file extensions may not work.
- Files can be recorded with a variety of fixed or variable bit rates. Song title, artist name, and album is available for display by the radio when recorded using ID3 tags version 1 and 2.
- Create a folder structure that makes it easy to find songs while driving. Organize songs by albums using one folder for each album. Each folder or album should contain 18 songs or less.
- Make sure to finalize the disc when burning an MP3 disc, using multiple sessions. It is usually better to burn the disc all at once.

The player is able to read and play a maximum of 50 folders, 50 playlists, 10 sessions, and 255 files. Long file names, folder names, or playlist names can use more disc memory space than necessary. To conserve space on the disc, minimize the length of the file, folder, or playlist names. You can also play an MP3 CD that was recorded using no file folders. The system can support up to 11 folders in depth, though, keep the depth of the folders to a minimum in order to keep down the complexity and confusion in trying to locate a particular folder during playback. If a CD contains more than the maximum of 50 folders, 50 playlists, 10 sessions, and 255 files the player lets you access and navigate up to the maximum, but all items over the maximum are ignored.

### **Root Directory**

The root directory is treated as a folder. If the root directory has compressed audio files, the directory displays as F1 ROOT. All files contained directly under the root directory are accessed prior to any root directory folders. However, playlists (Px) are always accessed before root folders or files.

### **Empty Directory or Folder**

If a root directory or a folder exists somewhere in the file structure that contains only folders/ subfolders and no compressed files directly beneath them, the player advances to the next folder in the file structure that contains compressed audio files. The empty folder does not display.

### **No Folder**

When the CD contains only compressed files, the files are located under the root folder. The next and previous folder functions do not function on a CD that was recorded without folders or playlists. When displaying the name of the folder the radio displays ROOT.

When the CD contains only playlists and compressed audio files, but no folders, all files are located under the root folder. The folder down and the folder up buttons search playlists (Px) first and then goes to the root folder. When the radio displays the name of the folder the radio displays ROOT.

## Order of Play

Tracks are played in the following order:

- Play begins from the first track in the first playlist and continues sequentially through all tracks in each playlist. When the last track of the last playlist has played, play continues from the first track of the first playlist.
- If the CD does not contain any playlists, then play begins from the first track under the root directory. When all tracks from the root directory have played, play continues from files according to their numerical listing. After playing the last track from the last folder, play begins again at the first track of the first folder or root directory.

When play enters a new folder, the display does not automatically show the new folder name unless the folder mode has been chosen as the default display. See DISPL later in this section for more information. The new track name appears on the display.

## File System and Naming

The song name that displays is the song name that is contained in the ID3 tag. If the song name is not present in the ID3 tag, then the radio displays the file name without the extension (such as .mp3) as the track name.

Track names longer than 32 characters or four pages are shortened. Parts of words on the last page of text and the extension of the filename does not display.

## Preprogrammed Playlists

Preprogrammed playlists that were created using WinAmp™, MusicMatch™, or Real Jukebox™ software can be accessed, however, they cannot be edited using the radio. These playlists are treated as special folders containing compressed audio song files.

## Playing an MP3

Insert a CD partway into the slot, label side up. The player pulls it in, and READING displays. The CD should begin playing and the CD symbol displays. If you want to insert a CD with the ignition off, first press the eject button or the DISPL knob.

If the ignition or radio is turned off with a CD in the player it stays in the player. When the ignition or radio is turned on, the CD starts to play where it stopped, if it was the last selected audio source.

As each new track starts to play, the track number displays.

The CD player can play the smaller 3 inch (8 cm) single CDs with an adapter ring. Full-size CDs and the smaller CDs are loaded in the same manner.

If playing a CD-R, the sound quality can be reduced due to CD-R quality, the method of recording, the quality of the music that has been recorded, and the way the CD-R has been handled. There can be an increase in skipping, difficulty in finding tracks, and/or difficulty in loading and ejecting. If these problems occur, check the bottom surface of the CD. If the surface of the CD is damaged, such as cracked, broken, or scratched, the CD will not play properly. If the surface of the CD is soiled, see *Care of Your CDs and DVDs on page 296* for more information.

If there is no apparent damage, try a known good CD.

Do not add any label to a CD, it could get caught in the CD player. If a CD is recorded on a personal computer and a description label is needed, try labeling the top of the recorded CD with a marking pen.

**Notice:** If you add any label to a CD, insert more than one CD into the slot at a time, or attempt to play scratched or damaged CDs, you could damage the CD player. When using the CD player, use only CDs in good condition without any label, load one CD at a time, and keep the CD player and the loading slot free of foreign materials, liquids, and debris.

If an error displays, see “CD Messages” later in this section.

**1 FLD ▾ (Previous Folder):** Press this pushbutton to go to the first track in the previous folder. Press this button while in folder random to go to the first track in the previous folder and random the tracks in that folder.

**2 FLD  $\triangle$  (Next Folder):** Press this pushbutton to go to the first track in the next folder. Press this button while in folder random to go to the first track in the next folder and random the tracks in that folder.

**3 REV (Reverse):** Press and hold this pushbutton to reverse quickly within a track. Press and hold this pushbutton for less than two seconds to reverse at 10 times the normal playing speed. Press and hold it for more than two seconds to reverse at 20 times the normal playing speed. Release this pushbutton to play the passage. REV and the elapsed time of the track displays.

**4 FWD (Forward):** Press and hold this pushbutton to advance quickly within a track. Press and hold this pushbutton for less than two seconds to advance at 10 times the normal playing speed. Press and hold it for more than two seconds to advance at 20 times the normal playing speed. Release this pushbutton to play the passage. FWD and the elapsed time of the track displays.

**6 RDM (Random):** Press and release this pushbutton to play the tracks of a current folder or playlist, in random order. FLDR RDM displays. Once all of the tracks a current folder or playlist have played the system moves on to the next folder or playlist and play all of the tracks in random order.

To random all the tracks on the CD, press and hold this pushbutton for two seconds. A beep sounds and DISC RDM displays. This feature does not work with playlists.

When in random, pressing and releasing either SEEK arrow takes you to the next or previous random track.

Press and release this pushbutton again to turn off random play. NO RDM displays.

**$\triangleleft$  SEEK  $\triangleright$  :** Press the left arrow to go to the start of the previous track. Press the right arrow to go to the start of the next track. Pressing either arrow for more than two seconds searches the previous or next tracks at two tracks per second. Release the button to stop searching and to play the track.



◀ **TUNE** ▶ : Turn the TUNE knob to fast track reverse or advance through the tracks in all folders or playlists. The track number and file name displays for each track. Turning this knob while in random will fast track reverse or advance the tracks in sequential order.

**DISPL (Display):** Press this knob to switch between track mode, folder/playlist mode, and time of day mode. The display shows only eight characters, but there can be up to four pages of text. If there are more than eight characters in the song, folder, or playlist name, they are displayed if the knob is not pressed again, pressing this knob within two seconds takes you to the next display mode.

- Track mode displays the current track number and the ID3 tag song name.
- Folder/playlist mode displays the current folder or playlist number and the folder/playlist name.
- Time of day mode displays the time of day and the ID3 tag song name.

To change the default on the display, press the DISPL knob until you see the desired display, then press and hold this knob for two seconds. The radio produces one beep and the selected display becomes the default.

**INFO (Information):** INFO displays when a current track has ID3 tag information. Press this button to display the artist name and album contained in the tag. INFO disappears from the display when the information in the ID3 tag has finished.

**BAND:** Press this button to listen to the radio when a CD is playing. The inactive CD remains inside the radio for future listening.

**CD AUX (Auxiliary):** Press this button to play a CD when listening to the radio. The CD symbol displays when a CD is loaded.

⏏ (**Eject**): Press this button to eject a CD. Eject can activate with either the ignition or radio off. CDs can be loaded with the ignition and radio off if this button is pressed first.

## XM Radio Messages

If you have a Radio with CD or Radio with Six-Disc CD, you can receive these radio display messages.

Radio Display Message	Condition	Action Required
XL (Explicit Language Channels)	XL on the radio display, after the channel name, indicates content with explicit language.	These channels, or any others, can be blocked at a customer's request, by calling 1-800-852-XXM (9696).
Updating	Updating encryption code	The encryption code in the receiver is being updated, and no action is required. This process should take no longer than 30 seconds.
No Signal	Loss of signal	The system is functioning correctly, but the vehicle is in a location that is blocking the XM™ signal. When you move into an open area, the signal should return.
Loading XM	Acquiring channel audio (after 4 second delay)	The audio system is acquiring and processing audio and text data. No action is needed. This message should disappear shortly.
CH Off Air	Channel not in service	This channel is not currently in service. Tune to another channel.
CH Unavail	Channel no longer available	This previously assigned channel is no longer assigned. Tune to another station. If this station was one of the presets, choose another station for that preset button.
No Info	Artist Name/Feature not available	No artist information is available at this time on this channel. The system is working properly.

<b>Radio Display Message</b>	<b>Condition</b>	<b>Action Required</b>
No Info	Song/Program Title not available	No song title information is available at this time on this channel. The system is working properly.
No Info	Category Name not available	No category information is available at this time on this channel. The system is working properly.
No Info	No Text/Informational message available	No text or informational messages are available at this time on this channel. The system is working properly.
Not Found	No channel available for the chosen category	There are no channels available for the selected category. The system is working properly.
XM Locked	Theft lock active	The XM™ receiver in the vehicle may have previously been in another vehicle. For security purposes, XM™ receivers cannot be swapped between vehicles. If this message is received after having your vehicle serviced, check with your dealer.
Radio ID	Radio ID label (channel 0)	If tuned to channel 0, this message alternates with the XM™ Radio 8 digit radio ID label. This label is needed to activate the service.
Unknown	Radio ID not known (should only be if hardware failure)	If this message is received when tuned to channel 0, there could be a receiver fault. Consult with your dealer.
Chk XMRCvr	Hardware failure	If this message does not clear within a short period of time, the receiver could have a fault. Consult with your dealer.

If you have a Radio with CD (MP3), you can receive these radio display messages.

<b>Radio Display Message</b>	<b>Condition</b>	<b>Action Required</b>
XL (Explicit Language Channels)	XL on the radio display, after the channel name, indicates content with explicit language.	These channels, or any others, can be blocked at a customer's request, by calling 1-800-852-XXXM (9696).
Updating	Updating encryption code	The encryption code in the receiver is being updated, and no action is required. This process should take no longer than 30 seconds.
No Signl	Loss of signal	The system is functioning correctly, but the vehicle is in a location that is blocking the XM™ signal. When the vehicle is moved into an open area, the signal should return.
Loading	Acquiring channel audio (after 4 second delay)	The radio system is acquiring and processing audio and text data. No action is needed. This message should disappear shortly.
Off Air	Channel not in service	This channel is not currently in service. Tune to another channel.
CH Unavl	Channel no longer available	This previously assigned channel is no longer assigned. Tune to another station. If this station was one of the presets, choose another station for that preset button.
No Info	Artist Name/Feature not available	No artist information is available at this time on this channel. The system is working properly.
No Info	Song/Program Title not available	No song title information is available at this time on this channel. The system is working properly.
No Info	Category Name not available	No category information is available at this time on this channel. The system is working properly.
No Info	No Text/Informational message available	No text or informational messages are available at this time on this channel. The system is working properly.

Radio Display Message	Condition	Action Required
Not Found	No channel available for the chosen category	There are no channels available for the selected category. The system is working properly.
XM Lock	Theft lock active	The XM™ receiver in your vehicle may have previously been in another vehicle. For security purposes, XM™ receivers cannot be swapped between vehicles. If this message is received after having your vehicle serviced, check with your dealer.
Radio ID	Radio ID label (channel 0)	If tuned to channel 0, this message will alternate with the XM™ Radio eight digit radio ID label. This label is needed to activate the service.
Unknown	Radio ID not known (should only be if hardware failure)	If this message is received when tuned to channel 0, there could be a receiver fault. Consult with your dealer.
Check XM	Hardware failure	If this message does not clear within a short period of time, the receiver could have a fault. Consult with your dealer.

## Navigation/Radio System

Your vehicle may have a navigation radio system.

The navigation system has built-in features intended to minimize driver distraction. Technology alone, no matter how advanced, can never replace your own judgment. See the Navigation System manual for some tips to help you reduce distractions while driving.

## Rear Seat Entertainment System

Your vehicle may have the Digital Versatile Disc (DVD) Rear Seat Entertainment (RSE) system. The RSE system includes a DVD player, a video display screen, two sets of wireless headphones, and a remote control.

## Parental Control

This button is located behind the video screen. Press this button while a DVD or CD is playing to freeze the video and mute the audio. The video screen will display Parental Control ON and the power indicator light on the DVD player will flash. It will also disable all other button operations from the remote control and the DVD player, with the exception of the eject button. Press this button again to restore operation of the DVD player.

This button may also be used to turn the DVD player power on and automatically resume play if the ignition is in RUN, ACCESSORY, or if RAP is active.

## Before You Drive

The RSE system is for rear seat passengers only. The driver cannot safely view the video screen while driving and should not try to do so.

## Headphones

The RSE system includes two sets of wireless headphones.

Each set of headphones has an ON/OFF control. An indicator light will illuminate on the headphones when they are on. If the light does not illuminate, the batteries may need to be replaced. See “Battery Replacement” following for more information.

Each set of headphones has a volume knob. To adjust the volume, adjust this knob.

The transmitters are located below the video display screen. The headphones will shut off automatically if they lose the signal from the system after about four minutes to save battery power. The signal may be lost if the system is turned off or if the headphones are out of range of the transmitters.

When using the wired headphones, if the front seat passengers play a CD in the Radio with Six-Disc CD (if equipped) or use XM™ Satellite Radio Service (if equipped), you will hear the audio for these sources, instead of the DVD or CD that is currently playing through the RSE.

**Notice: Do not store the headphones in heat or direct sunlight. This could damage the headphones and repairs will not be covered by your warranty. Keep the headphones stored in a cool, dry place.**

Both sets of rear seat headphones may include foam ear pads that can be replaced.

Foam ear pads on these headphones may become worn or damaged. The headphone foam ear pads can become damaged if they are not handled or stored properly. If the foam ear pads do become damaged or worn out, the pads can be replaced separately from the headphone set. It is not necessary to replace the complete headphone set.

The headphone replacement foam ear pads can be ordered in pairs. See your dealer for more information.

## **Battery Replacement**

To change the batteries, do the following:

1. Loosen the screw on the battery compartment door located on the left side of the headphone earpiece.
2. Replace the two AAA batteries in the compartment. Make sure that they are installed correctly, using the diagram on the inside of the battery compartment.
3. Tighten the screw to close the compartment door.

If the headphones are to be stored for a long period of time, remove the batteries and keep them in a cool, dry place.

## **Stereo RCA Jacks**

The RCA jacks are located behind the video screen. The RCA jacks allow audio and video signals to be connected from an auxiliary device such as a camcorder or a video game unit to the RSE system. Standard RCA cables, not included, are needed to connect the auxiliary device to the RCA jacks. The yellow connector inputs video and the red and white connectors input right and left audio. Refer to the manufacturer's instructions for proper connection of the auxiliary device.

To use the auxiliary inputs on the RSE system, connect an external auxiliary device to the color-coded RCA jacks and turn both the auxiliary device and the RSE system power on. If the RSE system had been previously in the DVD player mode, pressing the SRCE button on the faceplate or the remote control will switch the RSE system between the auxiliary device and the DVD player.

## How to Change the Video Format when in the Auxiliary Mode

The auxiliary input video format is preset to NTSC. In some countries, the video format may be in the PAL system. To change the video format, perform the following:

1. Press the display menu button.
2. Press the down arrow button to highlight the Video Format option.
3. Press the enter button to select Video Format.
4. Press the right or left arrow button to select the desired video format.
5. Press the enter button to accept the change.

## Audio Output

Audio from the DVD player or auxiliary inputs may be heard through the following possible sources:

- Wireless Headphones
- Vehicle Speakers
- Vehicle wired headphone jacks on the Rear Seat Audio system (if equipped)

The RSE system will always transmit the audio signal by infrared to the wireless headphones, if there is audio available. See “Headphones” previously for more information.

The RSE system is capable of outputting audio to the vehicle speakers by using the radio. The RSE system may be selected as an audio source on the radio if the RSE system power is on. Once the RSE system is selected as an audio source on the radio, adjust the speaker volume on the radio, if necessary. If the RSE system power is not on, the RSE system will not be an available source on the radio. Refer to the radio information for the radio that your vehicle has for more information.

The RSE system is capable of outputting audio to the wired headphone jacks on the rear seat audio system (if equipped). The RSE system may be selected as an audio source on the rear seat audio system if the RSE system power is on. Refer to *Rear Seat Audio (RSA) on page 292* for more information.



## Video Screen

The video screen is located in the overhead console.

To use the video screen, do the following:

1. Push forward on the release button located on the DVD display console.
2. Pull the screen down, away from you, and adjust its position as desired.

When the video screen is not in use, push it up into its locked position.

If a DVD is playing and the screen is raised to its locked position, the screen will shut off, but the DVD will continue to play through the previous audio or video source.

The video screen contains the IR transmitters for the wireless headphones and the IR receivers for the remote control. If the screen is in the closed position, the signals will not be available for the operation of the headphones or the remote control.

**Notice:** Avoid directly touching the video screen, as damage may occur. See “Cleaning the Video Screen” later in this section for more information.

## DVD Player

The DVD player is located in the overhead console. The DVD player can be controlled by the buttons on the DVD player and/or by the buttons on the remote control. See “Remote Control” later in this section for more information.

The DVD player power may be turned on when the ignition is in RUN, ACCESSORY, or when Retained Accessory Power (RAP) is active.

The RSE system DVD player is only compatible with DVDs of the appropriate region code for the country that the vehicle was sold in. The DVD region code is printed on the jacket of most DVDs.

Standard audio CDs, CD-R, CD-RW, Video CD and Photo CD/CD-R media are fully supported by this DVD player. DVD-R and DVD-RW media is supported if formatted as DVD-Video. DVD+R and DVD+RW media may or may not be supported by the DVD player. The DVD player does not support DVD-RAM, DVD-ROM, and DVD Audio media. An error message will appear on the display if this type of media is inserted into the DVD player.

When using the wired headphones, not included, if the front seat passengers play a CD in the Radio with Six-Disc CD (if equipped) or use XM™ Satellite Radio Service (if equipped), you will hear the audio for these sources, instead of the DVD or CD that is currently playing through the RSE.

If an error message appears on the video screen, see “DVD Messages” later in this section.

## DVD Player Buttons (Without Sunroof)

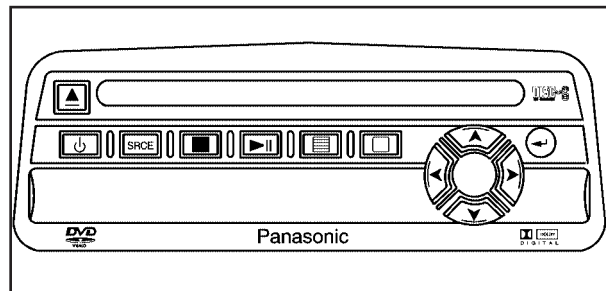

**⏻ (Power):** Press this button to turn the RSE system on and off. The power indicator light will illuminate when the power is on.

**▲ (Eject):** Press this button to eject a DVD or CD.

**SRCE (Source):** Press this button to switch between the DVD player and an auxiliary source.

■ **(Stop):** Press this button to stop playing, rewinding, or fast forwarding a DVD or CD. Press this button twice to return to the beginning of the DVD.

▶ || **(Play/Pause):** Press this button to start play of a DVD or CD. Press this button while a DVD or CD is playing to pause it. Press this button again to continue the play of the DVD or CD.

☰ **(Main DVD Menu):** Press this button to access the DVD menu. The DVD menu is different on every DVD. Use the up, down, left, and right arrow buttons to move the cursor around the DVD menu. After making a selection press the enter button. This button only operates when playing a DVD.

□ **(Set-up Menu):** Press this button to adjust the color, tint, brightness, contrast, display mode, and dynamic range compression. The dynamic range compression feature can be used to reduce loud audio and increase low audio produced by some DVDs.

To change a feature back to the factory default setting, press this button to display the feature, then press and hold this button. The default setting will appear on the display.

While playing an Audio or DVD disc, press and hold this button to display and to remove the track and time information.

▲, ▼, ◀, ▶ **(Menu Navigation Arrows):** Use the arrow buttons to navigate through a menu.

◀↵ **(Enter):** Press this button to select the choices that are highlighted in any menu.

## DVD Player Buttons (With Sunroof)

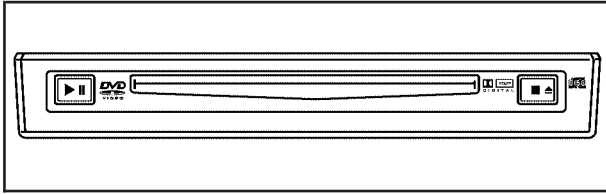

▶ || **(Play/Pause):** Press this button to start play of a DVD or CD. Press this button while a DVD or CD is playing to pause it. Press this button again to continue the play of the DVD or CD.

■ ▲ **(Stop/Eject):** Press this button to stop playing, rewinding, or fast forwarding a DVD or CD. Press this button twice to return to the beginning of the DVD.

Press and hold this button for more than three seconds to eject a DVD or CD.

### Playing a Disc

To play a disc, gently insert the disc with the label side up into the loading slot. The DVD player will continue loading the disc and the player will automatically start, if the vehicle is in RUN, ACCESSORY, or when RAP is active.

If a disc is already in the player, press the play/pause button on the DVD player faceplate or on the remote control.

Some DVDs will not allow fast forwarding or skipping of the copyright information or the previews. Some DVDs will begin playing after the previews have finished. If the DVD does not begin to play the main title, refer to the on-screen instructions.

### Stopping and Resuming Playback

To stop playing a disc, press and release the stop button on the DVD player faceplate or the remote control.

To resume playback, press the play/pause button on the DVD player faceplate or the remote control. The movie should resume play from where it was last stopped, if the disc has not been ejected and the stop button has not been pressed twice. If the disc has been ejected or if the stop button has been pressed twice, the disc will resume play at the beginning.

## Ejecting a Disc (DVD Player without Sunroof)

Press the eject button on the DVD player faceplate to eject the disc. There is not an eject button on the remote control.

If a disc is ejected from the player, but is not removed, the DVD player will reload the disc after a short period of time. The disc will be stored in the DVD player. The DVD player will not resume play of the disc automatically.

## Ejecting a Disc (DVD Player with Sunroof)

Press and hold the stop/eject button for more than two seconds on the DVD player faceplate to eject the disc. There is not an eject button on the remote control.

If a disc is ejected from the player, but is not removed, the DVD player will reload the disc after a short period of time. The disc will be stored in the DVD player. The DVD player will not resume play of the disc automatically.

## Remote Control

To use the remote control, aim it at the transmitter window below the video screen and press the desired button. Direct sunlight or very bright light may affect the ability of the RSE system to receive signals from the remote control. If the remote control does not seem to be working, the batteries may need to be replaced. See “Battery Replacement” later in this section.

Objects blocking the line of sight may also affect the function of the remote control.

**Notice:** Storing the remote control in a hot area or in direct sunlight may damage it, and the repairs will not be covered by your warranty. Keep the remote control stored in a cool, dry place.

To extend the life of the batteries, the remote control does not have a press and hold feature.

## Remote Control Buttons

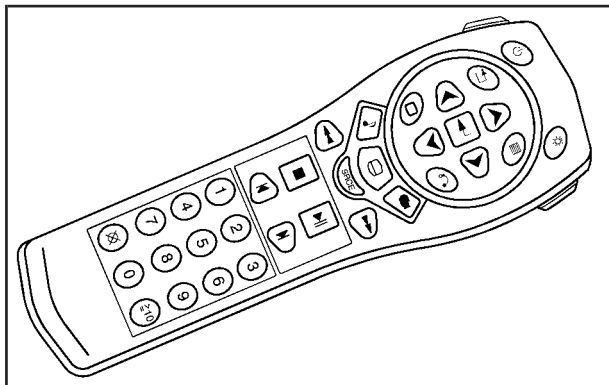



 **(Power):** Press this button to turn the DVD player on and off.

 **(Title):** Press this button to return the DVD to the main menu of the DVD.

 **(Menu Navigation Arrows):** Use the arrow buttons to navigate through a menu.

 **(Set-up Menu):** Press this button to adjust the color, tint, brightness, contrast, display mode, and dynamic range compression. The dynamic range compression feature can be used to reduce loud audio and increase low audio produced by some DVDs.

 **(Audio):** Press this button to display a menu that will only appear when a DVD is being played. The format and content of this function will vary for each disc.

 **(Fast Reverse):** Press this button to fast reverse the DVD or CD. To stop fast reversing, press this button again. This button may not work when the DVD is playing the copyright information or the previews.

**SRCE (Source):** Press this button to switch between the DVD player and an auxiliary source.

 **(Stop):** Press this button to stop playing, rewinding, or fast forwarding a DVD or CD. Press this button twice to return to the beginning of the DVD.

 **(Previous Track/Chapter):** Press this button to return to the start of the current track or chapter. Press this button again to return to the previous track or chapter. This button may not work when the DVD is playing the copyright information or the previews.

**1 through 0 (Numeric Keypad):** The numeric keypad provides you with the capability of direct chapter, title, and track number selection.

 **(Double Digit Entries):** Press this button to select chapter, title, and track numbers greater than 9. Press this button before inputting the number.

 **(Clear):** Press this button within three seconds after inputting a number to clear the number(s).

 **(Illumination):** Press this button to turn the remote control backlight on. The backlight will time out after about 7 to 10 seconds if no other button is pressed while the backlight is on.

 **(Main DVD Menu):** Press this button to access the DVD menu. The DVD menu is different on every DVD. Use the up, down, left, and right arrow buttons to move the cursor around the DVD menu. After making a selection press the enter button. This button only operates when playing a DVD.

 **(Enter):** Press this button to select the choices that are highlighted in any menu.

 **(Return):** Press this button to exit the current active menu and return to the previous menu. This button will operate only when a DVD is playing and a menu is active.

 **(Camera Angle):** Press this button to change camera angles on DVDs that have this feature when a DVD is playing. The format and content of this function will vary for each disc.

 **(Subtitle):** Press this button to turn on subtitles and to move through subtitle options when a DVD is playing. The format and content of this function will vary for each disc.

▶▶ **(Fast Forward):** Press this button to fast forward the DVD or CD. To stop fast forwarding, press this button again. This button may not work when the DVD is playing the copyright information or the previews.

▶ || **(Play/Pause):** Press this button to start play of a DVD or CD. Press this button while a DVD or CD is playing to pause it. Press this button again to continue the play of the DVD or CD.

When the DVD is playing, press the pause button then press the fast forward button. The DVD will continue playing in a slow play mode. To cancel slow play mode, press the play/pause button.

▶| **(Next Track/Chapter):** Press this button to advance to the beginning of the next track or chapter. This button may not work when the DVD is playing the copyright information or the previews.

## Battery Replacement

To change the batteries, do the following:

1. Remove the battery compartment door located on the bottom of the remote control.
2. Replace the two AA batteries in the compartment. Make sure that they are installed correctly, using the diagram on the inside of the battery compartment.
3. Close the battery door securely.

If the remote control is to be stored for a long period of time, remove the batteries and keep them in a cool, dry place.



<b>Problem</b>	<b>Recommended Action</b>
No power.	The ignition might not be in on or accessory. The parental control button might have been turned on. The power indicator light will flash.
Disc will not play.	The system might be off. The parental control button might have been turned on. The power indicator light will flash. The system might be in auxiliary mode. The disc is upside down or is not compatible.
The picture does not fill the screen. There are black borders on the top and bottom or on both sides or it looks stretched out.	Check the display mode settings in the display menu.
The disc was ejected, but it was pulled back into the DVD player.	The disc is being stored in the DVD player. Press the eject button again to eject the disc.

<b>Problem</b>	<b>Recommended Action</b>
In auxiliary mode, the picture moves or scrolls.	Check the auxiliary input connections at both devices. Change the Video Format to PAL or NTSC. See "Stereo RCA Jacks" previously for how to change the video format.
The language in the audio or on the screen is wrong.	Check the audio or language selection in the main DVD menu.
The remote control does not work.	Check to make sure there is no obstruction between the remote control and the transmitter window. Check the batteries to make sure they are not dead or installed incorrectly. The parental control button might have been turned on. The power indicator light will flash.

<b>Problem</b>	<b>Recommended Action</b>
After stopping the player, I push Play but sometimes the DVD starts where I left off and sometimes at the beginning.	If the stop button was pressed one time, the DVD player will resume playing where the DVD was stopped. If the stop button was pressed two times the DVD player will begin to play from the beginning of the DVD.
The auxiliary source is running but there is no picture or sound.	Check that the DVD player is in the auxiliary source mode. Check the auxiliary input connections at both devices.
My disc is stuck in the player. The Load/Eject button does not work.	Turn the DVD power off, then on, then press the load/eject button on the DVD player. Do not attempt to forcibly remove the disc from the DVD player. This could permanently damage the disc and DVD player.

<b>Problem</b>	<b>Recommended Action</b>
Sometimes the wireless headphone audio cuts out or buzzes.	Check for obstructions, low batteries, reception range, and interference from cellular telephone towers or by using your cellular telephone in the vehicle. Check that the headphones are facing the front of the vehicle.
I lost the remote and/or the headphones.	See your dealer for assistance.
The DVD is playing, but there is no picture or sound.	Check that the DVD player is in DVD mode.
The audio/video skips or jumps.	The DVD or CD could be dirty, scratched, or damaged.
The audio from the radio for the Radio with Six-Disc CD and XM™ has taken over the audio from the DVD or CD when using the wired headphones.	The RSE is working correctly. Use the wireless headphones or have the front seat passengers listen to another audio source.

## DVD Messages

The following errors may be displayed on the video screen:

**Disc Format Error:** This message will be displayed if a disc is inserted upside down, if the disc is not readable, or if the format is not compatible with the DVD player.

**Load/Eject Error:** This message will be displayed if the disc is not properly loaded or ejected.

**Disc Play Error:** This message will be displayed if the DVD player cannot play the disc. Scratched or damaged discs will cause this error.

**Region Code Error:** This message will be displayed if the region code of the DVD is not compatible with the region code of the DVD player.

**No Disc:** This message will be displayed if any of the buttons on the DVD faceplate or remote control are pressed and no disc is present in the DVD player.

## DVD Distortion

There may be an experience with audio distortion in the wireless headphones when operating cellular phones, scanners, CB radios, Global Positioning Systems (GPS)\*, two-way radios, mobile fax, or walkie talkies.

It may be necessary to turn off the DVD player when operating one of these devices in or near the vehicle.

\* Excludes the OnStar® System.

## Cleaning the Video Screen

Pour some isopropyl or rubbing alcohol on a clean cloth and gently wipe the video screen. Do not spray directly onto the screen and do not press too hard or too long on the video screen.

## Rear Seat Audio (RSA)

This feature allows rear seat passengers to listen to any of the sources: radio, cassette tapes, CDs, or DVDs. However, the rear seat passengers can only control the sources that the front seat passengers are not listening to. For example, rear seat passengers may listen to and control cassette tapes, CDs, or DVDs through the headphones while the driver listens to the radio through the front speakers. The rear seat passengers have control of the volume for each set of headphones.

The front seat audio controls always have priority over the RSA controls. If the front seat passengers switch the source for the main radio to a remote source, the RSA will not be able to control the source. You can operate the rear seat audio when the main radio is off.

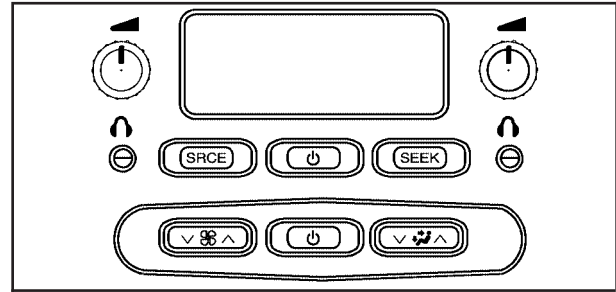

**⏻ (Power):** Press this button to turn the system on or off. The rear speakers will be muted when the power is turned on.

**◀ (Volume):** Turn this knob to increase or to decrease the volume. The left volume knob controls the left wired headphones and the right volume knob controls the right wired headphones.

**SRCE (Source):** Press this button to select a source: radio, cassette tape, CD, or DVD. The inactive tape, CD, or DVD will remain safely inside the radio for future listening.

**SEEK:** Press this button to advance to the next station or track and stay there. The display will show the selection. This function is inactive if the front seat passengers are listening to the same audio source.

To scan preset stations, press and hold the SEEK button for two seconds and the radio will advance to the next preset station. If you continue to hold the button down, the radio will continue to advance through the available preset stations. The display will show the selections. This function is inactive if the front seat passengers are listening to the radio.

When a cassette tape is playing, press the SEEK button to go to the next selection on the tape. Press and hold the SEEK button to go to the other side of the tape. This function is inactive if the front seat passengers are listening to a cassette tape.

When a CD is playing, press the SEEK button to go to the next track on the CD. This function is inactive if the front seat passengers are listening to a CD.

When a CD is playing in the six-disc CD player, press and hold the SEEK button for 2 seconds to go you to the next CD, if multiple CDs are loaded. This function is inactive if the front seat passengers are listening to a CD.

## Theft-Deterrent Feature

THEFTLOCK<sup>®</sup> is designed to discourage theft of your vehicle's radio. The feature works automatically by learning a portion of the Vehicle Identification Number (VIN). If the radio is moved to a different vehicle, it does not operate and LOCKED displays.

When the radio and vehicle are turned off, the blinking red light indicates that THEFTLOCK<sup>®</sup> is armed.

With THEFTLOCK<sup>®</sup> activated, the radio does not operate if stolen.

## Audio Steering Wheel Controls

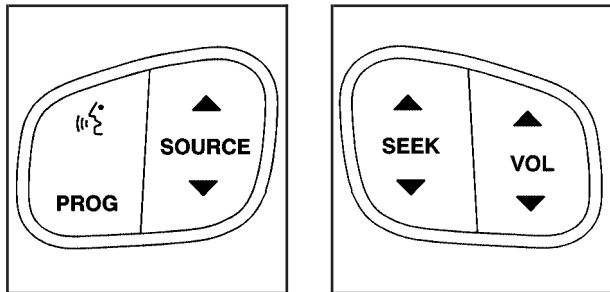

If your vehicle has this feature, some audio functions can be adjusted at the steering wheel. They include the following:

**☎ (OnStar®/Mute):** If your vehicle has OnStar, press this button to interact with the OnStar system. See the *OnStar® System on page 145* in this manual for more information.

If your vehicle does not have OnStar, press this button to silence the system. Press it again, or any other radio button, to turn on the sound.

**PROG (Program):** Press this button to play a station you have programmed on the radio preset pushbuttons. The radio will only seek preset stations with a strong signal that are in the selected band.

When a CD is playing in the CD changer, press this button to go to the next available CD, if multiple CDs are loaded.

**▲ SOURCE ▼:** Press this button to switch between FM1, FM2, AM, or XM1 or XM2 (if equipped), or a CD. If a CD is loaded the CD symbol will appear on the display.

**▲ SEEK ▼:** Press the up or the down arrow to go to the next or to the previous radio station and stay there. The radio will only seek stations with a strong signal that are in the selected band.

When a CD is playing, press the up or the down arrow to fast forward or reverse.

**▲ VOL ▼ (Volume):** Press the up or the down arrow to increase or to decrease the volume.

## Radio Reception

You may experience frequency interference and static during normal radio reception if items such as cellphone chargers, vehicle convenience accessories, and external electronic devices are plugged into the accessory power outlet. If there is interference or static, unplug the item from the accessory power outlet.

### AM

The range for most AM stations is greater than for FM, especially at night. The longer range can cause station frequencies to interfere with each other. For better radio reception, most AM radio stations boost the power levels during the day, and then reduce these levels during the night. Static can also occur when things like storms and power lines interfere with radio reception. When this happens, try reducing the treble on your radio.

## FM Stereo

FM stereo gives the best sound, but FM signals reach only about 10 to 40 miles (16 to 65 km). Tall buildings or hills can interfere with FM signals, causing the sound to fade in and out.

### XM™ Satellite Radio Service

XM™ Satellite Radio Service gives digital radio reception from coast-to-coast in the 48 contiguous United States, and in Canada. Just as with FM, tall buildings or hills can interfere with satellite radio signals, causing the sound to fade in and out. In addition, traveling or standing under heavy foliage, bridges, garages, or tunnels can cause loss of the XM™ signal for a period of time. The radio could display NO XM SIGNAL to indicate interference.

## Care of Your CDs and DVDs

Handle CDs carefully. Store them in their original cases or other protective cases and away from direct sunlight and dust. The CD player scans the bottom surface of the disc. If the surface of a CD is damaged, such as cracked, broken, or scratched, the CD does not play properly or not at all. If the surface of a CD is soiled, take a soft, lint free cloth or dampen a clean, soft cloth in a mild, neutral detergent solution mixed with water, and clean it. Make sure the wiping process starts from the center to the edge.

Do not touch the bottom side of a CD while handling it; this could damage the surface. Pick up CDs by grasping the outer edges or the edge of the hole and the outer edge.

## Care of the CD and DVD Player

The use of CD lens cleaners for CDs is not advised, due to the risk of contaminating the lens of the CD optics with lubricants internal to the CD mechanism.

## Fixed Mast Antenna

The fixed mast antenna can withstand most car washes without being damaged. If the mast should ever become slightly bent, straighten it out by hand. If the mast is badly bent, replace it.

Check occasionally to make sure the mast is still tightened to the fender. If tightening is required, tighten by hand, then with a wrench one quarter turn.



## **XM™ Satellite Radio Antenna System**

The XM™ Satellite Radio antenna is located on the roof of your vehicle. Keep this antenna clear of snow and ice build up for clear radio reception.

If your vehicle has a sunroof, the performance of the XM™ system may be affected if the sunroof is open.

Loading items onto the roof of your vehicle can interfere with the performance of the XM™ system. Make sure the XM™ Satellite Radio antenna is not obstructed.

## **Chime Level Adjustment**

The radio is used to adjust the vehicle's chime level. To change the volume level of the chime, press and hold pushbutton 6 with the ignition on and the radio power off. The volume level will change from the normal level to loud, and LOUD CHIME will appear on the radio display. To change back to the default or normal setting, press and hold pushbutton 6 again. The volume level will change from the loud level to normal, and NORMAL CHIME will appear on the radio display. Removing the radio and not replacing it with a factory radio or chime module will disable vehicle chimes.

 **NOTES**

---

---

---

---

---

---

---

---

---

---

---

---

---

---

---

---

---

---

---

---

---

---

## Section 4 Driving Your Vehicle

---

### Your Driving, the Road, and

<b>Your Vehicle</b> .....	300
Defensive Driving .....	300
Drunken Driving .....	301
Control of a Vehicle .....	304
Braking .....	304
Anti-Lock Brake System (ABS) .....	305
Braking in Emergencies .....	307
Locking Rear Axle .....	307
StabiliTrak® System .....	307
All-Wheel Drive (AWD) System (TrailBlazer SS) .....	311
Steering .....	312
Off-Road Recovery .....	314
Passing .....	314
Loss of Control .....	316
Competitive Driving .....	317
Off-Road Driving (Except SS) .....	317
Driving at Night .....	333
Driving in Rain and on Wet Roads .....	334

City Driving .....	338
Freeway Driving .....	339
Before Leaving on a Long Trip .....	340
Highway Hypnosis .....	341
Hill and Mountain Roads .....	342
Winter Driving .....	344
If Your Vehicle is Stuck in Sand, Mud, Ice, or Snow .....	348
Rocking Your Vehicle to Get It Out .....	348
Recovery Hooks .....	349
Loading Your Vehicle .....	350
Adding a Snow Plow or Similar Equipment .....	355
<b>Towing</b> .....	356
Towing Your Vehicle .....	356
Recreational Vehicle Towing .....	356
Electronically Controlled Air Suspension System .....	361
Towing a Trailer .....	363

# Your Driving, the Road, and Your Vehicle

## Defensive Driving

The best advice anyone can give about driving is: Drive defensively.

Please start with a very important safety device in your vehicle: Buckle up. See *Safety Belts: They Are for Everyone* on page 20.

### CAUTION:

Defensive driving really means “Be ready for anything.” On city streets, rural roads, or expressways, it means “Always expect the unexpected.” Assume that pedestrians or other drivers are going to be careless and make mistakes. Anticipate what they might do and be ready. Rear-end collisions are about the most preventable of accidents. Yet they are common. Allow enough following distance. Defensive driving requires that a driver concentrate on the driving task. Anything that distracts from the driving task makes proper defensive driving more difficult and can even cause a collision, with resulting injury. Ask a passenger to help do these things, or pull off the road in a safe place to do them. These simple defensive driving techniques could save your life.

## Drunken Driving

Death and injury associated with drinking and driving is a national tragedy. It is the number one contributor to the highway death toll, claiming thousands of victims every year.

Alcohol affects four things that anyone needs to drive a vehicle:

- Judgment
- Muscular Coordination
- Vision
- Attentiveness

Police records show that almost half of all motor vehicle-related deaths involve alcohol. In most cases, these deaths are the result of someone who was drinking and driving. In recent years, more than 16,000 annual motor vehicle-related deaths have been associated with the use of alcohol, with more than 300,000 people injured.

Many adults — by some estimates, nearly half the adult population — choose never to drink alcohol, so they never drive after drinking. For persons under 21, it is against the law in every U.S. state to drink alcohol. There are good medical, psychological, and developmental reasons for these laws.

The obvious way to eliminate the leading highway safety problem is for people never to drink alcohol and then drive. But what if people do? How much is “too much” if someone plans to drive? It is a lot less than many might think. Although it depends on each person and situation, here is some general information on the problem.

The Blood Alcohol Concentration (BAC) of someone who is drinking depends upon four things:

- The amount of alcohol consumed
- The drinker’s body weight
- The amount of food that is consumed before and during drinking
- The length of time it has taken the drinker to consume the alcohol

According to the American Medical Association, a 180 lb (82 kg) person who drinks three 12 ounce (355 ml) bottles of beer in an hour will end up with a BAC of about 0.06 percent. The person would reach the same BAC by drinking three 4 ounce (120 ml) glasses of wine or three mixed drinks if each had 1-1/2 ounces (45 ml) of liquors like whiskey, gin, or vodka.

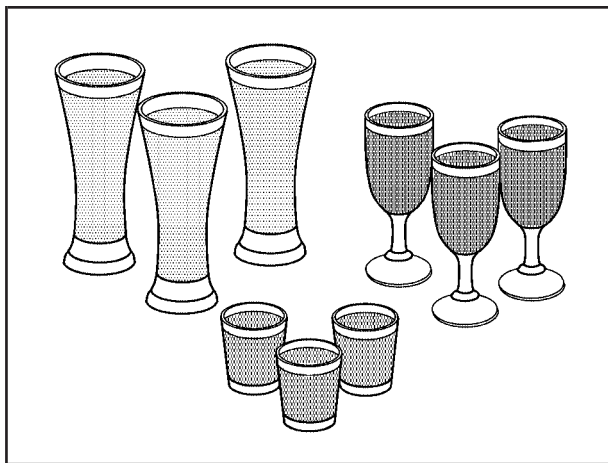

It is the amount of alcohol that counts. For example, if the same person drank three double martinis (3 ounces or 90 ml of liquor each) within an hour, the person's BAC would be close to 0.12 percent. A person who consumes food just before or during drinking will have a somewhat lower BAC level.

There is a gender difference, too. Women generally have a lower relative percentage of body water than men. Since alcohol is carried in body water, this means that a woman generally will reach a higher BAC level than a man of her same body weight will when each has the same number of drinks.

The law in most U.S. states, and throughout Canada, sets the legal limit at 0.08 percent. In some other countries, the limit is even lower. For example, it is 0.05 percent in both France and Germany. The BAC limit for all commercial drivers in the United States is 0.04 percent.

The BAC will be over 0.10 percent after three to six drinks (in one hour). Of course, as we have seen, it depends on how much alcohol is in the drinks, and how quickly the person drinks them.

But the ability to drive is affected well below a BAC of 0.10 percent. Research shows that the driving skills of many people are impaired at a BAC approaching 0.05 percent, and that the effects are worse at night. All drivers are impaired at BAC levels above 0.05 percent. Statistics show that the chance of being in a collision increases sharply for drivers who have a BAC of 0.05 percent or above. A driver with a BAC level of 0.06 percent has doubled his or her chance of having a collision. At a BAC level of 0.10 percent, the chance of this driver having a collision is 12 times greater; at a level of 0.15 percent, the chance is 25 times greater!

The body takes about an hour to rid itself of the alcohol in one drink. No amount of coffee or number of cold showers will speed that up. “I will be careful” is not the right answer. What if there is an emergency, a need to take sudden action, as when a child darts into the street? A person with even a moderate BAC might not be able to react quickly enough to avoid the collision.

There is something else about drinking and driving that many people do not know. Medical research shows that alcohol in a person’s system can make crash injuries worse, especially injuries to the brain, spinal cord, or heart. This means that when anyone who has been drinking — driver or passenger — is in a crash, that person’s chance of being killed or permanently disabled is higher than if the person had not been drinking.

 **CAUTION:**

**Drinking and then driving is very dangerous. Your reflexes, perceptions, attentiveness, and judgment can be affected by even a small amount of alcohol. You can have a serious — or even fatal — collision if you drive after drinking. Please do not drink and drive or ride with a driver who has been drinking. Ride home in a cab; or if you are with a group, designate a driver who will not drink.**

## Control of a Vehicle

You have three systems that make your vehicle go where you want it to go. They are the brakes, the steering, and the accelerator. All three systems have to do their work at the places where the tires meet the road.

Sometimes, as when you are driving on snow or ice, it is easy to ask more of those control systems than the tires and road can provide. That means you can lose control of your vehicle.

Adding non-GM accessories can affect your vehicle's performance. See *Accessories and Modifications on page 382*.

## Braking

See *Brake System Warning Light on page 204*.

Braking action involves perception time and reaction time.

First, you have to decide to push on the brake pedal. That is perception time. Then you have to bring up your foot and do it. That is reaction time.

Average reaction time is about three-fourths of a second. But that is only an average. It might be less with one driver and as long as two or three seconds or more with another. Age, physical condition, alertness, coordination, and eyesight all play a part. So do alcohol, drugs, and frustration. But even in three-fourths of a second, a vehicle moving at 60 mph (100 km/h) travels 66 feet (20 m). That could be a lot of distance in an emergency, so keeping enough space between your vehicle and others is important.

And, of course, actual stopping distances vary greatly with the surface of the road, whether it is pavement or gravel; the condition of the road, whether it is wet, dry, or icy; tire tread; the condition of the brakes; the weight of the vehicle; and the amount of brake force applied.



Avoid needless heavy braking. Some people drive in spurts — heavy acceleration followed by heavy braking — rather than keeping pace with traffic. This is a mistake. The brakes may not have time to cool between hard stops. The brakes will wear out much faster if you do a lot of heavy braking. If you keep pace with the traffic and allow realistic following distances, you will eliminate a lot of unnecessary braking. That means better braking and longer brake life.

If your vehicle's engine ever stops while you are driving, brake normally but do not pump the brakes. If you do, the pedal may get harder to push down. If the engine stops, you will still have some power brake assist. But you will use it when you brake. Once the power assist is used up, it may take longer to stop and the brake pedal will be harder to push.

Adding non-GM accessories can affect your vehicle's performance. See *Accessories and Modifications on page 382*.

## Anti-Lock Brake System (ABS)

Your vehicle has the Anti-Lock Brake System (ABS), an advanced electronic braking system that will help prevent a braking skid.

When you start your engine and begin to drive away, ABS will check itself. You may hear a momentary motor or clicking noise while this test is going on. This is normal.

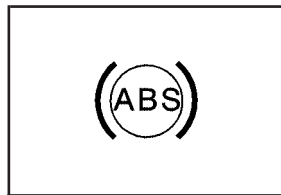

If there is a problem with ABS, this warning light will stay on. See *Anti-Lock Brake System Warning Light on page 205*.

Along with ABS, your vehicle has a Dynamic Rear Proportioning (DRP) system. If there is a DRP problem, both the brake and ABS warning lights will come on accompanied by a 10-second chime. The lights and chime will come on each time the ignition is turned on until the problem is repaired. See your dealer for service.

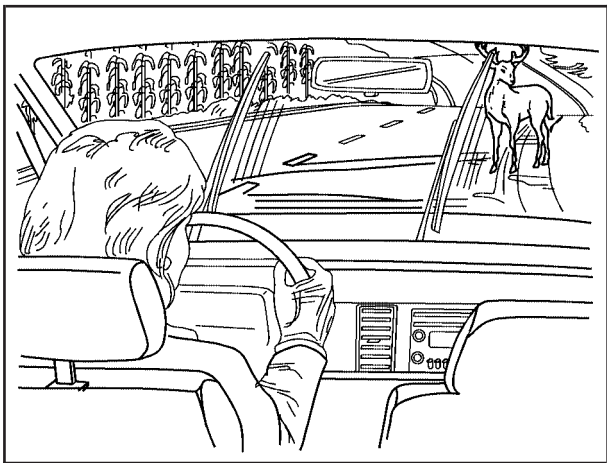

Let us say the road is wet and you are driving safely. Suddenly, an animal jumps out in front of you. You slam on the brakes and continue braking. Here is what happens with ABS:

A computer senses that wheels are slowing down. If one of the wheels is about to stop rolling, the computer will separately work the brakes at each front wheel and at both rear wheels.

ABS can change the brake pressure faster than any driver could. The computer is programmed to make the most of available tire and road conditions. This can help you steer around the obstacle while braking hard.



As you brake, your computer keeps receiving updates on wheel speed and controls braking pressure accordingly.

Remember: ABS does not change the time you need to get your foot up to the brake pedal or always decrease stopping distance. If you get too close to the vehicle in front of you, you will not have time to apply your brakes if that vehicle suddenly slows or stops. Always leave enough room up ahead to stop, even though you have ABS.

### **Using ABS**

Do not pump the brakes. Just hold the brake pedal down firmly and let anti-lock work for you. You may feel the brakes vibrate, or you may notice some noise, but this is normal.

### **Braking in Emergencies**

With ABS, you can steer and brake at the same time. In many emergencies, steering can help you more than even the very best braking.

### **Locking Rear Axle**

If your vehicle has this feature, your locking rear axle can give you additional traction on snow, mud, ice, sand or gravel. It works like a standard axle most of the time, but when one of the rear wheels has no traction and the other does, this feature will allow the wheel with traction to move the vehicle.

## **StabiliTrak® System**

Your vehicle is equipped with StabiliTrak®, Electronic Stability Control (ESC) which combines antilock brake, traction and stability control systems and helps the driver maintain directional control of the vehicle in most driving conditions.

Traction control activates when the controller senses wheel spin. StabiliTrak® will selectively apply the brakes and reduce engine torque to help regain traction.

Stability control activates when the controller senses a discrepancy between your intended path and the direction the vehicle is travelling. StabiliTrak® selectively applies braking pressure at any one of the vehicle's brakes to help guide the vehicle in the direction which you are steering.

When you first start your vehicle and begin to drive away, the system performs several diagnostic checks to insure there are no problems. You may hear or feel the system working. This is normal and does not mean there is a problem with your vehicle. If driving conditions delay system initialization, the STABILITRAK NOT READY message may be displayed. If this is the case, your vehicle does not need servicing.

For more information on the stability messages, see *DIC Warnings and Messages on page 220*.



When the StabiliTrak<sup>®</sup> system is both on and actively controlling the stability of the vehicle, the StabiliTrak<sup>®</sup> light will blink for the duration of the event.

You may also feel or hear the system working. This is normal.



The StabiliTrak<sup>®</sup> disable button is located on the transmission shift handle.

For vehicles with four-wheel drive, the StabiliTrak<sup>®</sup> system is automatically disabled in 4LO mode and cannot be turned on until the vehicle is switched to 2HI, 4HI, or 4AWD.

The StabiliTrak<sup>®</sup> system has three modes of operation: STABILITRAK ON, TRACTION CONTROL OFF, and STABILITRAK OFF.

**STABILITRAK ON** - The vehicle will default to STABILITRAK ON every time the driver starts the vehicle. The StabiliTrak<sup>®</sup> light will be off and no DIC messages will be displayed.

**TRACTION CONTROL OFF** - The driver can modify the engine speed management system by momentarily pressing the StabiliTrak<sup>®</sup> button on the transmission shift handle. The StabiliTrak<sup>®</sup> light will come on and TRACTION CONTROL OFF will be displayed. For vehicles without a DIC, the StabiliTrak<sup>®</sup> indicator light will come on. Momentarily pressing the StabiliTrak<sup>®</sup> button again will return the system to the STABILITRAK ON mode.

**STABILITRAK OFF** - The driver can turn off StabiliTrak<sup>®</sup> by pressing the StabiliTrak<sup>®</sup> button for more than five seconds. The StabiliTrak<sup>®</sup> light will come on and STABILITRAK OFF will be displayed. For vehicles without a DIC, the StabiliTrak<sup>®</sup> indicator light will come on. Momentarily pressing the StabiliTrak<sup>®</sup> button again will return the system to the STABILITRAK ON mode. See StabiliTrak<sup>®</sup> Off below for more information.

## Traction Control Off

In this mode, stability control and brake-traction control are functional. Engine speed management will be modified and the driven wheels can spin more freely. This can cause the brake-traction control to activate more frequently. If the controller detects excessive wheel spin in this mode, the StabiliTrak<sup>®</sup> indicator light may blink and the STABILITRAK ACTIVE message may be displayed to warn the driver that damage may occur to the transfer case.

## StabiliTrak<sup>®</sup> Off

In this mode, both stability control and part of the traction control system are disabled. Your vehicle will still have brake-traction control, but will not be able to use the engine speed management system. You may still hear system noises as a result of the brake-traction control coming on. If the controller detects excessive wheel spin in this mode, the StabiliTrak<sup>®</sup> indicator light may blink and the STABILITRAK ACTIVE message may be displayed to warn the driver that damage may occur to the transfer case.

It is recommended to leave the system on for normal driving conditions, but it may be necessary to turn the system off if your vehicle is stuck in sand, mud, ice or snow, and you may want to “rock” your vehicle in an attempt to free it. It may also be necessary to turn off the system when driving in extreme off-road conditions where high wheel spin is required. See *If Your Vehicle is Stuck in Sand, Mud, Ice, or Snow* on page 348 for more information.

For vehicles with four-wheel drive, when the transfer case is in 4LO, the stability system is automatically disabled. The StabiliTrak<sup>®</sup> light will come on and the STABILITRAK OFF message will appear on the DIC. The StabiliTrak<sup>®</sup> system cannot be turned on until the vehicle is switched to 2HI, 4HI, or 4AWD.

The following chart describes the StabiliTrak<sup>®</sup> system events and the corresponding messages and lights that will be displayed on the instrument panel cluster.

Vehicles with a DIC		Vehicles without a DIC		Event
StabiliTrak <sup>®</sup> Indicator Light	DIC Message	StabiliTrak <sup>®</sup> Indicator Light	StabiliTrak <sup>®</sup> Service Light	
Off	None	Off	Off	StabiliTrak <sup>®</sup> On mode (System is fully enabled, but is not actively controlling vehicle stability).
Solid	Traction Control Off	Solid	Off	Traction Control Off Mode
Solid	StabiliTrak <sup>®</sup> Off	Solid	Off	StabiliTrak <sup>®</sup> Off Mode (StabiliTrak <sup>®</sup> indicator light will flash when system first enters this mode).
Blinking	StabiliTrak <sup>®</sup> Active	Blinking	Off	StabiliTrak <sup>®</sup> system activates using engine speed management, brake traction control, and/or stability control.
Solid	Service StabiliTrak <sup>®</sup>	Solid	Solid	StabiliTrak <sup>®</sup> system is disabled due to a system fault.
Solid	StabiliTrak <sup>®</sup> Not Ready	Solid	Off	StabiliTrak <sup>®</sup> system is disabled due to a failure to initialize.

**Notice:** If the StabiliTrak® light comes on due to heavy braking and/or because the traction control system has been continuously active, do not allow the wheel(s) of one axle to spin excessively. If you do, you may be causing damage to the transfer case. This could lead to costly repairs not covered by your warranty.

**Notice:** If you allow the wheel(s) of one axle to spin excessively while the StabiliTrak®, ABS and brake warning lights and the SERVICE STABILITRAK message are displayed, you could damage the transfer case. The repairs would not be covered by your warranty. Reduce engine power and do not spin the wheel(s) excessively while these lights and this message are displayed.

StabiliTrak® may activate on dry or rough roads or under conditions such as heavy acceleration while turning or abrupt upshifts/downshifts of the transmission. When this happens, you may notice a reduction in acceleration, or may hear a noise or vibration. This is normal.

If your vehicle is in cruise control when the system activates, the StabiliTrak® light will blink, and the cruise control will automatically disengage.

When road conditions allow, you may re-engage the cruise control. See *Cruise Control on page 174*.

StabiliTrak® will turn off automatically if a problem is detected in the system. The StabiliTrak® light will come on and SERVICE STABILITRAK will be displayed on the DIC. For vehicles without a DIC, the StabiliTrak® light and the StabiliTrak® service light will both come on. If the SERVICE STABILITRAK message (or StabiliTrak® service light) does not clear itself after restarting the vehicle, you should see your dealer for service.

Adding non-GM accessories can affect your vehicle's performance. See *Accessories and Modifications on page 382* for more information.

## All-Wheel Drive (AWD) System (TrailBlazer SS)

If your vehicle has this feature, engine power is sent to all four wheels all the time.

This is like four-wheel drive, but there is no separate lever or switch to engage or disengage the front axle. It is fully automatic, and adjusts itself as needed for road conditions.

# Steering

## Power Steering

If you lose power steering assist because the engine stops or the system is not functioning, you can steer but it will take much more effort.

## Steering Tips

It is important to take curves at a reasonable speed.

A lot of the “driver lost control” accidents mentioned on the news happen on curves. Here is why:

Experienced driver or beginner, each of us is subject to the same laws of physics when driving on curves. The traction of the tires against the road surface makes it possible for the vehicle to change its path when you turn the front wheels. If there is no traction, inertia will keep the vehicle going in the same direction. If you have ever tried to steer a vehicle on wet ice, you will understand this.

The traction you can get in a curve depends on the condition of your tires and the road surface, the angle at which the curve is banked, and your speed. While you are in a curve, speed is the one factor you can control.

Suppose you are steering through a sharp curve. Then you suddenly accelerate. Both control systems — steering and acceleration — have to do their work where the tires meet the road. Adding the sudden acceleration can demand too much of those places. You can lose control.

What should you do if this ever happens? Ease up on the accelerator pedal, steer the vehicle the way you want it to go, and slow down.

Speed limit signs near curves warn that you should adjust your speed. Of course, the posted speeds are based on good weather and road conditions. Under less favorable conditions you will want to go slower.

If you need to reduce your speed as you approach a curve, do it before you enter the curve, while your front wheels are straight ahead.

Try to adjust your speed so you can “drive” through the curve. Maintain a reasonable, steady speed. Wait to accelerate until you are out of the curve, and then accelerate gently into the straightaway.

Adding non-GM accessories can affect your vehicle’s performance. See *Accessories and Modifications on page 382*.



## Steering in Emergencies

There are times when steering can be more effective than braking. For example, you come over a hill and find a truck stopped in your lane, or a car suddenly pulls out from nowhere, or a child darts out from between parked cars and stops right in front of you. You can avoid these problems by braking — if you can stop in time. But sometimes you cannot; there is not room. That is the time for evasive action — steering around the problem.

Your vehicle can perform very well in emergencies like these. First apply your brakes.

See *Braking on page 304*. It is better to remove as much speed as you can from a possible collision. Then steer around the problem, to the left or right depending on the space available.

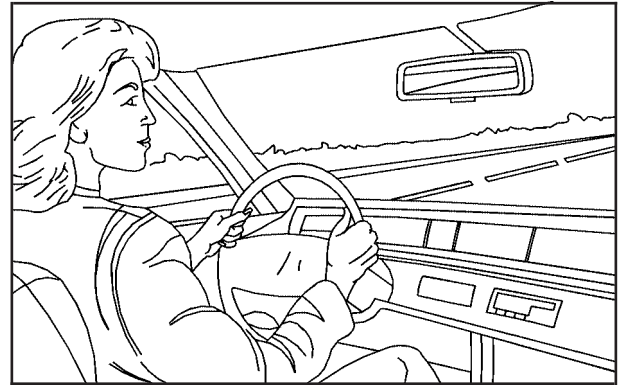

An emergency like this requires close attention and a quick decision. If you are holding the steering wheel at the recommended 9 and 3 o'clock positions, you can turn it a full 180 degrees very quickly without removing either hand. But you have to act fast, steer quickly, and just as quickly straighten the wheel once you have avoided the object.

The fact that such emergency situations are always possible is a good reason to practice defensive driving at all times and wear safety belts properly.

## Off-Road Recovery

You may find that your right wheels have dropped off the edge of a road onto the shoulder while you are driving.

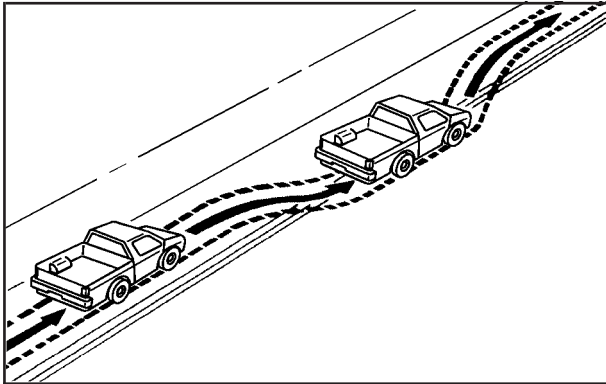

If the level of the shoulder is only slightly below the pavement, recovery should be fairly easy. Ease off the accelerator and then, if there is nothing in the way, steer so that your vehicle straddles the edge of the pavement. You can turn the steering wheel up to one-quarter turn until the right front tire contacts the pavement edge. Then turn your steering wheel to go straight down the roadway.

## Passing

The driver of a vehicle about to pass another on a two-lane highway waits for just the right moment, accelerates, moves around the vehicle ahead, then goes back into the right lane again. A simple maneuver?

Not necessarily! Passing another vehicle on a two-lane highway is a potentially dangerous move, since the passing vehicle occupies the same lane as oncoming traffic for several seconds. A miscalculation, an error in judgment, or a brief surrender to frustration or anger can suddenly put the passing driver face to face with the worst of all traffic accidents — the head-on collision.

So here are some tips for passing:

- Drive ahead. Look down the road, to the sides, and to crossroads for situations that might affect your passing patterns. If you have any doubt whatsoever about making a successful pass, wait for a better time.

- Watch for traffic signs, pavement markings, and lines. If you can see a sign up ahead that might indicate a turn or an intersection, delay your pass. A broken center line usually indicates it is all right to pass, providing the road ahead is clear. Never cross a solid line on your side of the lane or a double solid line, even if the road seems empty of approaching traffic.
- Do not get too close to the vehicle you want to pass while you are awaiting an opportunity. For one thing, following too closely reduces your area of vision, especially if you are following a larger vehicle. Also, you will not have adequate space if the vehicle ahead suddenly slows or stops. Keep back a reasonable distance.
- When it looks like a chance to pass is coming up, start to accelerate but stay in the right lane and do not get too close. Time your move so you will be increasing speed as the time comes to move into the other lane. If the way is clear to pass, you will have a running start that more than makes up for the distance you would lose by dropping back. And if something happens to cause you to cancel your pass, you need only slow down and drop back again and wait for another opportunity.
- If other vehicles are lined up to pass a slow vehicle, wait your turn. But take care that someone is not trying to pass you as you pull out to pass the slow vehicle. Remember to glance over your shoulder and check the blind spot.
- Check your vehicle's mirrors, glance over your shoulder, and start your left lane change signal before moving out of the right lane to pass. When you are far enough ahead of the passed vehicle to see its front in your vehicle's inside mirror, activate the right lane change signal and move back into the right lane. Remember that your vehicle's passenger side outside mirror is convex. The vehicle you just passed may seem to be farther away from you than it really is.
- Try not to pass more than one vehicle at a time on two-lane roads. Reconsider before passing the next vehicle.
- Do not overtake a slowly moving vehicle too rapidly. Even though the brake lamps are not flashing, it may be slowing down or starting to turn.
- If you are being passed, make it easy for the following driver to get ahead of you. Perhaps you can ease a little to the right.

## Loss of Control

Let us review what driving experts say about what happens when the three control systems — brakes, steering, and acceleration — do not have enough friction where the tires meet the road to do what the driver has asked.

In any emergency, do not give up. Keep trying to steer and constantly seek an escape route or area of less danger.

## Skidding

In a skid, a driver can lose control of the vehicle. Defensive drivers avoid most skids by taking reasonable care suited to existing conditions, and by not overdriving those conditions. But skids are always possible.

The three types of skids correspond to your vehicle's three control systems. In the braking skid, your wheels are not rolling. In the steering or cornering skid, too much speed or steering in a curve causes tires to slip and lose cornering force. And in the acceleration skid, too much throttle causes the driving wheels to spin.

A cornering skid is best handled by easing your foot off the accelerator pedal.

If your vehicle starts to slide, ease your foot off the accelerator pedal and quickly steer the way you want the vehicle to go. If you start steering quickly enough, your vehicle may straighten out. Always be ready for a second skid if it occurs.

Of course, traction is reduced when water, snow, ice, gravel, or other material is on the road. For safety, you will want to slow down and adjust your driving to these conditions. It is important to slow down on slippery surfaces because stopping distance will be longer and vehicle control more limited.

While driving on a surface with reduced traction, try your best to avoid sudden steering, acceleration, or braking, including reducing vehicle speed by shifting to a lower gear. Any sudden changes could cause the tires to slide. You may not realize the surface is slippery until your vehicle is skidding. Learn to recognize warning clues — such as enough water, ice, or packed snow on the road to make a mirrored surface — and slow down when you have any doubt.

Remember: Any Anti-Lock Brake System (ABS) helps avoid only the braking skid.

## Competitive Driving

See your warranty book before using your vehicle for competitive driving. After reviewing your warranty book, please see the GM Performance Parts website or catalog for parts and equipment required for competitive driving.

**Notice:** If you use your vehicle for competitive driving, the engine may use more oil than it would with normal use. Low oil levels can damage the engine. Be sure to check the oil level often during competitive driving and keep the level at or near the upper mark that shows the proper operating range on the engine oil dipstick. For information on how to add oil, see *Engine Oil on page 398*.

## Off-Road Driving (Except SS)

This off-road guide is for vehicles that have four-wheel drive. Also, see *Braking on page 304*. If your vehicle does not have four-wheel drive, you should not drive off-road unless you are on a level, solid surface.

Off-road driving can be great fun. But it does have some definite hazards. The greatest of these is the terrain itself.

“Off-roading” means you have left the great North American road system behind. Traffic lanes are not marked. Curves are not banked. There are no road signs. Surfaces can be slippery, rough, uphill, or downhill. In short, you have gone right back to nature.

Off-road driving involves some new skills. And that is why it is very important that you read this guide. You will find many driving tips and suggestions. These will help make your off-road driving safer and more enjoyable.

## Before You Go Off-Roading

There are some things to do before you go out. For example, be sure to have all necessary maintenance and service work done. Check to make sure all underbody shields, if the vehicle has them, are properly attached.

Be sure you read all the information about your four-wheel-drive vehicle in this manual.

Is there enough fuel? Is the spare tire fully inflated? Are the fluid levels up where they should be? What are the local laws that apply to off-roading where you will be driving? If you do not know, you should check with law enforcement people in the area. Will you be on someone's private land? If so, be sure to get the necessary permission.

## Loading Your Vehicle for Off-Road Driving

### CAUTION:

- **Cargo on the load floor piled higher than the seatbacks can be thrown forward during a sudden stop. You or your passengers could be injured. Keep cargo below the top of the seatbacks.**
- **Unsecured cargo on the load floor can be tossed about when driving over rough terrain. You or your passengers can be struck by flying objects. Secure the cargo properly.**
- **Heavy loads on the roof raise the vehicle's center of gravity, making it more likely to roll over. You can be seriously or fatally injured if the vehicle rolls over. Put heavy loads inside the cargo area, not on the roof. Keep cargo in the cargo area as far forward and low as possible.**

There are some important things to remember about how to load your vehicle.

- The heaviest things should be on the load floor and forward of the rear axle. Put heavier items as far forward as you can.
- Be sure the load is secured properly, so driving on the off-road terrain does not toss things around.

You will find other important information in this manual. See *Loading Your Vehicle* on page 350, *Luggage Carrier* on page 161, and *Tires* on page 443.

## Environmental Concerns

Off-road driving can provide wholesome and satisfying recreation. However, it also raises environmental concerns. We recognize these concerns and urge every off-roader to follow these basic rules for protecting the environment:

- Always use established trails, roads, and areas that have been specially set aside for public off-road recreational driving; obey all posted regulations.
- Avoid any driving practice that could damage the environment — shrubs, flowers, trees, grasses — or disturb wildlife. This includes wheel-spinning, breaking down trees, or unnecessary driving through streams or over soft ground.
- Always carry a litter bag — make sure all refuse is removed from any campsite before leaving.
- Take extreme care with open fires where permitted, camp stoves, and lanterns.
- Never park your vehicle over dry grass or other combustible materials that could catch fire from the heat of the vehicle's exhaust system.

## Traveling to Remote Areas

It makes sense to plan your trip, especially when going to a remote area. Know the terrain and plan your route. You are much less likely to get bad surprises. Get accurate maps of trails and terrain. Try to learn of any blocked or closed roads.

It is also a good idea to travel with at least one other vehicle. If something happens to one of them, the other can help quickly.

Does your vehicle have a winch? If so, be sure to read the winch instructions. In a remote area, a winch can be handy if you get stuck. But you will want to know how to use it properly.

## Getting Familiar with Off-Road Driving

It is a good idea to practice in an area that is safe and close to home before you go into the wilderness. Off-road driving does require some new and different skills. Here is what we mean.

Tune your senses to different kinds of signals. Your eyes, for example, need to constantly sweep the terrain for unexpected obstacles. Your ears need to listen for unusual tire or engine sounds. With your arms, hands, feet, and body, you will need to respond to vibrations and vehicle bounce.

Controlling your vehicle is the key to successful off-road driving. One of the best ways to control your vehicle is to control your speed. Here are some things to keep in mind. At higher speeds:

- You approach things faster and you have less time to scan the terrain for obstacles.
- You have less time to react.
- You have more vehicle bounce when you drive over obstacles.
- You will need more distance for braking, especially since you are on an unpaved surface.

### CAUTION:

**When you are driving off-road, bouncing and quick changes in direction can easily throw you out of position. This could cause you to lose control and crash. So, whether you are driving on or off the road, you and your passengers should wear safety belts.**



## Scanning the Terrain

Off-road driving can take you over many different kinds of terrain. You need to be familiar with the terrain and its many different features. Here are some things to consider.

**Surface Conditions:** Off-roading can take you over hard-packed dirt, gravel, rocks, grass, sand, mud, snow, or ice. Each of these surfaces affects the steering, acceleration, and braking of your vehicle in different ways. Depending upon the kind of surface you are on, you may experience slipping, sliding, wheel spinning, delayed acceleration, poor traction, and longer braking distances.

**Surface Obstacles:** Unseen or hidden obstacles can be hazardous. A rock, log, hole, rut, or bump can startle you if you are not prepared for them. Often these obstacles are hidden by grass, bushes, snow, or even the rise and fall of the terrain itself. Here are some things to consider:

- Is the path ahead clear?
- Will the surface texture change abruptly up ahead?
- Does the travel take you uphill or downhill? There is more discussion of these subjects later.
- Will you have to stop suddenly or change direction quickly?

When you drive over obstacles or rough terrain, keep a firm grip on the steering wheel. Ruts, troughs, or other surface features can jerk the wheel out of your hands if you are not prepared.

When you drive over bumps, rocks, or other obstacles, the wheels can leave the ground. If this happens, even with one or two wheels, you cannot control the vehicle as well or at all.

Because you will be on an unpaved surface, it is especially important to avoid sudden acceleration, sudden turns, or sudden braking.

In a way, off-road driving requires a different kind of alertness from driving on paved roads and highways. There are no road signs, posted speed limits, or signal lights. You have to use your own good judgment about what is safe and what is not.

Drinking and driving can be very dangerous on any road. And this is certainly true for off-road driving. At the very time you need special alertness and driving skills, your reflexes, perceptions, and judgment can be affected by even a small amount of alcohol. You could have a serious — or even fatal — accident if you drink and drive or ride with a driver who has been drinking. See *Drunken Driving on page 301*.

## Driving on Off-Road Hills

Off-road driving often takes you up, down, or across a hill. Driving safely on hills requires good judgment and an understanding of what your vehicle can and cannot do. There are some hills that simply cannot be driven, no matter how well built the vehicle.

### CAUTION:

**Many hills are simply too steep for any vehicle. If you drive up them, you will stall. If you drive down them, you cannot control your speed. If you drive across them, you will roll over. You could be seriously injured or killed. If you have any doubt about the steepness, do not drive the hill.**

## Approaching a Hill

When you approach a hill, you need to decide if it is one of those hills that is just too steep to climb, descend, or cross. Steepness can be hard to judge. On a very small hill, for example, there may be a smooth, constant incline with only a small change in elevation where you can easily see all the way to the top. On a large hill, the incline may get steeper as you near the top, but you may not see this because the crest of the hill is hidden by bushes, grass, or shrubs.

Here are some other things to consider as you approach a hill.

- Is there a constant incline, or does the hill get sharply steeper in places?
- Is there good traction on the hillside, or will the surface cause tire slipping?
- Is there a straight path up or down the hill so you will not have to make turning maneuvers?
- Are there obstructions on the hill that can block your path, such as boulders, trees, logs, or ruts?
- What is beyond the hill? Is there a cliff, an embankment, a drop-off, a fence? Get out and walk the hill if you do not know. It is the smart way to find out.
- Is the hill simply too rough? Steep hills often have ruts, gullies, troughs, and exposed rocks because they are more susceptible to the effects of erosion.

## Driving Uphill

Once you decide you can safely drive up the hill, you need to take some special steps.

- Use a low gear and get a firm grip on the steering wheel.
- Get a smooth start up the hill and try to maintain your speed. Do not use more power than you need, because you do not want the wheels to start spinning or sliding.
- Try to drive straight up the hill if at all possible. If the path twists and turns, you might want to find another route.

### CAUTION:

**Turning or driving across steep hills can be dangerous. You could lose traction, slide sideways, and possibly roll over. You could be seriously injured or killed. When driving up hills, always try to go straight up.**

- Ease up on your speed as you approach the top of the hill.
- Attach a flag to the vehicle to make you more visible to approaching traffic on trails or hills.
- Sound the horn as you approach the top of the hill to let opposing traffic know you are there.
- Use your headlamps even during the day. They make you more visible to oncoming traffic.

### CAUTION:

**Driving to the top (crest) of a hill at full speed can cause an accident. There could be a drop-off, embankment, cliff, or even another vehicle. You could be seriously injured or killed. As you near the top of a hill, slow down and stay alert.**

**Q: What should I do if my vehicle stalls, or is about to stall, and I cannot make it up the hill?**

**A:** If this happens, there are some things you should do, and there are some things you must not do. First, here is what you *should* do:

- Push the brake pedal to stop the vehicle and keep it from rolling backwards. Also, apply the parking brake.
- If the engine is still running, shift the transmission to REVERSE (R), release the parking brake, and slowly back down the hill in REVERSE (R).
- If the engine has stopped running, you will need to restart it. With the brake pedal pressed and the parking brake still applied, shift the transmission to PARK (P) and restart the engine. Then, shift to REVERSE (R), release the parking brake, and slowly back down the hill as straight as possible in REVERSE (R).

- As you are backing down the hill, put your left hand on the steering wheel at the 12 o'clock position. This way, you will be able to tell if the wheels are straight and maneuver as you back down. It is best that you back down the hill with the wheels straight rather than in the left or right direction. Turning the wheel too far to the left or right will increase the possibility of a rollover.

Here are some things you *must not* do if you stall, or are about to stall, when going up a hill.

- Never attempt to prevent a stall by shifting into NEUTRAL (N) to rev-up the engine and regain forward momentum. This will not work. Your vehicle will roll backwards very quickly and you could go out of control. Instead, apply the regular brake to stop the vehicle. Then apply the parking brake. Shift to REVERSE (R), release the parking brake, and slowly back straight down.
- Never attempt to turn around if you are about to stall when going up a hill. If the hill is steep enough to stall your vehicle, it is steep enough to cause you to roll over if you turn around. If you cannot make it up the hill, you must back straight down the hill.

**Q:** Suppose, after stalling, I try to back down the hill and decide I just cannot do it. What should I do?

**A:** Set the parking brake, put the transmission in PARK (P) and turn off the engine. Leave the vehicle and go get some help. Exit on the uphill side and stay clear of the path the vehicle would take if it rolled downhill. Do not shift the transfer case to NEUTRAL when you leave the vehicle. Leave it in some gear.

 **CAUTION:**

**Shifting the transfer case to NEUTRAL can cause your vehicle to roll even if the transmission is in PARK (P). This is because the NEUTRAL position on the transfer case overrides the transmission. You or someone else could be injured. If you are going to leave your vehicle, set the parking brake and shift the transmission to PARK (P). But do not shift the transfer case to NEUTRAL. Leave the transfer case in the Two-Wheel High, Four-Wheel High or Four-Wheel Low position.**

## Driving Downhill

When off-roading takes you downhill, you will want to consider a number of things:

- How steep is the downhill? Will I be able to maintain vehicle control?
- What is the surface like? Smooth? Rough? Slippery? Hard-packed dirt? Gravel?
- Are there hidden surface obstacles? Ruts? Logs? Boulders?
- What is at the bottom of the hill? Is there a hidden creek bank or even a river bottom with large rocks?

If you decide you can go down a hill safely, then try to keep your vehicle headed straight down, and use a low gear. This way, engine drag can help the brakes and they will not have to do all the work. Descend slowly, keeping your vehicle under control at all times.

### CAUTION:

**Heavy braking when going down a hill can cause your brakes to overheat and fade. This could cause loss of control and a serious accident. Apply the brakes lightly when descending a hill and use a low gear to keep vehicle speed under control.**

**Q: Are there some things I should not do when driving down a hill?**

**A:** Yes! These are important because if you ignore them you could lose control and have a serious accident.

- When driving downhill, avoid turns that take you across the incline of the hill. A hill that is not too steep to drive down may be too steep to drive across. You could roll over if you do not drive straight down.
- Never go downhill with the transmission in NEUTRAL (N). This is called “free-wheeling.” The brakes will have to do all the work and could overheat and fade.

**Q: Am I likely to stall when going downhill?**

**A:** It is much more likely to happen going uphill. But if it happens going downhill, here is what to do.

1. Stop your vehicle by applying the regular brakes. Apply the parking brake.
2. Shift to PARK (P) and, while still braking, restart the engine.
3. Shift back to a low gear, release the parking brake, and drive straight down.
4. If the engine will not start, get out and get help.



## Driving Across an Incline

Sooner or later, an off-road trail will probably go across the incline of a hill. If this happens, you have to decide whether to try to drive across the incline. Here are some things to consider:

- A hill that can be driven straight up or down may be too steep to drive across. When you go straight up or down a hill, the length of the wheel base — the distance from the front wheels to the rear wheels — reduces the likelihood the vehicle will tumble end over end. But when you drive across an incline, the much more narrow track width — the distance between the left and right wheels — may not prevent the vehicle from tilting and rolling over. Also, driving across an incline puts more weight on the downhill wheels. This could cause a downhill slide or a rollover.
- Surface conditions can be a problem when you drive across a hill. Loose gravel, muddy spots, or even wet grass can cause the tires to slip sideways, downhill. If the vehicle slips sideways, it can hit something that will trip it — a rock, a rut, etc. — and roll over.

- Hidden obstacles can make the steepness of the incline even worse. If you drive across a rock with the uphill wheels, or if the downhill wheels drop into a rut or depression, your vehicle can tilt even more.

For reasons like these, you need to decide carefully whether to try to drive across an incline. Just because the trail goes across the incline does not mean you have to drive it. The last vehicle to try it might have rolled over.

### CAUTION:

**Driving across an incline that is too steep will make your vehicle roll over. You could be seriously injured or killed. If you have any doubt about the steepness of the incline, do not drive across it. Find another route instead.**

**Q:** What if I am driving across an incline that is not too steep, but I hit some loose gravel and start to slide downhill. What should I do?

**A:** If you feel your vehicle starting to slide sideways, turn downhill. This should help straighten out the vehicle and prevent the side slipping. However, a much better way to prevent this is to get out and “walk the course” so you know what the surface is like before you drive it.

## Stalling on an Incline

If your vehicle stalls when you are crossing an incline, be sure you, and any passengers, get out on the uphill side, even if the door there is harder to open. If you get out on the downhill side and the vehicle starts to roll over, you will be right in its path.

If you have to walk down the slope, stay out of the path the vehicle will take if it does roll over.

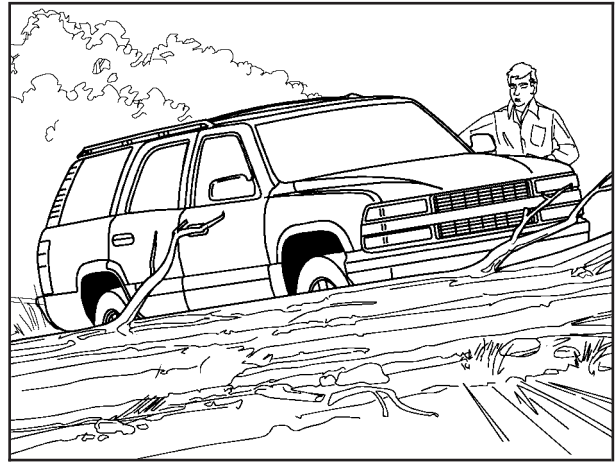

### CAUTION:

**Getting out on the downhill (low) side of a vehicle stopped across an incline is dangerous. If the vehicle rolls over, you could be crushed or killed. Always get out on the uphill (high) side of the vehicle and stay well clear of the rollover path.**

## Driving in Mud, Sand, Snow, or Ice

When you drive in mud, snow, or sand, the wheels will not get good traction. You cannot accelerate as quickly, turning is more difficult, and you will need longer braking distances.

It is best to use a low gear when you are in mud — the deeper the mud, the lower the gear. In really deep mud, the idea is to keep your vehicle moving so you do not get stuck.

When you drive on sand, you will sense a change in wheel traction. But it will depend upon how loosely packed the sand is. On loosely packed sand, such as on beaches or sand dunes, the tires will tend to sink into the sand. This has an effect on steering, accelerating, and braking. Drive at a reduced speed and avoid sharp turns or abrupt maneuvers.

Hard packed snow and ice offer the worst tire traction. On these surfaces, it is very easy to lose control. On wet ice, for example, the traction is so poor that you will have difficulty accelerating. And if you do get moving, poor steering and difficult braking can cause you to slide out of control.

### CAUTION:

**Driving on frozen lakes, ponds, or rivers can be dangerous. Underwater springs, currents under the ice, or sudden thaws can weaken the ice. Your vehicle could fall through the ice and you and your passengers could drown. Drive your vehicle on safe surfaces only.**

## Driving in Water

Heavy rain can mean flash flooding, and flood waters demand extreme caution.

Find out how deep the water is before you drive through it. If it is deep enough to cover the wheel hubs, axles, or exhaust pipe, do not try it — you probably will not get through. Also, water that deep can damage the axle and other vehicle parts.

If the water is not too deep, drive slowly through it. At faster speeds, water splashes on the ignition system and your vehicle can stall. Stalling can also occur if you get the tailpipe under water. And, as long as the tailpipe is under water, you will never be able to start the engine. When you go through water, remember that when the brakes get wet, it may take you longer to stop.

### CAUTION:

**Driving through rushing water can be dangerous. Deep water can sweep your vehicle downstream and you and your passengers could drown. If it is only shallow water, it can still wash away the ground from under your tires, and you could lose traction and roll the vehicle over. Do not drive through rushing water.**

See *Driving in Rain and on Wet Roads* on page 334 for more information on driving through water.

## After Off-Road Driving

Remove any brush or debris that has collected on the underbody, chassis, or under the hood. These accumulations can be a fire hazard.

After operation in mud or sand, have the brake linings cleaned and checked. These substances can cause glazing and uneven braking. Check the body structure, steering, suspension, wheels, tires, and exhaust system for damage. Also, check the fuel lines and cooling system for any leakage.

Your vehicle will require more frequent service due to off-road use. Refer to the Maintenance Schedule for additional information.

## Driving at Night

Night driving is more dangerous than day driving. One reason is that some drivers are likely to be impaired — by alcohol or drugs, with night vision problems, or by fatigue.

Here are some tips on night driving.

- Drive defensively.
- Do not drink and drive.

- Adjust the inside rearview mirror to reduce the glare from headlamps behind you.
- Since you cannot see as well, you may need to slow down and keep more space between you and other vehicles.
- Slow down, especially on higher speed roads. Your vehicle's headlamps can light up only so much road ahead.
- In remote areas, watch for animals.
- If you are tired, pull off the road in a safe place and rest.

No one can see as well at night as in the daytime. But as we get older these differences increase. A 50-year-old driver may require at least twice as much light to see the same thing at night as a 20-year-old.

What you do in the daytime can also affect your night vision. For example, if you spend the day in bright sunshine you are wise to wear sunglasses. Your eyes will have less trouble adjusting to night. But if you are driving, do not wear sunglasses at night. They may cut down on glare from headlamps, but they also make a lot of things invisible.

You can be temporarily blinded by approaching headlamps. It can take a second or two, or even several seconds, for your eyes to re-adjust to the dark. When you are faced with severe glare, as from a driver who does not lower the high beams, or a vehicle with misaimed headlamps, slow down a little. Avoid staring directly into the approaching headlamps.

Keep the windshield and all the glass on your vehicle clean — inside and out. Glare at night is made much worse by dirt on the glass. Even the inside of the glass can build up a film caused by dust. Dirty glass makes lights dazzle and flash more than clean glass would, making the pupils of your eyes contract repeatedly.

Remember that the headlamps light up far less of a roadway when you are in a turn or curve. Keep your eyes moving; that way, it is easier to pick out dimly lighted objects. Just as the headlamps should be checked regularly for proper aim, so should your eyes be examined regularly. Some drivers suffer from night blindness — the inability to see in dim light — and are not even aware of it.

## Driving in Rain and on Wet Roads

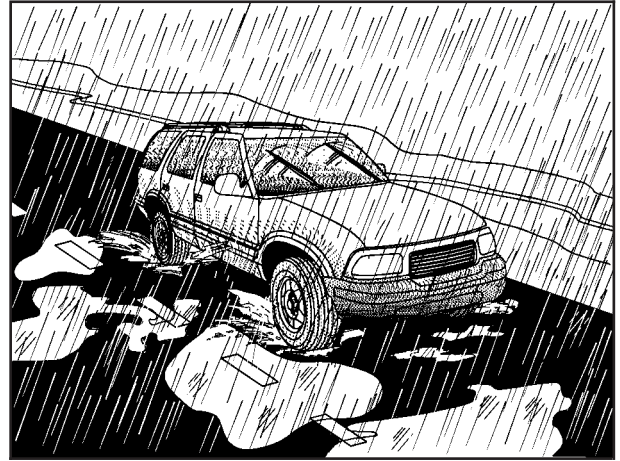

Rain and wet roads can mean driving trouble. On a wet road, you cannot stop, accelerate, or turn as well because your tire-to-road traction is not as good as on dry roads.

And, if your tires do not have much tread left, you will get even less traction. It is always wise to go slower and be cautious if rain starts to fall while you are driving. The surface may get wet suddenly when your reflexes are tuned for driving on dry pavement.

The heavier the rain, the harder it is to see. Even if your windshield wiper blades are in good shape, a heavy rain can make it harder to see road signs and traffic signals, pavement markings, the edge of the road, and even people walking.

It is wise to keep your wiping equipment in good shape and keep your windshield washer fluid reservoir filled with washer fluid. Replace your windshield wiper inserts when they show signs of streaking or missing areas on the windshield, or when strips of rubber start to separate from the inserts.

 **CAUTION:**

**Wet brakes can cause accidents. They may not work as well in a quick stop and may cause pulling to one side. You could lose control of the vehicle.**

**After driving through a large puddle of water or a car wash, apply your brake pedal lightly until your brakes work normally.**

Driving too fast through large water puddles or even going through some car washes can cause problems, too. The water may affect your brakes. Try to avoid puddles. But if you cannot, try to slow down before you hit them.

## Hydroplaning

Hydroplaning is dangerous. So much water can build up under your tires that they can actually ride on the water. This can happen if the road is wet enough and you are going fast enough. When your vehicle is hydroplaning, it has little or no contact with the road.

Hydroplaning does not happen often. But it can if your tires do not have much tread or if the pressure in one or more is low. It can happen if a lot of water is standing on the road. If you can see reflections from trees, telephone poles, or other vehicles, and raindrops dimple the water's surface, there could be hydroplaning.

Hydroplaning usually happens at higher speeds. There just is not a hard and fast rule about hydroplaning. The best advice is to slow down when it is raining.

## Driving Through Deep Standing Water

**Notice:** If you drive too quickly through deep puddles or standing water, water can come in through your engine's air intake and badly damage your engine. Never drive through water that is slightly lower than the underbody of your vehicle. If you cannot avoid deep puddles or standing water, drive through them very slowly.



## Driving Through Flowing Water

### CAUTION:

**Flowing or rushing water creates strong forces. If you try to drive through flowing water, as you might at a low water crossing, your vehicle can be carried away. As little as six inches of flowing water can carry away a smaller vehicle. If this happens, you and other vehicle occupants could drown. Do not ignore police warning signs, and otherwise be very cautious about trying to drive through flowing water.**

## Some Other Rainy Weather Tips

- Besides slowing down, allow some extra following distance. And be especially careful when you pass another vehicle. Allow yourself more clear room ahead, and be prepared to have your view restricted by road spray.
- Have good tires with proper tread depth. See *Tires* on page 443.

## City Driving

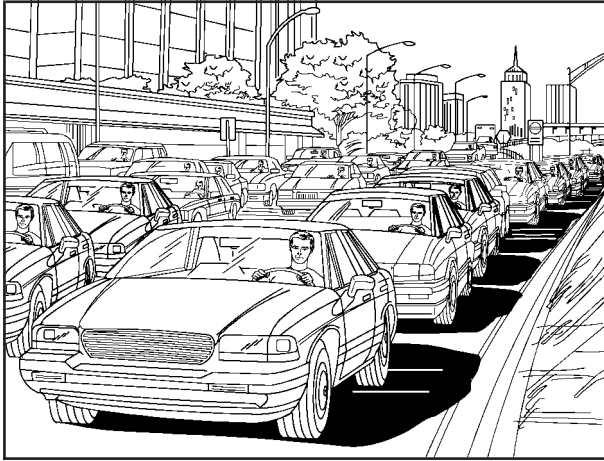

One of the biggest problems with city streets is the amount of traffic on them. You will want to watch out for what the other drivers are doing and pay attention to traffic signals.

Here are ways to increase your safety in city driving:

- Know the best way to get to where you are going. Get a city map and plan your trip into an unknown part of the city just as you would for a cross-country trip.
- Try to use the freeways that rim and crisscross most large cities. You will save time and energy. See *Freeway Driving* on page 339.
- Treat a green light as a warning signal. A traffic light is there because the corner is busy enough to need it. When a light turns green, and just before you start to move, check both ways for vehicles that have not cleared the intersection or may be running the red light.

## Freeway Driving



Mile for mile, freeways — also called thruways, parkways, expressways, turnpikes, or superhighways — are the safest of all roads. But they have their own special rules.

The most important advice on freeway driving is: Keep up with traffic and keep to the right. Drive at the same speed most of the other drivers are driving. Too-fast or too-slow driving breaks a smooth traffic flow. Treat the left lane on a freeway as a passing lane.

At the entrance, there is usually a ramp that leads to the freeway. If you have a clear view of the freeway as you drive along the entrance ramp, you should begin to check traffic. Try to determine where you expect to blend with the flow. Try to merge into the gap at close to the prevailing speed. Switch on your turn signal, check your mirrors, and glance over your shoulder as often as necessary. Try to blend smoothly with the traffic flow.

Once you are on the freeway, adjust your speed to the posted limit or to the prevailing rate if it is slower. Stay in the right lane unless you want to pass.

Before changing lanes, check your mirrors. Then use your turn signal.

Just before you leave the lane, glance quickly over your shoulder to make sure there is not another vehicle in your blind spot.

Once you are moving on the freeway, make certain you allow a reasonable following distance. Expect to move slightly slower at night.

When you want to leave the freeway, move to the proper lane well in advance. If you miss your exit, do not, under any circumstances, stop and back up. Drive on to the next exit.

The exit ramp can be curved, sometimes quite sharply. The exit speed is usually posted.

Reduce your speed according to your speedometer, not to your sense of motion. After driving for any distance at higher speeds, you may tend to think you are going slower than you actually are.

## Before Leaving on a Long Trip

Make sure you are ready. Try to be well rested. If you must start when you are not fresh — such as after a day's work — do not plan to make too many miles that first part of the journey. Wear comfortable clothing and shoes you can easily drive in.

Is your vehicle ready for a long trip? If you keep it serviced and maintained, it is ready to go. If it needs service, have it done before starting out. Of course, you will find experienced and able service experts in GM dealerships all across North America. They will be ready and willing to help if you need it.

Here are some things you can check before a trip:

- *Windshield Washer Fluid:* Is the reservoir full? Are all windows clean inside and outside?
- *Wiper Blades:* Are they in good shape?
- *Fuel, Engine Oil, Other Fluids:* Have you checked all levels?
- *Lamps:* Are they all working? Are the lenses clean?
- *Tires:* They are vitally important to a safe, trouble-free trip. Is the tread good enough for long-distance driving? Are the tires all inflated to the recommended pressure?
- *Weather Forecasts:* What is the weather outlook along your route? Should you delay your trip a short time to avoid a major storm system?
- *Maps:* Do you have up-to-date maps?

## Highway Hypnosis

Is there actually such a condition as highway hypnosis? Or is it just plain falling asleep at the wheel? Call it highway hypnosis, lack of awareness, or whatever.

There is something about an easy stretch of road with the same scenery, along with the hum of the tires on the road, the drone of the engine, and the rush of the wind against the vehicle that can make you sleepy. Do not let it happen to you! If it does, your vehicle can leave the road in less than a second, and you could crash and be injured.

What can you do about highway hypnosis? First, be aware that it can happen.

Then here are some tips:

- Make sure your vehicle is well ventilated, with a comfortably cool interior.
- Keep your eyes moving. Scan the road ahead and to the sides. Check your mirrors and your instruments frequently.
- If you get sleepy, pull off the road into a rest, service, or parking area and take a nap, get some exercise, or both. For safety, treat drowsiness on the highway as an emergency.

## Hill and Mountain Roads



Driving on steep hills or mountains is different from driving in flat or rolling terrain.

If you drive regularly in steep country, or if you are planning to visit there, here are some tips that can make your trips safer and more enjoyable. See *Off-Road Driving (Except SS) on page 317* for information about driving off-road.

- Keep your vehicle in good shape. Check all fluid levels and also the brakes, tires, cooling system, and transmission. These parts can work hard on mountain roads.

### **CAUTION:**

**If you do not shift down, your brakes could get so hot that they would not work well. You would then have poor braking or even none going down a hill. You could crash. Shift down to let your engine assist your brakes on a steep downhill slope.**

 **CAUTION:**

**Coasting downhill in NEUTRAL (N) or with the ignition off is dangerous. Your brakes will have to do all the work of slowing down. They could get so hot that they would not work well. You would then have poor braking or even none going down a hill. You could crash. Always have your engine running and your vehicle in gear when you go downhill.**

- Know how to go down hills. The most important thing to know is this: let your engine do some of the slowing down. Shift to a lower gear when you go down a steep or long hill.
- Know how to go uphill. You may want to shift down to a lower gear. The lower gears help cool your engine and transmission, and you can climb the hill better.

- Stay in your own lane when driving on two-lane roads in hills or mountains. Do not swing wide or cut across the center of the road. Drive at speeds that let you stay in your own lane.
- As you go over the top of a hill, be alert. There could be something in your lane, like a stalled car or an accident.
- You may see highway signs on mountains that warn of special problems. Examples are long grades, passing or no-passing zones, a falling rocks area, or winding roads. Be alert to these and take appropriate action.

## Winter Driving



Here are some tips for winter driving:

- Have your vehicle in good shape for winter.
- You may want to put winter emergency supplies in your vehicle.

Also see *Tires* on page 443.

Include an ice scraper, a small brush or broom, a supply of windshield washer fluid, a rag, some winter outer clothing, a small shovel, a flashlight, a red cloth, and reflective warning triangles. And, if you will be driving under severe conditions, include a small bag of sand, a piece of old carpet, or a couple of burlap bags to help provide traction. Be sure you properly secure these items in your vehicle.

### Driving on Snow or Ice

Most of the time, those places where the tires meet the road probably have good traction.

However, if there is snow or ice between the tires and the road, you can have a very slippery situation. You will have a lot less traction, or grip, and will need to be very careful.



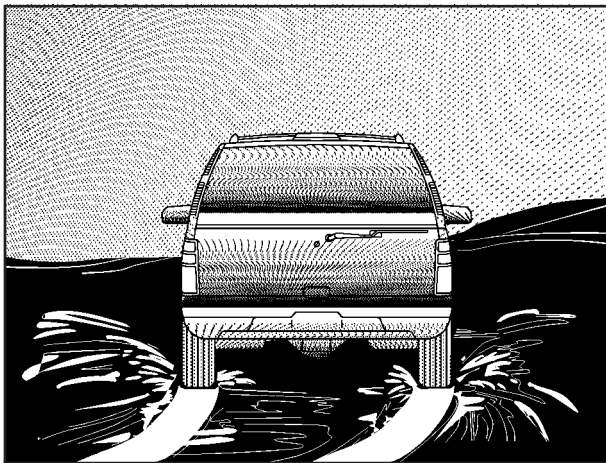

What is the worst time for this? Wet ice. Very cold snow or ice can be slick and hard to drive on. But wet ice can be even more trouble because it may offer the least traction of all. You can get wet ice when it is about freezing, 32°F (0°C), and freezing rain begins to fall. Try to avoid driving on wet ice until salt and sand crews can get there.

Whatever the condition — smooth ice, packed, blowing, or loose snow — drive with caution.

Accelerate gently. Try not to break the fragile traction. If you accelerate too fast, the drive wheels will spin and polish the surface under the tires even more.

The Anti-Lock Brake System (ABS) improves your vehicle's stability when you make a hard stop on a slippery road. Even though you have ABS, you will want to begin stopping sooner than you would on dry pavement. See *Anti-Lock Brake System (ABS)* on page 305.

- Allow greater following distance on any slippery road.
- Watch for slippery spots. The road might be fine until you hit a spot that is covered with ice. On an otherwise clear road, ice patches may appear in shaded areas where the sun cannot reach, such as around clumps of trees, behind buildings, or under bridges. Sometimes the surface of a curve or an overpass may remain icy when the surrounding roads are clear. If you see a patch of ice ahead of you, brake before you are on it. Try not to brake while you are actually on the ice, and avoid sudden steering maneuvers.

## If You Are Caught in a Blizzard

If you are stopped by heavy snow, you could be in a serious situation. You should probably stay with your vehicle unless you know for sure that you are near help and you can hike through the snow. Here are some things to do to summon help and keep yourself and your passengers safe:

- Turn on your hazard flashers.
- Tie a red cloth to your vehicle to alert police that you have been stopped by the snow.
- Put on extra clothing or wrap a blanket around you. If you do not have blankets or extra clothing, make body insulators from newspapers, burlap bags, rags, floor mats — anything you can wrap around yourself or tuck under your clothing to keep warm.

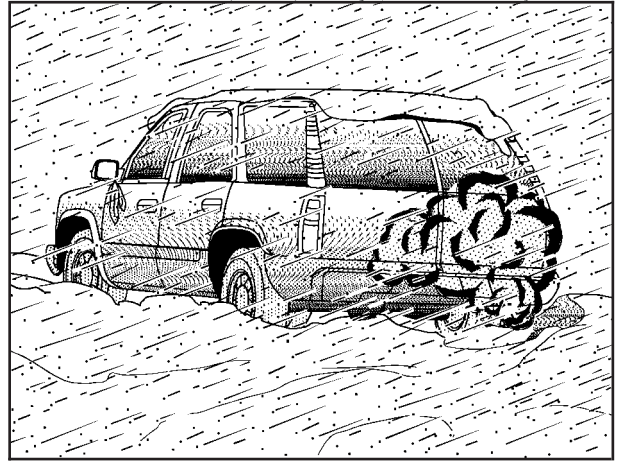

You can run the engine to keep warm, but be careful.

 **CAUTION:**

**Snow can trap exhaust gases under your vehicle. This can cause deadly CO (carbon monoxide) gas to get inside. CO could overcome you and kill you. You cannot see it or smell it, so you might not know it is in your vehicle. Clear away snow from around the base of your vehicle, especially any that is blocking your exhaust pipe. And check around again from time to time to be sure snow does not collect there.**

**Open a window just a little on the side of the vehicle that is away from the wind. This will help keep CO out.**

Run your engine only as long as you must. This saves fuel. When you run the engine, make it go a little faster than just idle. That is, push the accelerator slightly. This uses less fuel for the heat that you get and it keeps the battery charged. You will need a well-charged battery to restart the vehicle, and possibly for signaling later on with your headlamps. Let the heater run for a while.

Then, shut the engine off and close the window almost all the way to preserve the heat. Start the engine again and repeat this only when you feel really uncomfortable from the cold. But do it as little as possible. Preserve the fuel as long as you can. To help keep warm, you can get out of the vehicle and do some fairly vigorous exercises every half hour or so until help comes.

## If Your Vehicle is Stuck in Sand, Mud, Ice, or Snow

In order to free your vehicle when it is stuck, you will need to spin the wheels, but you do not want to spin your wheels too fast. The method known as rocking can help you get out when you are stuck, but you must use caution.

### CAUTION:

**If you let your vehicle's tires spin at high speed, they can explode, and you or others could be injured. And, the transmission or other parts of the vehicle can overheat. That could cause an engine compartment fire or other damage. When you are stuck, spin the wheels as little as possible. Do not spin the wheels above 35 mph (55 km/h) as shown on the speedometer.**

**Notice:** Spinning the wheels can destroy parts of your vehicle as well as the tires. If you spin the wheels too fast while shifting the transmission back and forth, you can destroy the transmission.

For information about using tire chains on your vehicle, see *Tire Chains* on page 468.

## Rocking Your Vehicle to Get It Out

First, turn the steering wheel left and right. That will clear the area around the front wheels. If you have a four-wheel-drive vehicle, shift into Four-Wheel High. Turn the StabiliTrak<sup>®</sup> System off. See *StabiliTrak<sup>®</sup> System* on page 307. Then shift back and forth between REVERSE (R) and a forward gear, spinning the wheels as little as possible. Release the accelerator pedal while you shift, and press lightly on the accelerator pedal when the transmission is in gear. By slowly spinning the wheels in the forward and reverse directions, you will cause a rocking motion that may free your vehicle. If that does not get your vehicle out after a few tries, it may need to be towed out. Or, you can use the recovery hooks if your vehicle has them. If your vehicle does need to be towed out, see *Towing Your Vehicle* on page 356.

## Recovery Hooks

### ⚠ CAUTION:

These hooks, when used, are under a lot of force. Always pull the vehicle straight out. Never pull on the hooks at a sideways angle. The hooks could break off and you or others could be injured from the chain or cable snapping back.

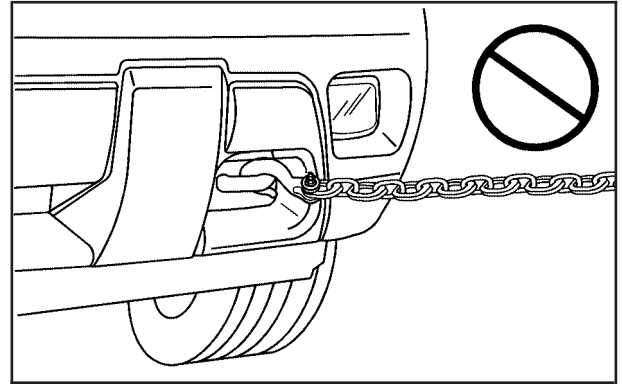

**Notice:** Never use recovery hooks to tow the vehicle. Your vehicle could be damaged and it would not be covered by warranty.

Your vehicle may have recovery hooks at the front of the vehicle. You may need to use them if you're stuck off-road and need to be pulled to some place where you can continue driving.

## Loading Your Vehicle

It is very important to know how much weight your vehicle can carry. This weight is called the vehicle capacity weight and includes the weight of all occupants, cargo, and all nonfactory-installed options. Two labels on your vehicle show how much weight it was designed to carry, the Tire and Loading Information label and the Certification/Tire label.

### CAUTION:

**Do not load your vehicle any heavier than the Gross Vehicle Weight Rating (GVWR), or either the maximum front or rear Gross Axle Weight Rating (GAWR). If you do, parts on your vehicle can break, and it can change the way your vehicle handles. These could cause you to lose control and crash. Also, overloading can shorten the life of your vehicle.**

## Tire and Loading Information Label

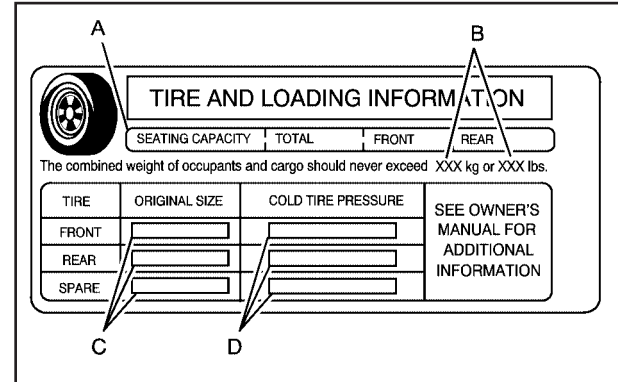

### Label Example

A vehicle specific Tire and Loading Information label is attached to the center pillar (B-pillar). With the driver's door open, you will find the label attached below the door lock post (striker). The tire and loading information label shows the number of occupant seating positions (A), and the maximum vehicle capacity weight (B) in kilograms and pounds.

The Tire and Loading Information label also shows the size of the original equipment tires (C) and the recommended cold tire inflation pressures (D). For more information on tires and inflation see *Tires on page 443* and *Inflation - Tire Pressure on page 452*.

There is also important loading information on the vehicle Certification/Tire label. It tells you the Gross Vehicle Weight Rating (GVWR) and the Gross Axle Weight Rating (GAWR) for the front and rear axle. See “Certification/Tire Label” later in this section.

### **Steps for Determining Correct Load Limit**

1. Locate the statement “The combined weight of occupants and cargo should never exceed XXX kg or XXX lbs” on your vehicle’s placard.
2. Determine the combined weight of the driver and passengers that will be riding in your vehicle.
3. Subtract the combined weight of the driver and passengers from XXX kg or XXX lbs.
4. The resulting figure equals the available amount of cargo and luggage load capacity. For example, if the “XXX” amount equals 1400 lbs and there will be five 150 lb passengers in your vehicle, the amount of available cargo and luggage load capacity is 650 lbs (1400 – 750 (5 x 150) = 650 lbs).
5. Determine the combined weight of luggage and cargo being loaded on the vehicle. That weight may not safely exceed the available cargo and luggage load capacity calculated in Step 4.
6. If your vehicle will be towing a trailer, the load from your trailer will be transferred to your vehicle. Consult this manual to determine how this reduces the available cargo and luggage load capacity of your vehicle. See *Towing a Trailer on page 363* for important information on towing a trailer, towing safety rules and trailering tips.

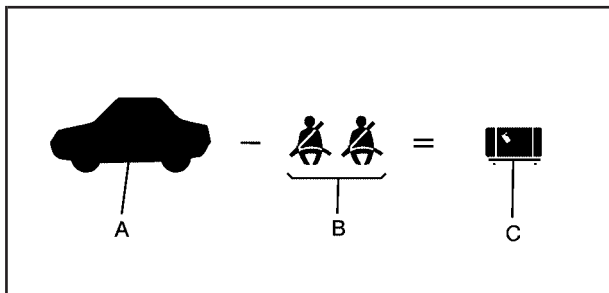

**Example 1**

Item	Description	Total
A	Vehicle Capacity Weight for Example 1 =	1,000 lbs (453 kg)
B	Subtract Occupant Weight 150 lbs (68 kg) × 2 =	300 lbs (136 kg)
C	Available Occupant and Cargo Weight =	700 lbs (317 kg)

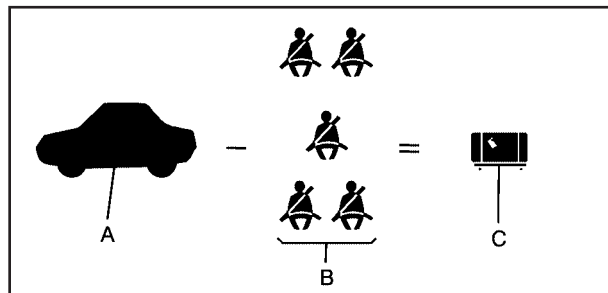

**Example 2**

Item	Description	Total
A	Vehicle Capacity Weight for Example 2 =	1,000 lbs (453 kg)
B	Subtract Occupant Weight 150 lbs (68 kg) × 5 =	750 lbs (136 kg)
C	Available Cargo Weight =	250 lbs (113 kg)



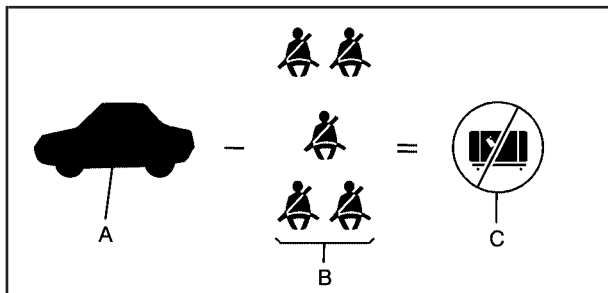

**Example 3**

Item	Description	Total
A	Vehicle Capacity Weight for Example 3 =	1,000 lbs (453 kg)
B	Subtract Occupant Weight 200 lbs (91 kg) × 5 =	1,000 lbs (453 kg)
C	Available Cargo Weight =	0 lbs (0 kg)

Refer to your vehicle's tire and loading information label for specific information about your vehicle's capacity weight and seating positions. The combined weight of the driver, passengers, and cargo should never exceed your vehicle's capacity weight.

Your vehicle may have an electronically controlled air suspension system that automatically keeps your vehicle level as you load and unload your vehicle. See *Electronically Controlled Air Suspension System* on page 361 for additional information.

### Certification/Tire Label

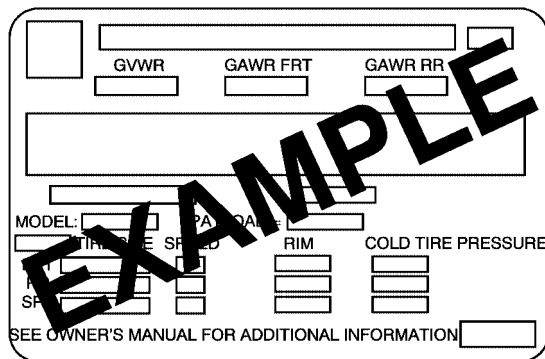

A vehicle specific Certification/Tire label is found on the rear edge of the driver's door. The label shows the size of your vehicle's original tires and the inflation pressures needed to obtain the gross weight capacity of your vehicle. This is called Gross Vehicle Weight Rating (GVWR).

The GVWR includes the weight of the vehicle, all occupants, fuel, cargo, and trailer tongue weight, if pulling a trailer.

The Certification/Tire label also tells you the maximum weights for the front and rear axles, called Gross Axle Weight Rating (GAWR). To find out the actual loads on your front and rear axles, you need to go to a weigh station and weigh your vehicle. Your dealer can help you with this. Be sure to spread out your load equally on both sides of the centerline.

Never exceed the GVWR for your vehicle, or the GAWR for either the front or rear axle.

And, if you do have a heavy load, you should spread it out.

Similar appearing vehicles may have different GVWRs and capacity weights. Please note your vehicle's Certification/Tire label or consult your dealer for additional details.

 **CAUTION:**

**Do not load your vehicle any heavier than the Gross Vehicle Weight Rating (GVWR), or either the maximum front or rear Gross Axle Weight Rating (GAWR). If you do, parts on your vehicle can break, and it can change the way your vehicle handles. These could cause you to lose control and crash. Also, overloading can shorten the life of your vehicle.**

Using heavier suspension components to get added durability might not change your vehicle's weight ratings. Ask your dealer to help you load your vehicle the right way.

**Notice:** Overloading your vehicle may cause damage. Repairs would not be covered by your warranty. Do not overload your vehicle.

If you put things inside your vehicle — like suitcases, tools, packages, or anything else — they will go as fast as the vehicle goes. If you have to stop or turn quickly, or if there is a crash, they will keep going.

 **CAUTION:**

**Things you put inside your vehicle can strike and injure people in a sudden stop or turn, or in a crash.**

- **Put things in the cargo area of your vehicle. Try to spread the weight evenly.**
- **Never stack heavier things, like suitcases, inside the vehicle so that some of them are above the tops of the seats.**
- **Do not leave an unsecured child restraint in your vehicle.**
- **When you carry something inside the vehicle, secure it whenever you can.**
- **Do not leave a seat folded down unless you need to.**

There is also important loading information for off-road driving in this manual. See “Loading Your Vehicle for Off-Road Driving” under *Off-Road Driving (Except SS)* on page 317.

## **Adding a Snow Plow or Similar Equipment**

Your vehicle was neither designed nor intended for a snow plow.

**Notice:** Adding a snow plow or similar equipment to your vehicle can damage it, and the repairs would not be covered by warranty. Do not install a snow plow or similar equipment on your vehicle.

# Towing

## Towing Your Vehicle

Consult your dealer or a professional towing service if you need to have your disabled vehicle towed. See *Roadside Assistance Program on page 542*.

If you want to tow your vehicle behind another vehicle for recreational purposes (such as behind a motorhome), see “Recreational Vehicle Towing” following.

## Recreational Vehicle Towing

Recreational vehicle towing means towing your vehicle behind another vehicle – such as behind a motorhome. The two most common types of recreational vehicle towing are known as “dinghy towing” (towing your vehicle with all four wheels on the ground) and “dolly towing” (towing your vehicle with two wheels on the ground and two wheels up on a device known as a “dolly”).

With the proper preparation and equipment, many vehicles can be towed in these ways. See “Dinghy Towing” and “Dolly Towing,” following. You may also need brakes for the vehicle being towed. See your dealer for additional trailering information.

Here are some important things to consider before you do recreational vehicle towing:

- What’s the trailering capacity of the towing vehicle? Be sure you read the tow vehicle manufacturer’s recommendations.
- How far will you tow? Some vehicles have restrictions on how far and how long they can be towed.
- Do you have the proper towing equipment? See your dealer or trailering professional for additional advice and equipment recommendations.
- Is your vehicle ready to be towed? Just as you would prepare your vehicle for a long trip, you’ll want to make sure your vehicle is prepared to be towed. See *Before Leaving on a Long Trip on page 340*.

## All-Wheel-Drive Vehicles (TrailBlazer SS)

**Notice:** Towing an all-wheel-drive vehicle with all four wheels on the ground, or even with only two of its wheels on the ground, will damage drivetrain components. Do not tow an all-wheel-drive vehicle if any of its wheels will be on the ground.

Your vehicle was not designed to be towed with any of its wheels on the ground. If your vehicle must be towed, see “Towing Your Vehicle” earlier in this section.

## Dinghy Towing

### Two-Wheel-Drive Vehicles

**Notice:** If you tow your vehicle with all four wheels on the ground, the drivetrain components could be damaged. The repairs would not be covered by your warranty. Do not tow your vehicle with all four wheels on the ground.

Two-wheel-drive vehicles should not be towed with all four wheels on the ground. Two-wheel-drive transmissions have no provisions for internal lubrication while being towed. To properly tow these vehicles, they should be placed on a platform trailer.

### Four-Wheel-Drive Vehicles

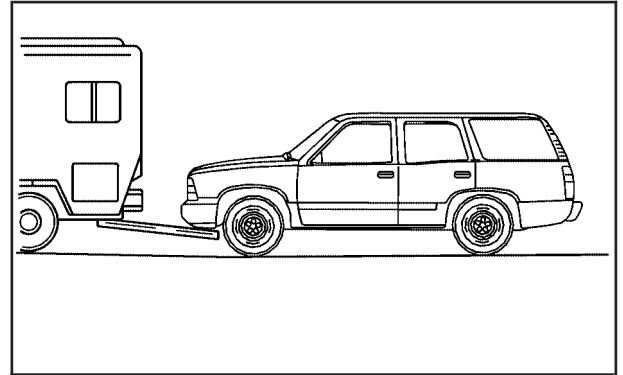

Four-wheel-drive vehicles can be dinghy towed if you follow the proper procedures. The transmission has no provisions for internal lubrication while being towed, so it is important that you follow all the steps listed in this manual to dinghy tow your four-wheel-drive vehicle.

Use the following procedure to tow your vehicle:

1. Shift the transmission to PARK (P).
2. Turn the engine off, but leave the ignition on.
3. Firmly set the parking brake.
4. Securely attach the vehicle being towed to the tow vehicle.

 **CAUTION:**

**Shifting a four-wheel-drive vehicle's transfer case into NEUTRAL can cause your vehicle to roll even if the transmission is in PARK (P). You or others could be injured. Make sure the parking brake is firmly set before you shift the transfer case to NEUTRAL.**

5. Shift the transfer case to NEUTRAL (N). See *Four-Wheel Drive on page 122* for the proper procedure to select the NEUTRAL (N) position for your vehicle.

6. Release the parking brake only after the vehicle being towed is firmly attached to the towing vehicle.
7. Turn the ignition off.

After towing, see "Shifting Out of Neutral" under *Four-Wheel Drive on page 122*.

## Dolly Towing

### Front Towing (Front Wheels Off the Ground)

#### Two-Wheel-Drive Vehicles

**Notice:** If you tow a two-wheel-drive vehicle with the rear wheels on the ground, the transmission could be damaged. The repairs would not be covered by your warranty. Never tow your vehicle with the rear wheels on the ground.

## Four-Wheel-Drive Vehicles

Four-wheel-drive vehicles can be dolly towed with the rear wheels on the ground.

Use the following procedure to tow your vehicle:

1. Drive the vehicle onto the tow dolly.
2. Shift the automatic transmission to PARK (P).
3. Turn the engine off, but leave the ignition on.
4. Firmly set the parking brake.
5. Securely attach the vehicle being towed to the dolly.

6. Shift the transfer case to NEUTRAL (N). See *Four-Wheel Drive on page 122* for the proper procedure to select the NEUTRAL (N) position for your vehicle.
7. Release the parking brake only after the vehicle being towed is firmly attached to the towing vehicle.
8. Turn the ignition off.

After towing, see “Shifting Out of Neutral” under *Four-Wheel Drive on page 122*.

### CAUTION:

**Shifting a four-wheel-drive vehicle’s transfer case into NEUTRAL can cause your vehicle to roll even if the transmission is in PARK (P). You or others could be injured. Make sure the parking brake is firmly set before you shift the transfer case to NEUTRAL.**

## Rear Towing (Rear Wheels Off the Ground) (Two-Wheel or Four-Wheel-Drive Vehicles)

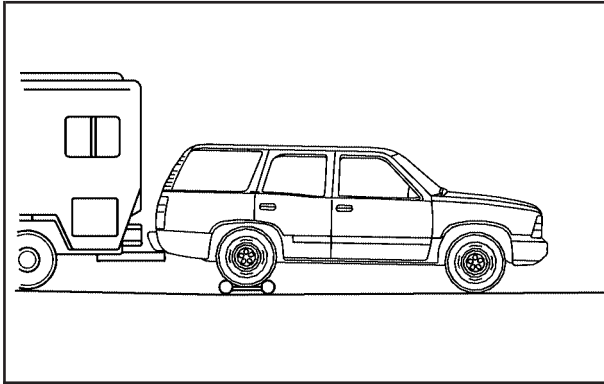

Use the following procedure to tow your vehicle from the rear:

1. Drive the vehicle onto the dolly.
2. Firmly set the parking brake. See *Parking Brake on page 126* for more information.
3. Shift the transmission in PARK (P).

4. Follow the dolly manufacturer's instructions to attach and secure the vehicle being towed to the dolly and then the loaded dolly to the tow vehicle. Use an adequate clamping device to ensure that the front wheels are locked into the straight position.
5. Release the parking brake only after the vehicle being towed is firmly attached to the towing vehicle.
6. Turn the ignition to LOCK.

If the tow vehicle will not be started or driven for six weeks or more, remove the battery cable from the negative terminal (post) of the battery.



## Electronically Controlled Air Suspension System

Your vehicle may be equipped with an electronically controlled air suspension system that automatically keeps your vehicle level as you load and unload. The system includes a compressor, two height sensors and two air springs supporting the rear axle.

The system also has an internal clock to prevent overheating if the inflator is used for prolonged periods. If the system overheats, all leveling function stops until the system cools down. During this time, the indicator light on the air inflator switch will be flashing.

The ignition has to be on for the system to inflate, in order to raise the vehicle to the standard ride height after loading. The system can lower the vehicle to the standard ride height after unloading with the ignition on and also for up to 30 minutes after the ignition has been turned off.

You may hear the compressor operating when you load your vehicle, and periodically as the system adjusts the vehicle to the standard ride height.

Load leveling will not function normally with the inflator hose attached to the inflator outlet. Remove the inflator hose from the outlet during loading and unloading.

If the vehicle is parked for an extended period of time, some bleed down of the suspension is normal. Upon starting the vehicle, proper height will be achieved.

## Overload Protection

The air suspension system is equipped with overload protection. Overload protection is designed to protect the air suspension system, and it is an indicator to the driver that the vehicle is overloaded. When the overload protection mode is on, it will not allow damage to the air compressor. However, do not overload the vehicle. See *Loading Your Vehicle on page 350*.

If the suspension remains at a low height, the rear axle load has exceeded GAWR (Gross Axle Weight Rating). When the overload protection mode is activated, the compressor operates for about 30 seconds to one minute without raising the vehicle depending on the amount of overload. This will continue each time the ignition is turned on until the rear axle load is reduced below GAWR.

## Indicator Light

The indicator light on the inflator switch in the rear passenger compartment also serves as an indicator for internal system error. If the indicator light is flashing without the load leveling function or the inflator being active, turn off the ignition. The next day turn on the ignition and check the indicator light. The vehicle can be driven with the light flashing, but if it is you should have the vehicle serviced as soon as possible.

## Towing a Trailer

### CAUTION:

**If you do not use the correct equipment and drive properly, you can lose control when you pull a trailer. For example, if the trailer is too heavy, the brakes may not work well — or even at all. You and your passengers could be seriously injured. You may also damage your vehicle; the resulting repairs would not be covered by your warranty. Pull a trailer only if you have followed all the steps in this section. Ask your dealer for advice and information about towing a trailer with your vehicle.**

**Notice:** Pulling a trailer improperly can damage your vehicle and result in costly repairs that would not be covered by your warranty. Always follow the instructions in this section and check with your dealer for more information about towing a trailer with your vehicle.

To identify the trailering capacity of your vehicle, you should read the information in “Weight of the Trailer” that appears later in this section.

Trailering is different than just driving your vehicle by itself. Trailering means changes in acceleration, braking, handling, durability and fuel economy. Successful, safe trailering takes correct equipment, and it has to be used properly.

That’s the reason for this part. In it are many time-tested, important trailering tips and safety rules. Many of these are important for your safety and that of your passengers. So please read this section carefully before you pull a trailer.

## If You Do Decide To Pull A Trailer

If you do, here are some important points:

- There are many different laws, including speed limit restrictions, having to do with trailering. Make sure your rig will be legal, not only where you live but also where you'll be driving. A good source for this information can be state or provincial police.
- Consider using a sway control. See "Hitches" later in this section.
- Don't tow a trailer at all during the first 500 miles (800 km) your new vehicle is driven. Your engine, axle or other parts could be damaged.
- Then, during the first 500 miles (800 km) that you tow a trailer, don't drive over 50 mph (80 km/h) and don't make starts at full throttle. This helps your engine and other parts of your vehicle wear in at the heavier loads.
- You can tow in DRIVE (D). You may want to shift the transmission to THIRD (3) or, if necessary, a lower gear selection if the transmission shifts too often (e.g., under heavy loads and/or hilly conditions).

Three important considerations have to do with weight:

- the weight of the trailer,
- the weight of the trailer tongue
- and the weight on your vehicle's tires.

## Weight of the Trailer

How heavy can a trailer safely be?

It depends on how you plan to use your rig. For example, speed, altitude, road grades, outside temperature and how much your vehicle is used to pull a trailer are all important. It can also depend on any special equipment that you have on your vehicle, and the amount of tongue weight the vehicle can carry. See "Weight of the Trailer Tongue" later in this section for more information.

Maximum trailer weight is calculated assuming only the driver is in the tow vehicle and it has all the required trailering equipment. The weight of additional optional equipment, passengers and cargo in the tow vehicle must be subtracted from the maximum trailer weight.

Look in the following chart to find the maximum trailer weight for your vehicle.

Vehicle	Axle Ratio	Max.Trailer Wt.	*GCWR
2WD TrailBlazer (L6 Engine)	3.42	5,400 lbs (2 449 kg)	10,000 lbs (4 536 kg)
	3.73	5,900 lbs (2 676 kg)	10,500 lbs (4 763 kg)
	4.10	6,400 lbs (2 903 kg)	11,000 lbs (4 990 kg)
4WD TrailBlazer (L6 Engine)	3.42	5,200 lbs (2 359 kg)	10,000 lbs (4 536 kg)
	3.73	5,700 lbs (2 585 kg)	10,500 lbs (4 763 kg)
	4.10	6,200 lbs (2 812 kg)	11,000 lbs (4 990 kg)
2WD TrailBlazer (V8 Engine)	3.42	6,300 lbs (2 858 kg)	11,000 lbs (4 990 kg)
	3.73	6,800 lbs (3 084 kg)	11,500 lbs (5 216 kg)
4WD TrailBlazer (V8 Engine)	3.42	6,100 lbs (2 767 kg)	11,000 lbs (4 990 kg)
	3.73	6,600 lbs (2 994 kg)	11,500 lbs (5 216 kg)
**2WD TrailBlazer SS (6.0 L V8 Engine)	4.10	6,800 lbs (3 084 kg)	11,500 lbs (5 216 kg)
**AWD TrailBlazer SS (6.0 L V8 Engine)	4.10	6,600 lbs (2 994 kg)	11,500 lbs (5 216 kg)

\*The Gross Combination Weight Rating (GCWR) is the total allowable weight of the completely loaded vehicle and trailer including any passengers, cargo, equipment and conversion. The GCWR for your vehicle should not be exceeded.

\*\*TrailBlazer SS models with the 6.0L engine require Performance Sport Package (B4U).

You can ask your dealer for our trailering information or advice, or you can write us at the address listed in your Warranty and Owner Assistance Information Booklet.

In Canada, write to:

General Motors of Canada Limited  
Customer Communication Centre, 163-005  
1908 Colonel Sam Drive  
Oshawa, Ontario L1H 8P7

## Weight of the Trailer Tongue

The tongue load (A) of any trailer is an important weight to measure because it affects the total or gross weight of your vehicle. The Gross Vehicle Weight (GVW) includes the curb weight of the vehicle, any cargo you may carry in it, and the people who will be riding in the vehicle. If you have a lot of options, equipment, passengers or cargo in your vehicle, it will reduce the tongue weight your vehicle can carry, which will also reduce the trailer weight your vehicle can tow. And if you will tow a trailer, you must add the tongue load to the GVW

because your vehicle will be carrying that weight, too. See *Loading Your Vehicle* on page 350 for more information about your vehicle's maximum load capacity.

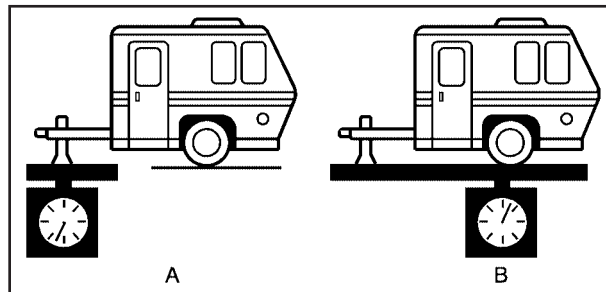

The trailer tongue weight (A) should be 10 percent to 15 percent of the total loaded trailer weight, up to a maximum of 400 lbs (181 kg) with a weight carrying hitch. The trailer tongue weight (A) should be 10 percent to 15 percent of the total loaded trailer weight, up to a maximum of 900 lbs (408 kg) with a weight distributing hitch.

Do not exceed the maximum allowable tongue weight for your vehicle. Choose the shortest hitch extension that will position the hitch ball closest to the vehicle. This will help reduce the effect of trailer tongue weight on the rear axle.

After you've loaded your trailer, weigh the trailer and then the tongue, separately, to see if the weights are proper. If they aren't, you may be able to get them right simply by moving some items around in the trailer.

Trailer may be limited by the vehicle's ability to carry tongue weight. Tongue weight cannot cause the vehicle to exceed the GVWR (Gross Vehicle Weight Rating) or the RGAWR (Rear Gross Axle Weight Rating). The effect of additional weight may reduce your trailering capacity more than the total of the additional weight.

Consider the following example:

A vehicle model base weight is 5,500 lbs (2 495 kg); 2,800 lbs (1 270 kg) at the front axle and 2,700 lbs (1 225 kg) at the rear axle.

It has a GVWR of 7,200 lbs (3 266 kg), a RGAWR of 4,000 lbs (1 814 kg) and a GCWR (Gross Combination Weight Rating) of 14,000 lbs (6 350 kg). The trailer rating should be:

14,000 lbs (6350 kg)	GCWR
<u>-5,500 lbs (2495 kg)</u>	Vehicle Weight
8,500 lbs (3855 kg)	Trailer Rating

You can expect tongue weight to be at least 10 percent of trailer weight (850 lbs (386 kg)) and because the weight is applied well behind the rear axle, the effect on the rear axle will be greater than just the weight itself, as much as 1.5 times as much. The weight at the rear axle could be 850 lbs (386 kg) X 1.5 = 1,275 lbs (578 kg). Since the rear axle already weighs 2,700 lbs (1 225 kg), adding 1,275 lbs (578 kg) brings the total to 3,975 lbs (1 803 kg). This is very close to, but within the limit for RGAWR as well. The vehicle is set to trailer up to 8,500 lbs (3 856 kg).

But let's say your specific vehicle is equipped with some of the latest options and you have a front seat passenger and two rear seat passengers with some luggage and gear in the vehicle as well. You may add 300 lbs (136 kg) to the front axle weight and 400 lbs (181 kg) to the rear axle weight. Your vehicle now weighs:

2,800 lbs (1270 kg)	+	300 lbs (136 kg)	Front
2,700 lbs (1225 kg)	+	400 lbs (181 kg)	Rear
<hr/>			
6,200 lbs (2812 kg)			Total

Weight is still below 7,200 lbs (3 266 kg) and you may think that you should subtract 700 additional pounds (318 kg) from your trailering capacity to stay within GCWR limits. Your maximum trailer would only be 7,800 lbs (3 538 kg). You may go further and think you must limit tongue weight to less than 1,000 lbs (454 kg) to avoid exceeding GVWR. But, you must still consider the effect on the rear axle. Because your rear axle now weighs 3,100 lbs (1 406 kg), you can only put 900 lbs (408 kg) on the rear axle without exceeding

RGAWR. The effect of tongue weight is about 1.5 times the actual weight. Dividing the 900 lbs (408 kg) by 1.5 leaves you with being able to handle only 600 lbs (272 kg) of tongue weight. Since tongue weight is usually at least 10 percent of total loaded trailer weight, you can expect that the largest trailer your vehicle can properly handle is 6,000 lbs (2 721 kg).

It is important that you make sure your vehicle does not exceed any of its ratings — GCWR, GVWR, RGAWR, Maximum Trailer Rating or Tongue Weight. The only way to be sure you are not exceeding any of these ratings is to weigh your vehicle and trailer.

## Total Weight on Your Vehicle's Tires

Be sure your vehicle's tires are inflated to the upper limit for cold tires. You'll find these numbers on the Certification label at the rear edge of the driver's door. See *Loading Your Vehicle on page 350* for more information. Then be sure you don't go over the GVW limit for your vehicle, or the GAWR, including the weight of the trailer tongue. If you use a weight distributing hitch, make sure you don't go over the rear axle limit before you apply the weight distribution spring bars.



## Hitches

It's important to have the correct hitch equipment. Crosswinds, large trucks going by and rough roads are a few reasons why you'll need the right hitch.

### Weight Distributing Hitches and Weight Carrying Hitches

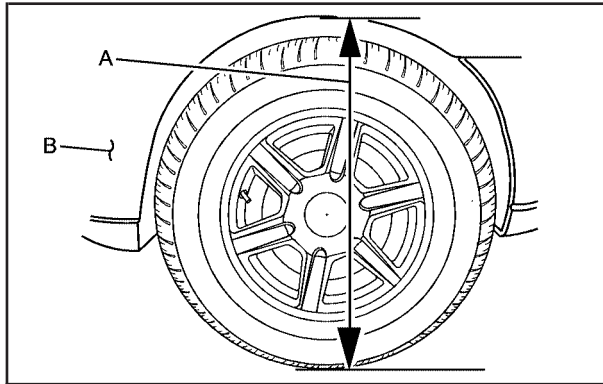

(A) Body to Ground Distance, (B) Front of Vehicle

When using a weight-distributing hitch, the hitch must be adjusted so the distance remains the same both before and after coupling the trailer to the tow vehicle.

If you use a step-bumper hitch, the bumper could be damaged in sharp turns. Make sure there is ample room when turning to avoid contact between the trailer and the bumper.

If you will be pulling a trailer that, when loaded, will weigh more than 4,000 lbs (1 814 kg) be sure to use a properly mounted weight-distributing hitch and sway control of the proper size. This equipment is very important for proper vehicle loading and good handling when driving. Always use a sway control if the trailer will weigh more than these limits. You can ask a hitch dealer about sway controls.

### Safety Chains

You should always attach chains between your vehicle and your trailer. Cross the safety chains under the tongue of the trailer to help prevent the tongue from contacting the road if it becomes separated from the hitch. Instructions about safety chains may be provided by the hitch manufacturer or by the trailer manufacturer. Follow the manufacturer's recommendation for attaching safety chains and do not attach them to the bumper. Always leave just enough slack so you can turn with your rig. Never allow safety chains to drag on the ground.

## Trailer Brakes

If your trailer weighs more than 1,500 lbs (680 kg) loaded, then it needs its own brakes — and they must be adequate. Be sure to read and follow the instructions for the trailer brakes so you'll be able to install, adjust and maintain them properly.

Your trailer's brake system can tap into the vehicle's hydraulic brake system only if:

- The trailer parts can withstand 3,000 psi (20 650 kPa) of pressure.
- The trailer's brake system will use less than 0.02 cubic inch (0.3 cc) of fluid from your vehicle's master cylinder. Otherwise, both braking systems won't work well. You could even lose your brakes.

If everything checks out this far, then make the brake fluid tap at the port on the master cylinder that sends fluid to the rear brakes. But don't use copper tubing for this. If you do, it will bend and finally break off. Use steel brake tubing.

## Driving with a Trailer

### CAUTION:

**If you have a rear-most window open and you pull a trailer with your vehicle, carbon monoxide (CO) could come into your vehicle. You can not see or smell CO. It can cause unconsciousness or death. See *Engine Exhaust on page 130*. To maximize your safety when towing a trailer:**

- **Have your exhaust system inspected for leaks and make necessary repairs before starting on your trip.**
- **Keep the rear-most windows closed.**

**CAUTION: (Continued)**

## CAUTION: (Continued)

- **If exhaust does come into your vehicle through a window in the rear or another opening, drive with your front, main heating or cooling system on and with the fan on any speed. This will bring fresh, outside air into your vehicle. Do not use the climate control setting for maximum air because it only recirculates the air inside your vehicle. See *Dual Climate Control System on page 185* or *Dual Automatic Climate Control System on page 188*.**

Towing a trailer requires a certain amount of experience. Before setting out for the open road, you'll want to get to know your rig. Acquaint yourself with the feel of handling and braking with the added weight of the trailer. And always keep in mind that the vehicle you are driving is now a good deal longer and not nearly as responsive as your vehicle is by itself.

Before you start, check all trailer hitch parts and attachments, safety chains, electrical connection, lamps, tires and mirror adjustment. If the trailer has electric brakes, start your vehicle and trailer moving and then apply the trailer brake controller by hand to be sure the brakes are working. This lets you check your electrical connection at the same time.

During your trip, check occasionally to be sure that the load is secure, and that the lamps and any trailer brakes are still working.

## Following Distance

Stay at least twice as far behind the vehicle ahead as you would when driving your vehicle without a trailer. This can help you avoid situations that require heavy braking and sudden turns.

## Passing

You'll need more passing distance up ahead when you're towing a trailer. And, because you're a good deal longer, you'll need to go much farther beyond the passed vehicle before you can return to your lane.

## Backing Up

Hold the bottom of the steering wheel with one hand. Then, to move the trailer to the left, just move that hand to the left. To move the trailer to the right, move your hand to the right. Always back up slowly and, if possible, have someone guide you.

## Making Turns

**Notice:** Making very sharp turns while trailering could cause the trailer to come in contact with the vehicle. Your vehicle could be damaged. Avoid making very sharp turns while trailering.

When you're turning with a trailer, make wider turns than normal. Do this so your trailer won't strike soft shoulders, curbs, road signs, trees or other objects. Avoid jerky or sudden maneuvers. Signal well in advance.

## Turn Signals When Towing a Trailer

The arrows on your instrument panel will flash whenever you signal a turn or lane change. Properly hooked up, the trailer lamps will also flash, telling other drivers you're about to turn, change lanes or stop.

When towing a trailer, the arrows on your instrument panel will flash for turns even if the bulbs on the trailer are burned out. Thus, you may think drivers behind you are seeing your signal when they are not. It's important to check occasionally to be sure the trailer bulbs are still working.

## Driving On Grades

Reduce speed and shift to a lower gear *before* you start down a long or steep downgrade. If you don't shift down, you might have to use your brakes so much that they would get hot and no longer work well.

You can tow in DRIVE (D). You may want to shift the transmission to THIRD (3) or a lower gear, under heavy loads or hilly conditions.

When towing at high altitude on steep uphill grades, consider the following: Engine coolant will boil at a lower temperature than at normal altitudes. If you turn your engine off immediately after towing at high altitude on steep uphill grades, your vehicle may show signs similar to engine overheating. To avoid this, let the engine run while parked (preferably on level ground) with the automatic transmission in PARK (P) for a few minutes before turning the engine off. If you do get the overheat warning, see *Engine Overheating on page 414*.

## Parking on Hills

### CAUTION:

**You really should not park your vehicle, with a trailer attached, on a hill. If something goes wrong, your rig could start to move. People can be injured, and both your vehicle and the trailer can be damaged.**

But if you ever have to park your rig on a hill, here's how to do it:

1. Apply your regular brakes, but don't shift into PARK (P) yet. When parking uphill, turn your wheels away from the curb. When parking downhill, turn your wheels into the curb.
2. Have someone place chocks behind the trailer wheels.
3. When the wheel chocks are in place, release the regular brakes until the chocks absorb the load.
4. Reapply the regular brakes. Then apply your parking brake, and then shift into PARK (P).
5. Release the regular brakes.

### CAUTION:

**It can be dangerous to get out of your vehicle if the shift lever is not fully in PARK (P) with the parking brake firmly set. Your vehicle can roll.**

**If you have left the engine running, the vehicle can move suddenly. You or others could be injured. To be sure your vehicle will not move, even when you are on fairly level ground, use the steps that follow.**

**Always put the shift lever fully in PARK (P) with the parking brake firmly set.**

**If the transfer case on four-wheel drive vehicles is in NEUTRAL, your vehicle will be free to roll, even if your shift lever is in PARK (P). So, be sure the transfer case is in a drive gear — not in NEUTRAL.**

**See *Four-Wheel Drive* on page 122.**

## When You Are Ready to Leave After Parking on a Hill

1. Apply your regular brakes and hold the pedal down while you:
  - start your engine,
  - shift into a gear, and
  - release the parking brake.
2. Let up on the brake pedal.
3. Drive slowly until the trailer is clear of the chocks.
4. Stop and have someone pick up and store the chocks.

## Maintenance When Trailer Towing

Your vehicle will need service more often when you're pulling a trailer. See the Maintenance Schedule for more on this. Things that are especially important in trailer operation are automatic transmission fluid (don't overfill), engine oil, axle lubricant, belt(s), cooling system and brake system. Each of these is covered in this manual, and the Index will help you find them quickly. If you're trailering, it's a good idea to review these sections before you start your trip.

Check periodically to see that all hitch nuts and bolts are tight.

## Trailer Wiring Harness

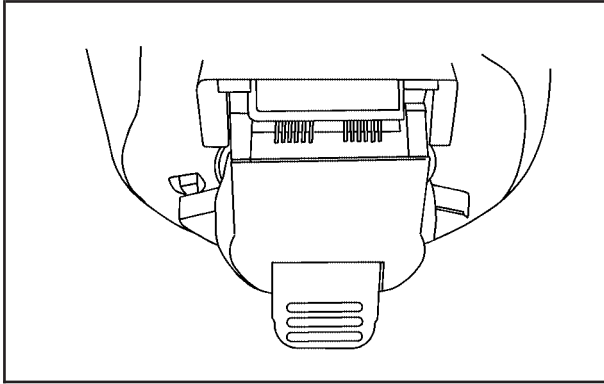

Your vehicle may have a seven-wire trailer towing harness. This harness may have a seven-pin universal heavy-duty trailer connector (if equipped with the trailering package) that is attached to a bracket on the hitch platform or included with the four-pin trailer towing harness. If your vehicle is not equipped with the heavy-duty trailer connector, you may purchase one from your dealer.

The seven-wire harness contains the following trailer circuits:

- Yellow: Left Stop/Turn Signal
- Dark Green: Right Stop/Turn Signal
- Brown: Running Lamps
- White: Ground
- Light Green: Back-up Lamps
- Dark Blue: Electric Brakes
- Red: Battery Feed (The chassis wiring ring terminal must be fastened to a stud on the underhood electrical center before the trailer feed will become active.)



If you need to tow a light-duty trailer with a standard four-way round pin connector, an adapter connector is available from your dealer.

If you are charging a remote (non-vehicle) battery, turn on the headlamps to boost the vehicle system voltage and properly charge the battery.

Your vehicle is also equipped with wiring for an electric trailer brake controller. These wires are located inside the vehicle on the driver's side under the instrument panel. These wires should be connected to an electric trailer brake controller by your dealer or a qualified service center.

Your vehicle may be equipped with a four-pin trailer towing harness. This harness has a four-pin trailer connector that contains the following trailer circuits:

- Yellow: Left Stop/Turn Signal
- Dark Green: Right Stop/Turn Signal
- Brown: Running Lamps
- White: Ground

This harness also contains the following trailer circuits that are not connected to the four-pin trailer connector:

- Light Green: Back-Up Lamps
- Dark Blue: Electric Brakes
- Red: Battery Feed

If your vehicle is a TrailBlazer SS, you were provided with a trailer wiring harness extension, and instructions for installing this extension, when your vehicle was delivered. This extension will allow your vehicle's trailer wiring harness to be more easily accessible. There is a four-way connector on the harness. A seven-way adapter plug is also included if your trailer requires it.



## Section 5 Service and Appearance Care

---

<b>Service</b> .....	382	Engine Coolant .....	411
Accessories and Modifications .....	382	Radiator Pressure Cap .....	414
California Proposition 65 Warning .....	383	Engine Overheating .....	414
Doing Your Own Service Work .....	383	Cooling System .....	416
Adding Equipment to the Outside of Your Vehicle .....	384	Engine Fan Noise .....	422
<b>Fuel</b> .....	384	Power Steering Fluid .....	422
Gasoline Octane .....	384	Windshield Washer Fluid .....	423
Gasoline Specifications .....	385	Brakes .....	424
California Fuel .....	385	Battery .....	428
Additives .....	385	Jump Starting .....	429
Fuels in Foreign Countries .....	386	<b>All-Wheel Drive</b> .....	434
Filling the Tank .....	387	<b>Rear Axle</b> .....	434
Filling a Portable Fuel Container .....	389	<b>Four-Wheel Drive</b> .....	435
<b>Checking Things Under the Hood</b> .....	390	<b>Front Axle</b> .....	436
Hood Release .....	390	<b>Bulb Replacement</b> .....	437
Engine Compartment Overview .....	392	Halogen Bulbs .....	437
Engine Oil .....	398	Taillamps and Turn Signal Lamps .....	438
Engine Oil Life System .....	404	License Plate Lamp .....	439
Engine Air Cleaner/Filter .....	406	Replacement Bulbs .....	439
Automatic Transmission Fluid .....	407	<b>Windshield Wiper Blade Replacement</b> .....	440

## Section 5 Service and Appearance Care

---

<b>Tires</b> .....	443	Storing a Flat or Spare Tire and Tools .....	486
Winter Tires .....	444	Spare Tire .....	489
Tire Sidewall Labeling .....	445	<b>Appearance Care</b> .....	489
Tire Terminology and Definitions .....	449	Cleaning the Inside of Your Vehicle .....	489
Inflation - Tire Pressure .....	452	Fabric/Carpet .....	491
High-Speed Operation .....	454	Leather .....	492
Tire Pressure Monitor System .....	455	Instrument Panel, Vinyl, and Other	
Tire Inspection and Rotation .....	460	Plastic Surfaces .....	492
When It Is Time for New Tires .....	462	Care of Safety Belts .....	493
Buying New Tires .....	462	Weatherstrips .....	493
Different Size Tires and Wheels .....	464	Washing Your Vehicle .....	493
Uniform Tire Quality Grading .....	465	Cleaning Exterior Lamps/Lenses .....	494
Wheel Alignment and Tire Balance .....	466	Finish Care .....	494
Wheel Replacement .....	467	Windshield, Backglass, and	
Tire Chains .....	468	Wiper Blades .....	495
Accessory Inflator .....	469	Aluminum Wheels .....	495
If a Tire Goes Flat .....	471	Tires .....	496
Changing a Flat Tire .....	472	Sheet Metal Damage .....	496
Removing the Spare Tire and Tools .....	473	Finish Damage .....	496
Removing the Flat Tire and Installing		Underbody Maintenance .....	497
the Spare Tire .....	477	Chemical Paint Spotting .....	497
Secondary Latch System .....	482	Vehicle Care/Appearance Materials .....	498

## Section 5 Service and Appearance Care

---

<b>Vehicle Identification</b> .....	499	Power Windows and Other Power	
Vehicle Identification Number (VIN) .....	499	Options .....	500
Service Parts Identification Label .....	499	Fuses and Circuit Breakers .....	501
<b>Electrical System</b> .....	500	Engine Compartment Fuse Block .....	501
Add-On Electrical Equipment .....	500	Rear Underseat Fuse Block .....	507
Headlamps .....	500	<b>Capacities and Specifications</b> .....	510
Windshield Wiper Fuses .....	500		

## Service

Your dealer knows your vehicle best and wants you to be happy with it. We hope you will go to your dealer for all your service needs. You will get genuine GM parts and GM-trained and supported service people.

We hope you will want to keep your GM vehicle all GM. Genuine GM parts have one of these marks:

***ACDelco***

---

**GM Parts**

---

**GM  
Goodwrench**

---

**GM Accessories**

## Accessories and Modifications

When you add non-GM accessories to your vehicle they can affect your vehicle's performance and safety, including such things as, airbags, braking, stability, ride and handling, emissions systems, aerodynamics, durability, and electronic systems like anti-lock brakes, traction control and stability control. Some of these accessories may even cause malfunction or damage not covered by warranty.

GM Accessories are designed to complement and function with other systems on your vehicle. Your GM dealer can accessorize your vehicle using genuine GM Accessories. When you go to your GM dealer and ask for GM Accessories, you will know that GM-trained and supported service technicians will perform the work using genuine GM Accessories.

## California Proposition 65 Warning

Most motor vehicles, including this one, contain and/or emit chemicals known to the State of California to cause cancer and birth defects or other reproductive harm. Engine exhaust, many parts and systems (including some inside the vehicle), many fluids, and some component wear by-products contain and/or emit these chemicals.

## Doing Your Own Service Work

### CAUTION:

**You can be injured and your vehicle could be damaged if you try to do service work on a vehicle without knowing enough about it.**

- **Be sure you have sufficient knowledge, experience, the proper replacement parts, and tools before you attempt any vehicle maintenance task.**

**CAUTION: (Continued)**

### **CAUTION: (Continued)**

- **Be sure to use the proper nuts, bolts, and other fasteners. English and metric fasteners can be easily confused. If you use the wrong fasteners, parts can later break or fall off. You could be hurt.**

If you want to do some of your own service work, you will want to use the proper service manual. It tells you much more about how to service your vehicle than this manual can. To order the proper service manual, see *Service Publications Ordering Information on page 555*.

Your vehicle has an airbag system. Before attempting to do your own service work, see *Servicing Your Airbag-Equipped Vehicle on page 88*.

You should keep a record with all parts receipts and list the mileage and the date of any service work you perform. See *Maintenance Record on page 532*.

## Adding Equipment to the Outside of Your Vehicle

Things you might add to the outside of your vehicle can affect the airflow around it. This may cause wind noise and affect windshield washer performance. Check with your dealer before adding equipment to the outside of your vehicle.

## Fuel

Use of the recommended fuel is an important part of the proper maintenance of your vehicle. To help keep your engine clean and maintain optimum vehicle performance, GM recommends the use of gasoline advertised as TOP TIER Detergent Gasoline.

The 8th digit of your Vehicle Identification Number (VIN) shows the code letter or number that identifies your engine. You will find the VIN at the top left of the instrument panel. See *Vehicle Identification Number (VIN) on page 499*.

## Gasoline Octane

If your vehicle has the 4.2L L6 engine (VIN Code S) or the 5.3L V8 engine (VIN Code M), use regular unleaded gasoline with a posted octane rating of 87 or higher. If the octane rating is less than 87, you may notice an audible knocking noise when you drive, commonly referred to as spark knock. If this occurs, use a gasoline rated at 87 octane or higher as soon as possible. If you are using gasoline rated at 87 octane or higher and you hear heavy knocking, your engine needs service.

If your vehicle has the 6.0L V8 engine (VIN Code H), use premium unleaded gasoline with a posted octane rating of 91 or higher. You may also use regular unleaded gasoline rated at 87 octane or higher, but your vehicle's acceleration may be slightly reduced, and you may notice a slight audible knocking noise, commonly referred to as spark knock. If the octane is less than 87, you may notice a heavy knocking noise when you drive. If this occurs, use a gasoline rated at 87 octane or higher as soon as possible. Otherwise, you might damage your engine. If you are using gasoline rated at 87 octane or higher and you hear heavy knocking, your engine needs service.



## Gasoline Specifications

At a minimum, gasoline should meet ASTM specification D 4814 in the United States or CAN/CGSB-3.5 in Canada. Some gasolines may contain an octane-enhancing additive called methylcyclopentadienyl manganese tricarbonyl (MMT). General Motors recommends against the use of gasolines containing MMT. See *Additives on page 385* for additional information.

## California Fuel

If your vehicle is certified to meet California Emissions Standards, it is designed to operate on fuels that meet California specifications. See the underhood emission control label. If this fuel is not available in states adopting California emissions standards, your vehicle will operate satisfactorily on fuels meeting federal specifications, but emission control system performance may be affected. The malfunction indicator lamp may turn on and your vehicle may fail a smog-check test. See *Malfunction Indicator Lamp on page 208*. If this occurs, return to your authorized GM dealer for diagnosis.

If it is determined that the condition is caused by the type of fuel used, repairs may not be covered by your warranty.

## Additives

To provide cleaner air, all gasolines in the United States are now required to contain additives that will help prevent engine and fuel system deposits from forming, allowing your emission control system to work properly. In most cases, you should not have to add anything to your fuel. However, some gasolines contain only the minimum amount of additive required to meet U.S. Environmental Protection Agency regulations. To help keep fuel injectors and intake valves clean, or if your vehicle experiences problems due to dirty injectors or valves, look for gasoline that is advertised as TOP TIER Detergent Gasoline. Also, your GM dealer has additives that will help correct and prevent most deposit-related problems.

Gasolines containing oxygenates, such as ethers and ethanol, and reformulated gasolines may be available in your area. General Motors recommends that you use these gasolines if they comply with the specifications described earlier. However, E85 (85% ethanol) and other fuels containing more than 10% ethanol must not be used in vehicles that were not designed for those fuels.

**Notice: Your vehicle was not designed for fuel that contains methanol. Do not use fuel containing methanol. It can corrode metal parts in your fuel system and also damage the plastic and rubber parts. That damage would not be covered under your warranty.**

Some gasolines that are not reformulated for low emissions may contain an octane-enhancing additive called methylcyclopentadienyl manganese tricarbonyl (MMT); ask the attendant where you buy gasoline whether the fuel contains MMT.

General Motors recommends against the use of such gasolines. Fuels containing MMT can reduce the life of spark plugs and the performance of the emission control system may be affected. The malfunction indicator lamp may turn on. If this occurs, return to your authorized GM dealer for service.

## Fuels in Foreign Countries

If you plan on driving in another country outside the United States or Canada, the proper fuel may be hard to find. Never use leaded gasoline or any other fuel not recommended in the previous text on fuel. Costly repairs caused by use of improper fuel would not be covered by your warranty.

To check the fuel availability, ask an auto club, or contact a major oil company that does business in the country where you will be driving.

## Filling the Tank

### CAUTION:

Fuel vapor burns violently and a fuel fire can cause bad injuries. To help avoid injuries to you and others, read and follow all the instructions on the pump island. Turn off your engine when you are refueling. Do not smoke if you are near fuel or refueling your vehicle. Keep sparks, flames, and smoking materials away from fuel. Do not leave the fuel pump unattended when refueling your vehicle. This is against the law in some places. Keep children away from the fuel pump; never let children pump fuel.

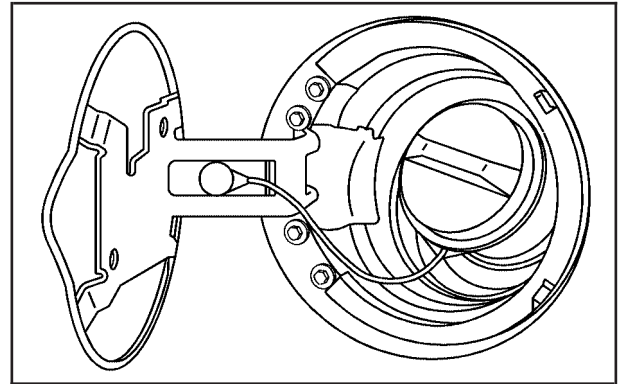

The tethered fuel cap is located behind a hinged fuel door on the driver's side of the vehicle.

To remove the fuel cap, turn it slowly counterclockwise.

While refueling, hang the tethered fuel cap from the hook on the fuel door.

 **CAUTION:**

**If you spill fuel and then something ignites it, you could be badly burned. Fuel can spray out on you if you open the fuel cap too quickly. This spray can happen if your tank is nearly full, and is more likely in hot weather. Open the fuel cap slowly and wait for any hiss noise to stop. Then unscrew the cap all the way.**

Be careful not to spill fuel. Do not top off or overfill the tank and wait a few seconds after you have finished pumping before removing the nozzle. Clean fuel from painted surfaces as soon as possible. See *Washing Your Vehicle* on page 493.

When replacing the fuel cap, turn it clockwise until it clicks. Make sure the cap is fully installed. The diagnostic system can determine if the fuel cap has been left off or improperly installed. This would allow fuel to evaporate into the atmosphere. See *Malfunction Indicator Lamp* on page 208.

There may also be a light that comes on in the instrument panel to let you know if your gas cap is not properly installed. See *Check Gas Cap Light on page 215* for more information.

 **CAUTION:**

If a fire starts while you are refueling, do not remove the nozzle. Shut off the flow of fuel by shutting off the pump or by notifying the station attendant. Leave the area immediately.

**Notice:** If you need a new fuel cap, be sure to get the right type. Your dealer can get one for you. If you get the wrong type, it may not fit properly. This may cause your malfunction indicator lamp to light and may damage your fuel tank and emissions system. See *Malfunction Indicator Lamp on page 208*.

## Filling a Portable Fuel Container

 **CAUTION:**

Never fill a portable fuel container while it is in your vehicle. Static electricity discharge from the container can ignite the gasoline vapor. You can be badly burned and your vehicle damaged if this occurs.

To help avoid injury to you and others:

- Dispense gasoline only into approved containers.
- Do not fill a container while it is inside a vehicle, in a vehicle's trunk, pickup bed, or on any surface other than the ground.
- Bring the fill nozzle in contact with the inside of the fill opening before operating the nozzle. Contact should be maintained until the filling is complete.
- Do not smoke while pumping gasoline.

## Checking Things Under the Hood

### CAUTION:

Things that burn can get on hot engine parts and start a fire. These include liquids like fuel, oil, coolant, brake fluid, windshield washer and other fluids, and plastic or rubber. You or others could be burned. Be careful not to drop or spill things that will burn onto a hot engine.

## Hood Release

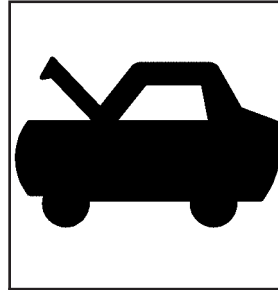

1. To open the hood, first pull the handle with this symbol on it. It is located inside the vehicle under the instrument panel on the driver's side.

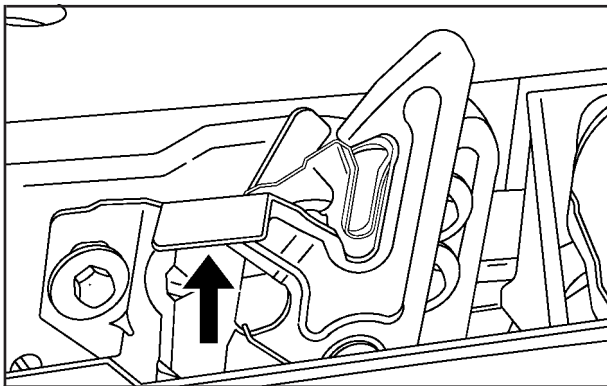

2. Then go to the front of the vehicle and release the secondary hood release.
3. Lift the hood, release the prop rod from its retainer and put the prop rod into the slot in the hood.

Before closing the hood, be sure all the filler caps are on properly. Then lift the hood to relieve pressure on the prop rod. Remove the prop rod from its slot in the hood and return the prop to its retainer. Lower the hood 6 to 8 inches (15 to 20 cm) above the vehicle and release it to latch fully. Check to make sure the hood is closed and repeat the process if necessary.

## Engine Compartment Overview

When you open the hood on the 4.2L L6 engine, here is what you will see:

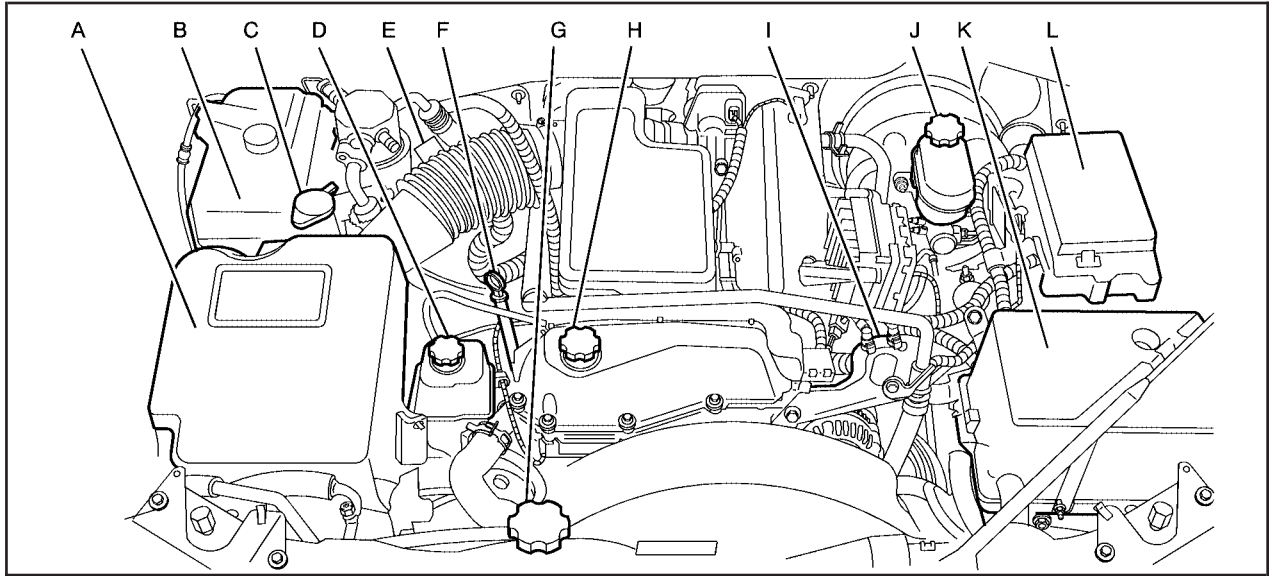



- A. Engine Air Cleaner/Filter. See *Engine Air Cleaner/Filter on page 406.*
- B. Engine Coolant Recovery Tank. See *Cooling System on page 416.*
- C. Windshield Washer Fluid Reservoir. See “Adding Washer Fluid” under *Windshield Washer Fluid on page 423.*
- D. Power Steering Fluid Reservoir. See *Power Steering Fluid on page 422.*
- E. Automatic Transmission Fluid Dipstick (Out of View). See “Checking the Fluid Level” under *Automatic Transmission Fluid on page 407.*
- F. Engine Oil Dipstick. See “Checking Engine Oil” under *Engine Oil on page 398.*
- G. Radiator Pressure Cap. See *Radiator Pressure Cap on page 414.*
- H. Engine Oil Fill Cap. See “When to Add Engine Oil” under *Engine Oil on page 398.*
- I. Remote Negative (–) Terminal (Marked GND). See *Jump Starting on page 429.*
- J. Brake Master Cylinder Reservoir. See “Brake Fluid” under *Brakes on page 424.*
- K. Battery. See *Battery on page 428.*
- L. Engine Compartment Fuse Block. See *Engine Compartment Fuse Block on page 501.*

When you open the hood on the 5.3L V8 engine, here is what you will see:

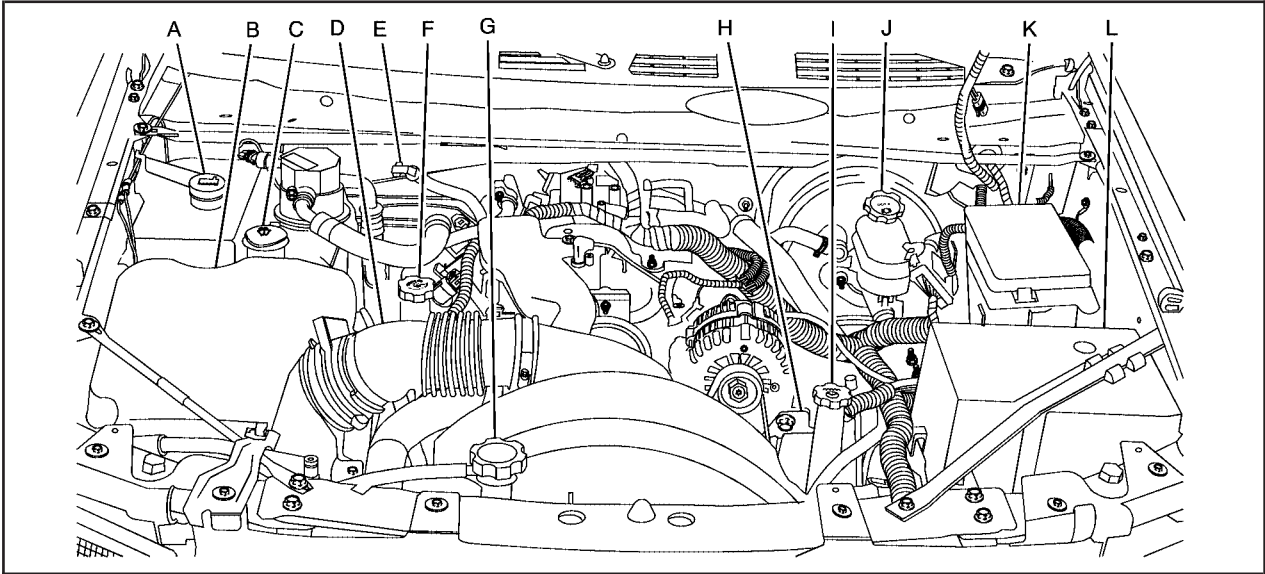

- A. Engine Coolant Recovery Tank. See *Cooling System on page 416*.
- B. Engine Air Cleaner/Filter. See *Engine Air Cleaner/Filter on page 406*.
- C. Windshield Washer Fluid Reservoir. See “Adding Washer Fluid” under *Windshield Washer Fluid on page 423*.
- D. Engine Oil Dipstick. See “Checking Engine Oil” under *Engine Oil on page 398*.
- E. Automatic Transmission Fluid Dipstick. See “Checking the Fluid Level” under *Automatic Transmission Fluid on page 407*.
- F. Engine Oil Fill Cap. See “When to Add Engine Oil” under *Engine Oil on page 398*.
- G. Radiator Pressure Cap. See *Radiator Pressure Cap on page 414*.
- H. Remote Negative (–) Terminal (Marked GND). See *Jump Starting on page 429*.
  - I. Power Steering Fluid Reservoir. See *Power Steering Fluid on page 422*.
  - J. Brake Master Cylinder Reservoir. See “Brake Fluid” under *Brakes on page 424*.
- K. Engine Compartment Fuse Block. See *Engine Compartment Fuse Block on page 501*.
- L. Battery. See *Battery on page 428*.

When you open the hood on the 6.0L V8 TrailBlazer SS engine, here is what you will see:

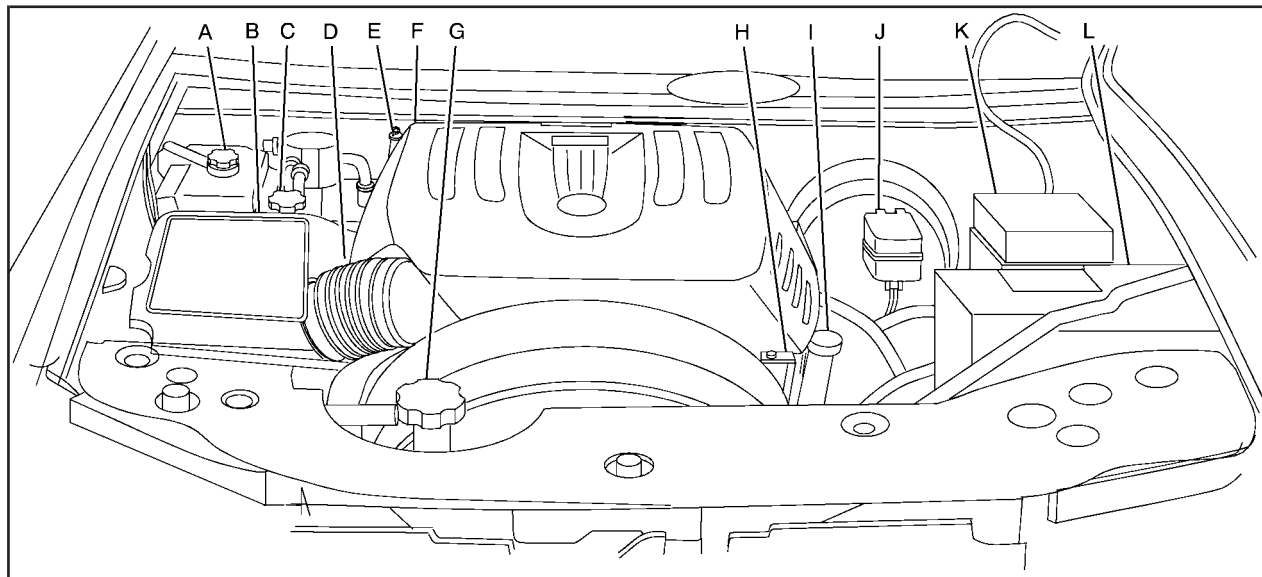

- A. Engine Coolant Recovery Tank. See *Cooling System on page 416*.
- B. Engine Air Cleaner/Filter. See *Engine Air Cleaner/Filter on page 406*.
- C. Windshield Washer Fluid Reservoir. See “Adding Washer Fluid” under *Windshield Washer Fluid on page 423*.
- D. Engine Oil Dipstick (Out of View). See “Checking Engine Oil” under *Engine Oil on page 398*.
- E. Automatic Transmission Fluid Dipstick. See “Checking the Fluid Level” under *Automatic Transmission Fluid on page 407*.
- F. Engine Oil Fill Cap (Under Engine Cover). See “When to Add Engine Oil” under *Engine Oil on page 398*.
- G. Radiator Pressure Cap. See *Radiator Pressure Cap on page 414*.
- H. Remote Negative (–) Terminal (Marked GND). See *Jump Starting on page 429*.
  - I. Power Steering Fluid Reservoir. See *Power Steering Fluid on page 422*.
  - J. Brake Master Cylinder Reservoir. See “Brake Fluid” under *Brakes on page 424*.
- K. Engine Compartment Fuse Block. See *Engine Compartment Fuse Block on page 501*.
- L. Battery. See *Battery on page 428*.

# Engine Oil

## Checking Engine Oil

It is a good idea to check the engine oil every time you get fuel. In order to get an accurate reading, the oil must be warm and the vehicle must be on level ground.

The engine oil dipstick handle is a yellow loop. See *Engine Compartment Overview on page 392* for the location of the engine oil dipstick.

1. Turn off the engine and give the oil several minutes to drain back into the oil pan. If you do not do this, the oil dipstick might not show the actual level.
2. Pull out the dipstick and clean it with a paper towel or cloth, then push it back in all the way. Remove it again, keeping the tip down, and check the level.

## When to Add Engine Oil

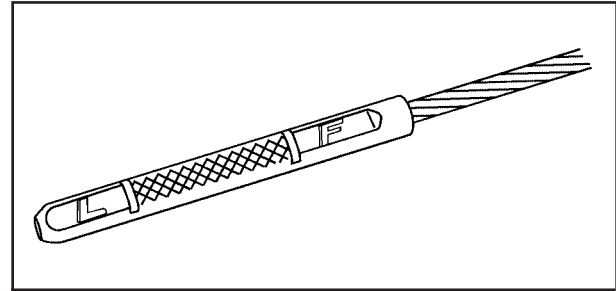

**L6 Engine**

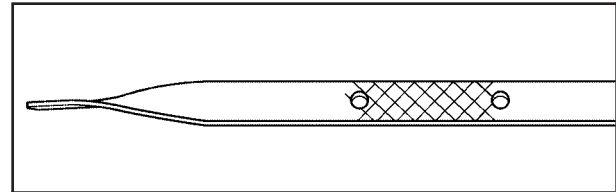

**V8 Engine**

If the oil is below the L mark for the L6 engine or the cross-hatched area at the tip of the dipstick for the V8 engine, you will need to add at least one quart/liter of oil. But you must use the right kind.

This section explains what kind of oil to use. For engine oil crankcase capacity, see *Capacities and Specifications on page 510*.

**Notice:** Do not add too much oil. If the engine has so much oil that the oil level gets above the cross-hatched area (F) that shows the proper operating range for the L6 engine or above the cross-hatched area for the V8 engine, the engine could be damaged.

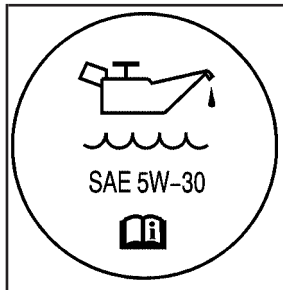

Except 6.0L V8  
(VIN Code H) Engine

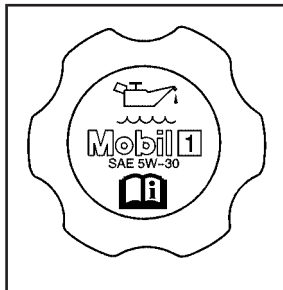

6.0L V8 (VIN Code H)  
Engine

See *Engine Compartment Overview on page 392* for the location of the engine oil fill cap.

Be sure to add enough oil to put the level somewhere in the proper operating range. Push the dipstick all the way back in when you are through.

### SS Model Only

Remove the engine cover for access to the engine oil fill cap as follows:

1. Undo the screw in the middle of the cover.
2. Pop the cover off of the stud on the driver's side.
3. Angle the cover up and pull it off of the bracket.
4. Reverse above steps to reinstall the cover.

## What Kind of Engine Oil to Use Except Vehicles with 6.0L V8 (VIN Code H) Engine

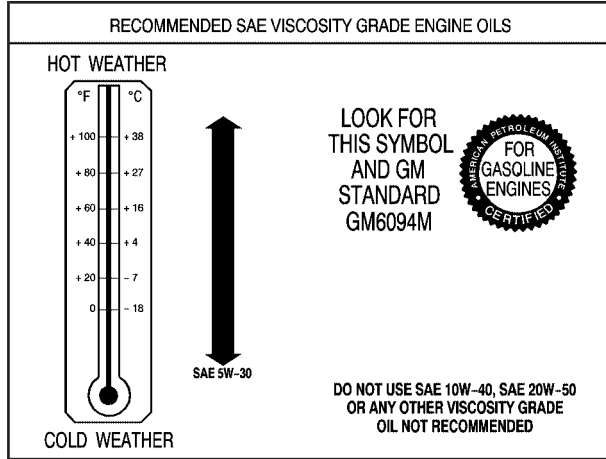

Look for two things:

- GM6094M

Your vehicle's engine requires oil meeting GM Standard GM6094M. You should look for and use only an oil that meets GM Standard GM6094M.

- SAE 5W-30

As shown in the viscosity chart, SAE 5W-30 is best for your vehicle.

These numbers on an oil container show its viscosity, or thickness. Do not use other viscosity oils such as SAE 20W-50.





You should look for this information on the oil container, and use only those oils that are identified as meeting GM Standard GM6094M and have the starburst symbol on the front of the oil container.

Oils meeting these requirements should also have the starburst symbol on the container. This symbol indicates that the oil has been certified by the American Petroleum Institute (API).

**Notice:** Use only engine oil identified as meeting GM Standard GM6094M and showing the American Petroleum Institute Certified For Gasoline Engines starburst symbol. Failure to use the recommended oil can result in engine damage not covered by your warranty.

GM Goodwrench<sup>®</sup> oil meets all the requirements for your vehicle.

If you are in an area of extreme cold, where the temperature falls below  $-20^{\circ}\text{F}$  ( $-29^{\circ}\text{C}$ ), it is recommended that you use either an SAE 5W-30 synthetic oil or an SAE 0W-30 oil. Both will provide easier cold starting and better protection for the engine at extremely low temperatures.

## For 6.0L V8 (VIN Code H) Engine Vehicles Only

RECOMMENDED SAE VISCOSITY GRADE ENGINE OILS

HOT WEATHER

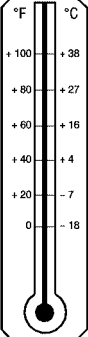

LOOK FOR THIS SYMBOL AND GM STANDARD GM4718M



SAE 5W-30

DO NOT USE SAE 10W-40, SAE 20W-50 OR ANY OTHER VISCOSITY GRADE OIL NOT RECOMMENDED

COLD WEATHER

Look for two things:

- GM4718M

Your vehicle's engine requires a special oil meeting GM Standard GM4718M. Oils meeting this standard may be identified as synthetic. However, not all synthetic oils will meet this GM standard. You should look for and use only an oil that meets GM Standard GM4718M.

**Notice:** If you use oils that do not have the GM4718M Standard designation, you can cause engine damage not covered by your warranty.

- SAE 5W-30

As shown in the viscosity chart, SAE 5W-30 is best for your vehicle.

These numbers on an oil container show its viscosity, or thickness. Do not use other viscosity oils such as SAE 20W-50.



Oils meeting these requirements should also have the starburst symbol on the container. This symbol indicates that the oil has been certified by the American Petroleum Institute (API).

You should look for this on the oil container, and use only those oils that are identified as meeting GM Standard GM4718M and have the starburst symbol on the front of the oil container.

Your vehicle's engine is filled at the factory with a Mobil 1<sup>®</sup> synthetic oil, which meets all requirements for your vehicle.

**Substitute Engine Oil:** When adding oil to maintain engine oil level, oil meeting GM Standard GM4718M may not be available. You can add substitute oil designated SAE 5W-30 with the starburst symbol at all temperatures. Substitute oil not meeting GM Standard GM4718M should not be used for an oil change.

### **Engine Oil Additives**

Do not add anything to the oil. The recommended oils with the starburst symbol that meet GM standards are all you will need for good performance and engine protection.

# Engine Oil Life System

## When to Change Engine Oil

Your vehicle has a computer system that lets you know when to change the engine oil and filter. This is based on engine revolutions and engine temperature, and not on mileage. Based on driving conditions, the mileage at which an oil change will be indicated can vary considerably. For the oil life system to work properly, you must reset the system every time the oil is changed.

When the system has calculated that oil life has been diminished, it will indicate that an oil change is necessary. A change engine oil light will come on, and, if your vehicle has a Driver Information Center (DIC), a CHANGE ENGINE OIL message will come. See *Change Engine Oil Light on page 212* and *DIC Warnings and Messages on page 220*.

Change your oil as soon as possible within the next 600 miles (1 000 km). It is possible that, if you are driving under the best conditions, the oil life system may not indicate that an oil change is necessary for over a year. However, the engine oil and filter must be changed at least once a year and at this time the system must be reset.

Your dealer has GM-trained people who will perform this work using genuine GM parts and reset the system. It is also important to check the oil regularly and keep it at the proper level.

If the system is ever reset accidentally, you must change your oil at 3,000 miles (5 000 km) since the last oil change. Remember to reset the oil life system whenever the oil is changed.

## How to Reset the Engine Oil Life System

The Engine Oil Life System calculates when to change your engine oil and filter based on vehicle use. Anytime your oil is changed, reset the system so it can calculate when the next oil change is required. If a situation occurs where you change your oil prior to a change engine oil light or CHANGE ENGINE OIL message being turned on, reset the system.

To reset the Engine Oil Life System, do the following:

1. Turn the ignition key to RUN with the engine off.
2. Fully press and release the accelerator pedal slowly three times within five seconds.

The change engine oil light will flash while the system is resetting.

3. When the light stops flashing, turn the key to LOCK.

If the light/message comes back on when you start the vehicle, the engine oil life system has not reset. Repeat the procedure.

## What to Do with Used Oil

Used engine oil contains certain elements that may be unhealthy for your skin and could even cause cancer. Do not let used oil stay on your skin for very long. Clean your skin and nails with soap and water, or a good hand cleaner. Wash or properly dispose of clothing or rags containing used engine oil. See the manufacturer's warnings about the use and disposal of oil products.

Used oil can be a threat to the environment. If you change your own oil, be sure to drain all the oil from the filter before disposal. Never dispose of oil by putting it in the trash, pouring it on the ground, into sewers, or into streams or bodies of water. Instead, recycle it by taking it to a place that collects used oil. If you have a problem properly disposing of your used oil, ask your dealer, a service station, or a local recycling center for help.

## Engine Air Cleaner/Filter

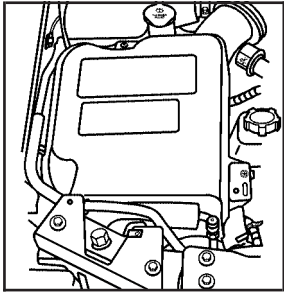

4.2L L6 Engine shown,  
5.3L and 6.0L V8  
Engines similar

See *Engine Compartment Overview* on page 392 for the location of the engine air cleaner/filter.

## When to Inspect the Engine Air Cleaner/Filter

Inspect the air cleaner/filter at the Maintenance II intervals and replace at the first oil change after each 50,000 mile (83 000 km) interval. See *Scheduled Maintenance* on page 517 for more information. If you are driving in dusty/dirty conditions, inspect the filter at each engine oil change.

## How to Inspect the Engine Air Cleaner/Filter

To inspect the air cleaner/filter remove the filter from the vehicle and lightly shake the filter to release loose dust and dirt. If the filter remains caked with dirt, a new filter is required.

To inspect or replace the engine air cleaner/filter, do the following:

1. Remove the screws on the engine air cleaner/filter and lift off the cover.
2. Remove the air cleaner/filter from the housing. Care should be taken to dislodge as little dirt as possible.
3. Inspect or replace the engine air cleaner/filter.
4. Reinstall the cover and tighten the screws.

 **CAUTION:**

Operating the engine with the air cleaner/filter off can cause you or others to be burned. The air cleaner not only cleans the air; it helps to stop flames if the engine backfires. If it is not there and the engine backfires, you could be burned. Do not drive with it off, and be careful working on the engine with the air cleaner/filter off.

**Notice:** If the air cleaner/filter is off, a backfire can cause a damaging engine fire. And, dirt can easily get into your engine, which will damage it. Always have the air cleaner/filter in place when you are driving.

## Automatic Transmission Fluid

### When to Check and Change Automatic Transmission Fluid

A good time to check your automatic transmission fluid level is when the engine oil is changed.

Change the fluid and filter at the intervals listed in *Additional Required Services on page 520*, and be sure to use the transmission fluid listed in *Recommended Fluids and Lubricants on page 527*.

### How to Check Automatic Transmission Fluid

Because this operation can be a little difficult, you may choose to have this done at the dealership service department.

If you do it yourself, be sure to follow all the instructions here, or you could get a false reading on the dipstick.

**Notice:** Too much or too little fluid can damage your transmission. Too much can mean that some of the fluid could come out and fall on hot engine parts or exhaust system parts, starting a fire. Too little fluid could cause the transmission to overheat. Be sure to get an accurate reading if you check your transmission fluid.

Wait at least 30 minutes before checking the transmission fluid level if you have been driving:

- When outside temperatures are above 90°F (32°C).
- At high speed for quite a while.
- In heavy traffic — especially in hot weather.
- While pulling a trailer.

To get the right reading, the fluid should be at normal operating temperature, which is 180°F to 200°F (82°C to 93°C).

Get the vehicle warmed up by driving about 15 miles (24 km) when outside temperatures are above 50°F (10°C). If it is colder than 50°F (10°C), drive the vehicle in THIRD (3) until the engine temperature gage moves and then remains steady for 10 minutes.

A cold fluid check can be made after the vehicle has been sitting for eight hours or more with the engine off, but this is used only as a reference.

Let the engine run at idle for five minutes if outside temperatures are 50°F (10°C) or more. If it is colder than 50°F (10°C), you may have to idle the engine longer. Should the fluid level be low during this cold check, you must check the fluid hot before adding fluid. Checking the fluid hot will give you a more accurate reading of the fluid level.

## Checking the Fluid Level

Prepare your vehicle as follows:

1. Park your vehicle on a level place. Keep the engine running.
2. With the parking brake applied, place the shift lever in PARK (P).
3. With your foot on the brake pedal, move the shift lever through each gear range, pausing for about three seconds in each range. Then, position the shift lever in PARK (P).
4. Let the engine run at idle for three minutes or more.



Then, without shutting off the engine, follow these steps:

1. Flip the handle up and then remove the dipstick and wipe it with a clean rag or paper towel.

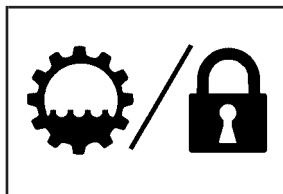

The automatic transmission dipstick handle with this symbol on it is located in the engine compartment on the passenger's side of the vehicle.

See *Engine Compartment Overview* on page 392 for more information on location.

2. Reinstall it back in all the way, wait three seconds and then pull it back out again. If the dipstick does not go down the tube easily, turn the blade and try again until it is fully inserted in the tube.

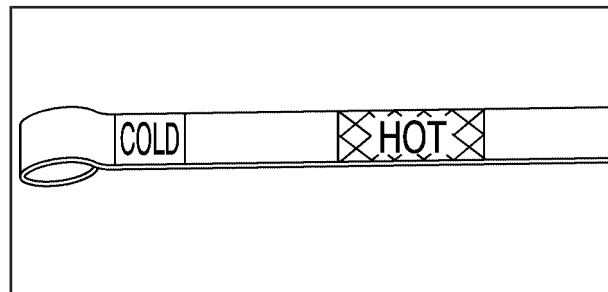

3. Check both sides of the dipstick, and read the lower level. The fluid level must be in the COLD area, below the cross-hatched area, for a cold check or in the HOT or cross-hatched area for a hot check. Be sure to keep the dipstick pointed down to get an accurate reading.
4. If the fluid level is in the acceptable range, reinstall the dipstick back in all the way; then flip the handle down to lock the dipstick in place.

## Consistency of Readings

Always check the fluid level at least twice using the procedure described previously. Consistency (repeatable readings) is important to maintaining proper fluid level. If inconsistent readings persist, contact your dealer.

## How to Add Automatic Transmission Fluid

Refer to the Maintenance Schedule to determine what kind of transmission fluid to use. See *Recommended Fluids and Lubricants on page 527*.

Add fluid only after checking the transmission fluid while it is hot. A cold check is used only as a reference. If the fluid level is low, add only enough of the proper fluid to bring the level up to the HOT area for a hot check. It does not take much fluid, generally less than one pint (0.5 L). Do not overfill.

**Notice:** Use of the incorrect automatic transmission fluid may damage your vehicle, and the damages may not be covered by your warranty. Always use the automatic transmission fluid listed in *Recommended Fluids and Lubricants on page 527*.

- After adding fluid, recheck the fluid level as described under “How to Check Automatic Transmission Fluid,” earlier in this section.
- When the correct fluid level is obtained, push the dipstick back in all the way; then flip the handle down to lock the dipstick in place.

## Engine Coolant

The cooling system in your vehicle is filled with DEX-COOL<sup>®</sup> engine coolant. This coolant is designed to remain in your vehicle for five years or 150,000 miles (240 000 km), whichever occurs first, if you add only DEX-COOL<sup>®</sup> extended life coolant.

The following explains your cooling system and how to add coolant when it is low. If you have a problem with engine overheating, see *Engine Overheating on page 414*.

A 50/50 mixture of clean, drinkable water and DEX-COOL<sup>®</sup> coolant will:

- Give freezing protection down to  $-34^{\circ}\text{F}$  ( $-37^{\circ}\text{C}$ ).
- Give boiling protection up to  $265^{\circ}\text{F}$  ( $129^{\circ}\text{C}$ ).

- Protect against rust and corrosion.
- Help keep the proper engine temperature.
- Let the warning lights and gages work as they should.

**Notice:** Using coolant other than DEX-COOL<sup>®</sup> may cause premature engine, heater core, or radiator corrosion. In addition, the engine coolant may require changing sooner, at the first maintenance service after each 30,000 miles (50 000 km) or 24 months, whichever occurs first. Any repairs would not be covered by your warranty. Always use DEX-COOL<sup>®</sup> (silicate-free) coolant in your vehicle.

## What to Use

Use a mixture of one-half clean, drinkable water and one-half DEX-COOL® coolant. If you use this coolant mixture, you do not need to add anything else.

### CAUTION:

Adding only plain water to your cooling system can be dangerous. Plain water, or some other liquid such as alcohol, can boil before the proper coolant mixture will. Your vehicle's coolant warning system is set for the proper coolant mixture. With plain water or the wrong mixture, your engine could get too hot but you would not get the overheat warning. Your engine could catch fire and you or others could be burned. Use a 50/50 mixture of clean, drinkable water and DEX-COOL® coolant.

**Notice:** If you use an improper coolant mixture, your engine could overheat and be badly damaged. The repair cost would not be covered by your warranty. Too much water in the mixture can freeze and crack the engine, radiator, heater core, and other parts.

If you have to add coolant more than four times a year, have your dealer check your cooling system.

**Notice:** If you use extra inhibitors and/or additives in your vehicle's cooling system, you could damage your vehicle. Use only the proper mixture of the engine coolant listed in this manual for the cooling system. See *Recommended Fluids and Lubricants* on page 527 for more information.

## Checking Coolant

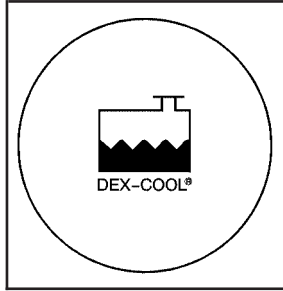

The engine coolant recovery tank is in the engine compartment on the passenger's side of the vehicle. The cap has this symbol on it. See *Engine Compartment Overview on page 392* for more information on location.

The vehicle must be on a level surface. When your engine is cold, the coolant level should be at FULL COLD, or a little higher.

## Adding Coolant

If you need more coolant, add the proper DEX-COOL<sup>®</sup> coolant mixture at the coolant recovery tank.

### CAUTION:

**Turning the radiator pressure cap when the engine and radiator are hot can allow steam and scalding liquids to blow out and burn you badly. With the coolant recovery tank, you will almost never have to add coolant at the radiator. Never turn the radiator pressure cap — even a little — when the engine and radiator are hot.**

Add coolant mixture at the recovery tank, but be careful not to spill it.

 **CAUTION:**

**You can be burned if you spill coolant on hot engine parts. Coolant contains ethylene glycol, and it will burn if the engine parts are hot enough. Do not spill coolant on a hot engine.**

Occasionally check the coolant level in the radiator. For information on how to add coolant to the radiator, see *Cooling System on page 416*.

## Radiator Pressure Cap

**Notice:** If the pressure cap is not tightly installed, coolant loss and possible engine damage may occur. Be sure the cap is properly and tightly secured.

See *Engine Compartment Overview on page 392* for information on location.

## Engine Overheating

You will find a coolant temperature gage on your vehicle's instrument panel. See *Engine Coolant Temperature Gage on page 207* for more information.

If your vehicle has a Driver Information Center (DIC), the display will show an Engine Coolant Hot/Engine Overheated message. See *DIC Warnings and Messages on page 220* for more information.

## If Steam Is Coming From Your Engine

### CAUTION:

**Steam from an overheated engine can burn you badly, even if you just open the hood. Stay away from the engine if you see or hear steam coming from it. Just turn it off and get everyone away from the vehicle until it cools down. Wait until there is no sign of steam or coolant before you open the hood.**

**If you keep driving when your engine is overheated, the liquids in it can catch fire. You or others could be badly burned. Stop your engine if it overheats, and get out of the vehicle until the engine is cool.**

**Notice:** If your engine catches fire because you keep driving with no coolant, your vehicle can be badly damaged. The costly repairs would not be covered by your warranty.

## If No Steam Is Coming From Your Engine

If you get an engine overheat warning but see or hear no steam, the problem may not be too serious. Sometimes the engine can get a little too hot when you:

- Climb a long hill on a hot day.
- Stop after high-speed driving.
- Idle for long periods in traffic.
- Tow a trailer.

If you get the overheat warning with no sign of steam, try this for a minute or so:

1. In heavy traffic, let the engine idle in NEUTRAL (N) while stopped. If it is safe to do so, pull off the road, shift to PARK (P) or NEUTRAL (N) and let the engine idle.
2. Turn on your heater to full hot at the highest fan speed and open the windows as necessary.

If you no longer have the overheat warning, you can drive. Just to be safe, drive slower for about 10 minutes. If the warning does not come back on, you can drive normally.

If the warning continues and you have not stopped, pull over, stop, and park your vehicle right away.

If there is still no sign of steam, you can push down the accelerator until the engine speed is about twice as fast as normal idle speed for at least three minutes while you are parked. If you still have the warning, turn off the engine and get everyone out of the vehicle until it cools down.

You may decide not to lift the hood but to get service help right away.

## Cooling System

When you decide it is safe to lift the hood, here is what you will see:

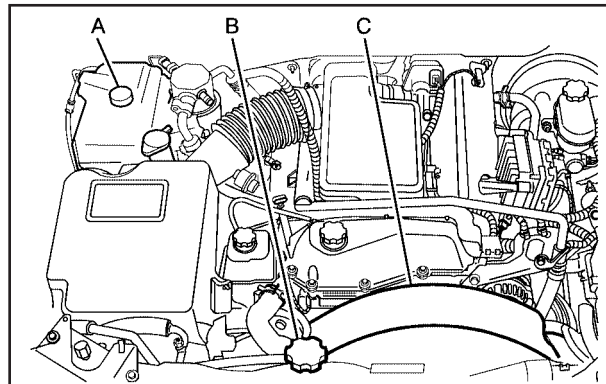

**4.2L L6 Engine**

- A. Coolant Recovery Tank
- B. Radiator Pressure Cap
- C. Engine Fan



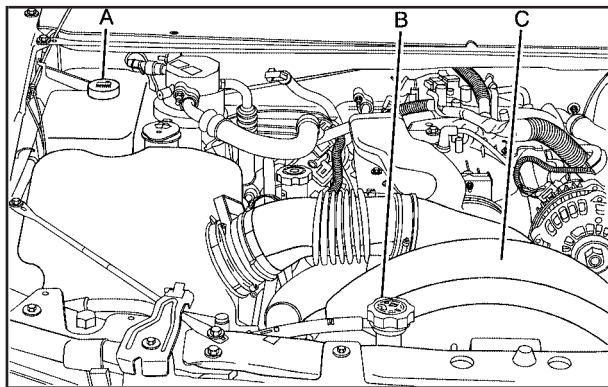

5.3L V8 Engine shown, 6.0L V8 Engine similar

- A. Coolant Recovery Tank
- B. Radiator Pressure Cap
- C. Engine Fan

If the coolant inside the coolant recovery tank is boiling, do not do anything else until it cools down. The vehicle should be parked on a level surface.

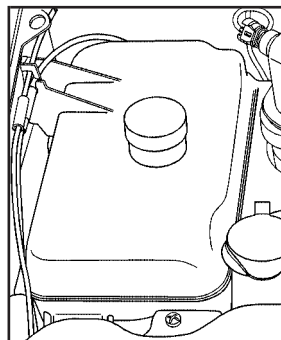

The coolant level should be at least up to the FULL COLD mark. If it is not, you may have a leak at the pressure cap or in the radiator hoses, heater hoses, radiator, water pump, or somewhere else in the cooling system.

**⚠ CAUTION:**

**Heater and radiator hoses, and other engine parts, can be very hot. Do not touch them. If you do, you can be burned.**

**Do not run the engine if there is a leak. If you run the engine, it could lose all coolant. That could cause an engine fire, and you could be burned. Get any leak fixed before you drive the vehicle.**

If there seems to be no leak, start the engine again. The engine cooling fan speed should increase when idle speed is doubled by pushing the accelerator pedal down. If it does not, your vehicle needs service. Turn off the engine.

**Notice:** Engine damage from running your engine without coolant is not covered by your warranty.

**Notice:** Using coolant other than DEX-COOL® may cause premature engine, heater core, or radiator corrosion. In addition, the engine coolant could require changing sooner, at 30,000 miles (50 000 km) or 24 months, whichever occurs first. Any repairs would not be covered by your warranty. Always use DEX-COOL® (silicate-free) coolant in your vehicle.

## How to Add Coolant to the Coolant Recovery Tank

If you have not found a problem yet, but the coolant level is not at the FULL COLD mark, add a 50/50 mixture of clean, drinkable water and DEX-COOL® engine coolant at the coolant recovery tank. See *Engine Coolant on page 411* for more information.

### CAUTION:

Adding only plain water to your cooling system can be dangerous. Plain water, or some other liquid such as alcohol, can boil before the proper coolant mixture will. Your vehicle's coolant warning system is set for the proper coolant mixture. With plain water or the wrong mixture, your engine could get too hot but you would not get the overheat warning. Your engine could catch fire and you or others could be burned. Use a 50/50 mixture of clean, drinkable water and DEX-COOL® coolant.

**Notice:** In cold weather, water can freeze and crack the engine, radiator, heater core and other parts. Use the recommended coolant and the proper coolant mixture.

 **CAUTION:**

You can be burned if you spill coolant on hot engine parts. Coolant contains ethylene glycol and it will burn if the engine parts are hot enough. Do not spill coolant on a hot engine.

When the coolant in the coolant recovery tank is at the FULL COLD mark, start your vehicle.

If the overheat warning continues, there is one more thing you can try. You can add the proper coolant mixture directly to the radiator, but be sure the cooling system is cool before you do it.

 **CAUTION:**

Steam and scalding liquids from a hot cooling system can blow out and burn you badly. They are under pressure, and if you turn the radiator pressure cap — even a little — they can come out at high speed. Never turn the cap when the cooling system, including the radiator pressure cap, is hot. Wait for the cooling system and radiator pressure cap to cool if you ever have to turn the pressure cap.

## How to Add Coolant to the Radiator

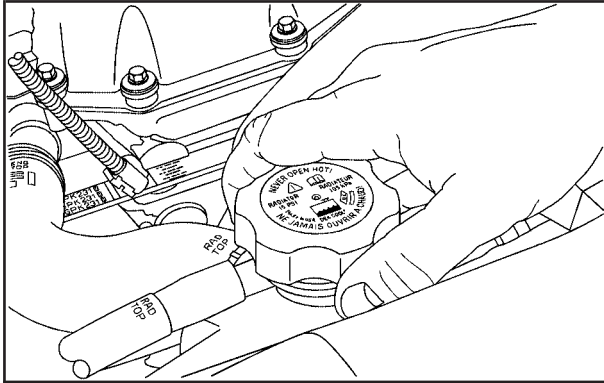

1. You can remove the radiator pressure cap when the cooling system, including the radiator pressure cap and upper radiator hose, is no longer hot.

Turn the pressure cap slowly counterclockwise about one full turn. If you hear a hiss, wait for that to stop. A hiss means there is still some pressure left.

2. Then keep turning the pressure cap. Remove the pressure cap.

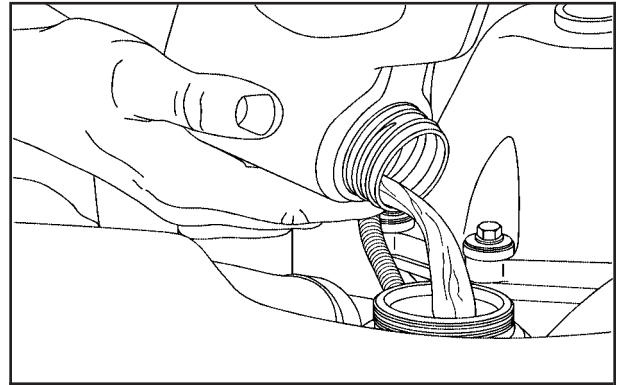

3. Fill the radiator with the proper DEX-COOL® coolant mixture, up to the base of the filler neck. See *Engine Coolant* on page 411 for more information about the proper coolant mixture.

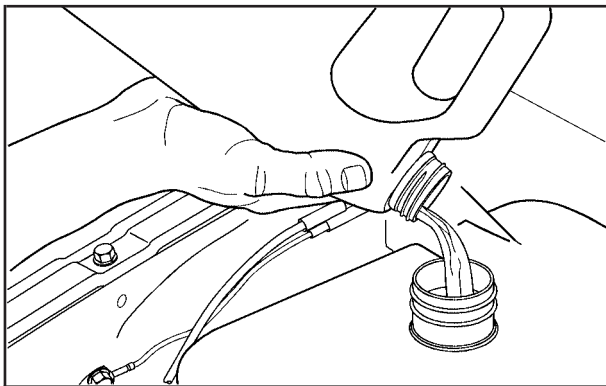

4. Then fill the coolant recovery tank to the **FULL COLD** mark.
5. Put the cap back on the coolant recovery tank, but leave the radiator pressure cap off.

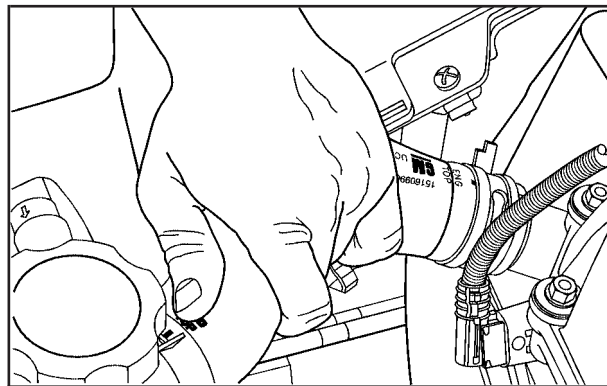

6. Start the engine and let it run until you can feel the upper radiator hose getting hot. Watch out for the engine cooling fan.
7. By this time, the coolant level inside the radiator filler neck may be lower. If the level is lower, add more of the proper DEX-COOL<sup>®</sup> coolant mixture through the filler neck until the level reaches the base of the filler neck.
8. Then replace the pressure cap. At any time during this procedure if coolant begins to flow out of the filler neck, reinstall the pressure cap. Be sure the pressure cap is hand-tight and fully seated.

## Engine Fan Noise

Your vehicle has a clutched engine cooling fan. When the clutch is engaged, the fan spins faster to provide more air to cool the engine. In most everyday driving conditions the clutch is not engaged. This improves fuel economy and reduces fan noise. Under heavy vehicle loading, trailer towing, and/or high outside temperatures, the fan speed increases when the clutch engages so you may hear an increase in fan noise. This is normal and should not be mistaken as the transmission slipping or making extra shifts. It is merely the cooling system functioning properly. The fan will slow down when additional cooling is not required and the clutch disengages.

You may also hear this fan noise when you start the engine. It will go away as the fan clutch disengages.

## Power Steering Fluid

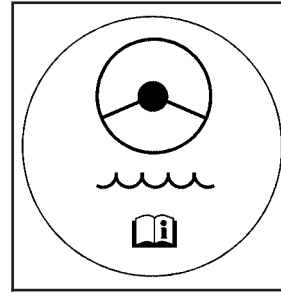

See *Engine Compartment Overview* on page 392 for reservoir location.

## When to Check Power Steering Fluid

It is not necessary to regularly check power steering fluid unless you suspect there is a leak in the system or you hear an unusual noise. A fluid loss in this system could indicate a problem. Have the system inspected and repaired.

## How to Check Power Steering Fluid

To check the power steering fluid, do the following:

1. Turn the key off and let the engine compartment cool down.
2. Wipe the cap and the top of the reservoir clean.
3. Unscrew the cap and wipe the dipstick with a clean rag.
4. Replace the cap and completely tighten it.
5. Remove the cap again and look at the fluid level on the dipstick.

For vehicles with the 4.2L L6 engine, the level should be at the C (Cold) mark. For vehicles with the 5.3L or 6.0L V8 engines, the level should be at the FULL mark. If necessary, add only enough fluid to bring the level up to the mark.

## What to Use

To determine what kind of fluid to use, see *Recommended Fluids and Lubricants on page 527*. Always use the proper fluid. Failure to use the proper fluid can cause leaks and damage hoses and seals.

## Windshield Washer Fluid

### What to Use

When you need windshield washer fluid, be sure to read the manufacturer's instructions before use. If you will be operating your vehicle in an area where the temperature may fall below freezing, use a fluid that has sufficient protection against freezing.

## Adding Washer Fluid

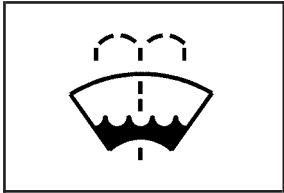

Open the cap with the washer symbol on it. Add washer fluid until the tank is full. See *Engine Compartment Overview on page 392* for reservoir location.

### Notice:

- **When using concentrated washer fluid, follow the manufacturer's instructions for adding water.**
- **Do not mix water with ready-to-use washer fluid. Water can cause the solution to freeze and damage your washer fluid tank and other parts of the washer system. Also, water does not clean as well as washer fluid.**
- **Fill your washer fluid tank only three-quarters full when it is very cold. This allows for expansion if freezing occurs, which could damage the tank if it is completely full.**
- **Do not use engine coolant (antifreeze) in your windshield washer. It can damage your washer system and paint.**

## Brakes

### Brake Fluid

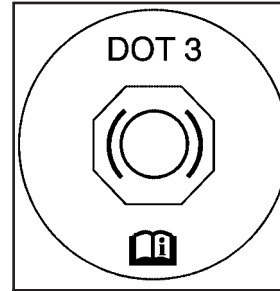

Your brake master cylinder reservoir is filled with DOT-3 brake fluid. See *Engine Compartment Overview on page 392* for the location of the reservoir.

There are only two reasons why the brake fluid level in the reservoir might go down. The first is that the brake fluid goes down to an acceptable level during normal brake lining wear. When new linings are put in, the fluid level goes back up. The other reason is that fluid is leaking out of the brake system. If it is, you should have your brake system fixed, since a leak means that sooner or later your brakes will not work well, or will not work at all.



So, it is not a good idea to top off your brake fluid. Adding brake fluid will not correct a leak. If you add fluid when your linings are worn, then you will have too much fluid when you get new brake linings. You should add or remove brake fluid, as necessary, only when work is done on the brake hydraulic system.

 **CAUTION:**

**If you have too much brake fluid, it can spill on the engine. The fluid will burn if the engine is hot enough. You or others could be burned, and your vehicle could be damaged. Add brake fluid only when work is done on the brake hydraulic system. See “Checking Brake Fluid” in this section.**

Refer to the Maintenance Schedule to determine when to check your brake fluid. See *Scheduled Maintenance* on page 517.

## Checking Brake Fluid

You can check the brake fluid without taking off the cap.

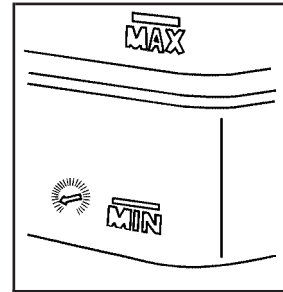

Look at the brake fluid reservoir. The fluid level should be above MIN. If it is not, have your brake system checked to see if there is a leak.

After work is done on the brake hydraulic system, make sure the level is above the MIN, but not over the MAX mark.

## What to Add

When you do need brake fluid, use only DOT-3 brake fluid. Use new brake fluid from a sealed container only. See *Recommended Fluids and Lubricants* on page 527.

Always clean the brake fluid reservoir cap and the area around the cap before removing it. This will help keep dirt from entering the reservoir.

 **CAUTION:**

**With the wrong kind of fluid in the brake system, the brakes may not work well, or they may not even work at all. This could cause a crash. Always use the proper brake fluid.**

**Notice:**

- **Using the wrong fluid can badly damage brake system parts. For example, just a few drops of mineral-based oil, such as engine oil, in the brake system can damage brake system parts so badly that they will have to be replaced. Do not let someone put in the wrong kind of fluid.**
- **If you spill brake fluid on your vehicle's painted surfaces, the paint finish can be damaged. Be careful not to spill brake fluid on your vehicle. If you do, wash it off immediately. See *Washing Your Vehicle* on page 493.**

## Brake Wear

Your vehicle has four-wheel disc brakes.

Disc brake pads have built-in wear indicators that make a high-pitched warning sound when the brake pads are worn and new pads are needed. The sound may come and go or be heard all the time your vehicle is moving, except when you are pushing on the brake pedal firmly.

 **CAUTION:**

**The brake wear warning sound means that soon the brakes will not work well. That could lead to an accident. When you hear the brake wear warning sound, have your vehicle serviced.**

**Notice: Continuing to drive with worn-out brake pads could result in costly brake repair.**

Some driving conditions or climates may cause a brake squeal when the brakes are first applied or lightly applied. This does not mean something is wrong with your brakes.

Properly torqued wheel nuts are necessary to help prevent brake pulsation. When tires are rotated, inspect brake pads for wear and evenly tighten wheel nuts in the proper sequence to GM torque specifications.

Brake linings should always be replaced as complete axle sets.

### **Brake Pedal Travel**

See your dealer if the brake pedal does not return to normal height, or if there is a rapid increase in pedal travel. This could be a sign of brake trouble.

### **Brake Adjustment**

Every time you make a brake stop, your disc brakes adjust for wear.

## **Replacing Brake System Parts**

The braking system on a vehicle is complex. Its many parts have to be of top quality and work well together if the vehicle is to have really good braking. Your vehicle was designed and tested with top-quality GM brake parts. When you replace parts of your braking system — for example, when your brake linings wear down and you need new ones put in — be sure you get new approved GM replacement parts. If you do not, your brakes may no longer work properly. For example, if someone puts in brake linings that are wrong for your vehicle, the balance between your front and rear brakes can change — for the worse. The braking performance you have come to expect can change in many other ways if someone puts in the wrong replacement brake parts.

## Battery

Your vehicle has a maintenance free battery. When it is time for a new battery, get one that has the replacement number shown on the original battery's label. We recommend an ACDelco® replacement battery. See *Engine Compartment Overview on page 392* for battery location.

**Warning:** Battery posts, terminals, and related accessories contain lead and lead compounds, chemicals known to the State of California to cause cancer and reproductive harm. Wash hands after handling.

## Vehicle Storage

If you are not going to drive your vehicle for 25 days or more, remove the black, negative (-) cable from the battery. This will help keep your battery from running down.

### CAUTION:

**Batteries have acid that can burn you and gas that can explode. You can be badly hurt if you are not careful. See *Jump Starting on page 429* for tips on working around a battery without getting hurt.**

## Jump Starting

If your vehicle's battery has run down, you may want to use another vehicle and some jumper cables to start your vehicle. Be sure to use the following steps to do it safely.

### CAUTION:

**Batteries can hurt you. They can be dangerous because:**

- They contain acid that can burn you.
- They contain gas that can explode or ignite.
- They contain enough electricity to burn you.

**If you do not follow these steps exactly, some or all of these things can hurt you.**

**Notice:** Ignoring these steps could result in costly damage to your vehicle that would not be covered by your warranty.

**Trying to start your vehicle by pushing or pulling it will not work, and it could damage your vehicle.**

1. Check the other vehicle. It must have a 12-volt battery with a negative ground system.

**Notice:** If the other vehicle's system is not a 12-volt system with a negative ground, both vehicles can be damaged. Only use vehicles with 12-volt systems with negative grounds to jump start your vehicle.

2. Get the vehicles close enough so the jumper cables can reach, but be sure the vehicles are not touching each other. If they are, it could cause a ground connection you do not want. You would not be able to start your vehicle, and the bad grounding could damage the electrical systems.

To avoid the possibility of the vehicles rolling, set the parking brake firmly on both vehicles involved in the jump start procedure. Put an automatic transmission in PARK (P) or a manual transmission in NEUTRAL before setting the parking brake. If you have a four-wheel-drive vehicle, be sure the transfer case is not in NEUTRAL.

**Notice:** If you leave your radio or other accessories on during the jump starting procedure, they could be damaged. The repairs would not be covered by your warranty. Always turn off your radio and other accessories when jump starting your vehicle.

3. Turn off the ignition on both vehicles.  
Unplug unnecessary accessories plugged into the cigarette lighter or the accessory power outlets, if equipped. Turn off the radio and all lamps that are not needed. This will avoid sparks and help to save both batteries. And it could save the radio!
4. Open both hoods and locate the batteries.  
Find the positive (+) and negative (-) terminals on each battery. Your vehicle has a remote negative (-) jump starting terminal. You should always use this remote terminal instead of the terminal on the battery.  
The remote negative (-) terminal is located on the front engine lift bracket on vehicles with the 4.2L L6 engine or the engine accessory drive bracket for vehicles with the 5.3L or 6.0L V8 engines, and is marked GND (Ground). See *Engine Compartment Overview* on page 392 for more information on location.

 **CAUTION:**

Using a match near a battery can cause battery gas to explode. People have been hurt doing this, and some have been blinded. Use a flashlight if you need more light.

Be sure the battery has enough water. You do not need to add water to the battery installed in your new vehicle. But if a battery has filler caps, be sure the right amount of fluid is there. If it is low, add water to take care of that first. If you do not, explosive gas could be present.

Battery fluid contains acid that can burn you. Do not get it on you. If you accidentally get it in your eyes or on your skin, flush the place with water and get medical help immediately.

**⚠ CAUTION:**

**Fans or other moving engine parts can injure you badly. Keep your hands away from moving parts once the engine is running.**

5. Check that the jumper cables do not have loose or missing insulation. If they do, you could get a shock. The vehicles could be damaged too.

Before you connect the cables, here are some basic things you should know. Positive (+) will go to positive (+) or to a remote positive (+) terminal if the vehicle has one. Negative (-) will go to a heavy, unpainted metal engine part or to a remote negative (-) terminal if the vehicle has one. Do not connect positive (+) to negative (-) or you will get a short that would damage the battery and maybe other parts too. And do not connect the negative (-) cable to the negative (-) terminal on the dead battery because this can cause sparks.

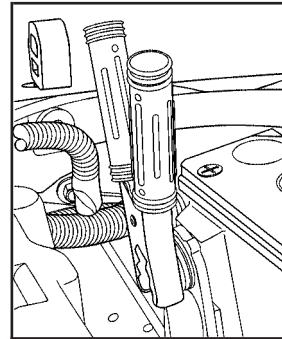

6. Connect the red positive (+) cable to the positive (+) terminal of the dead battery. Use a remote positive (+) terminal if the vehicle has one.

7. Do not let the other end touch metal. Connect it to the positive (+) terminal of the good battery. Use a remote positive (+) terminal if the vehicle has one.
8. Now connect the black negative (-) cable to the negative (-) terminal of the good battery. Use a remote negative (-) terminal if the vehicle has one.

Do not let the other end touch anything until the next step. The other end of the negative (-) cable does not go to the dead battery. It goes to a heavy, unpainted metal engine part or to the remote negative (-) terminal on the vehicle with the dead battery. Your vehicle has a remote negative (-) terminal, marked GND, for this purpose.

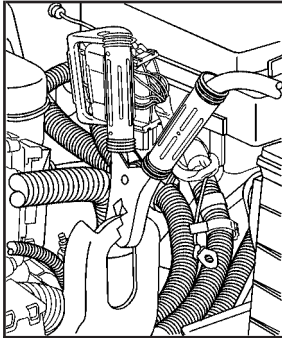

4.2L L6 Engine

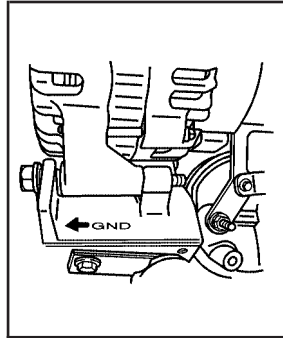

5.3L V8 Engine shown,  
6.0L V8 Engine  
similar

The remote negative (-) terminal is located on the front engine lift bracket for the 4.2L L6 engine, and on the accessory drive bracket for the 5.3L or 6.0L V8 engines.

9. Connect the other end of the negative (-) cable to the remote negative (-) terminal on the vehicle with the dead battery.
10. Now start the vehicle with the good battery and run the engine for a while.
11. Try to start the vehicle that had the dead battery. If it will not start after a few tries, it probably needs service.

**Notice:** If the jumper cables are connected or removed in the wrong order, electrical shorting may occur and damage the vehicle. The repairs would not be covered by your warranty. Always connect and remove the jumper cables in the correct order, making sure that the cables do not touch each other or other metal.



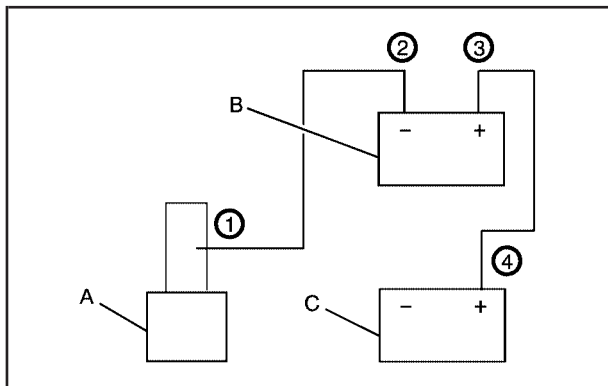

### Jumper Cable Removal

- A. Heavy, Unpainted Metal Engine Part or Remote Negative (-) Terminal
- B. Good Battery or Remote Positive (+) and Remote Negative (-) Terminals
- C. Dead Battery or Remote Positive (+) Terminal

To disconnect the jumper cables from both vehicles, do the following:

1. Disconnect the black negative (-) cable from the vehicle that had the dead battery.
2. Disconnect the black negative (-) cable from the vehicle with the good battery.
3. Disconnect the red positive (+) cable from the vehicle with the good battery.
4. Disconnect the red positive (+) cable from the other vehicle.

# All-Wheel Drive

## When to Check Lubricant

It is not necessary to regularly check fluid unless you suspect there is a leak or you hear an unusual noise. A fluid loss could indicate a problem. Have it inspected and repaired.

## How to Check Lubricant

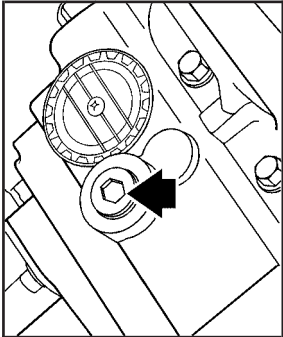

To get an accurate reading, the vehicle should be on a level surface.

If the level is below the bottom of the filler plug hole, located on the transfer case, you'll need to add some lubricant. Add enough lubricant to raise the level to the bottom of the filler plug hole. Use care not to overtighten the plug.

## What to Use

To determine what kind of lubricant to use, see *Recommended Fluids and Lubricants on page 527*.

# Rear Axle

## When to Check Lubricant

It is not necessary to regularly check rear axle fluid unless you suspect there is a leak or you hear an unusual noise. A fluid loss could indicate a problem. Have it inspected and repaired.

## How to Check Lubricant

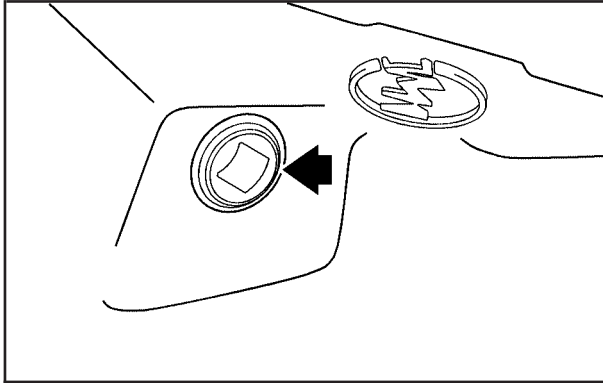

To get an accurate reading, the vehicle should be on a level surface.

The proper level is from 0 to 3/8 inch (0 to 10 mm) below the bottom of the filler plug hole, located on the rear axle.

For vehicles equipped with the SS package, the proper level is from 0.6 inch to 1.6 inches (15 mm to 40 mm) below the bottom of the filler plug hole, located on the rear axle. Add only enough fluid to reach the proper level.

## What to Use

To determine what kind of lubricant to use, see *Recommended Fluids and Lubricants on page 527*.

For vehicles equipped with the SS package, to add lubricant when the level is low, use SAE 75W-90 Synthetic Axle Lubricant (GM Part No. U.S. 12378261, in Canada 10953455) meeting GM Specification 9986115. To completely refill after draining, add 4 ounces (118 ml) of Limited-Slip Axle Lubricant Additive (GM Part No. U.S. 1052358, in Canada 992694). Then fill to the bottom of the filler plug hole with the Synthetic Gear Lubricant.

## Four-Wheel Drive

### Transfer Case

### When to Check Lubricant

It is not necessary to regularly check fluid unless you suspect there is a leak or you hear an unusual noise. A fluid loss could indicate a problem. Have it inspected and repaired.

## How to Check Lubricant

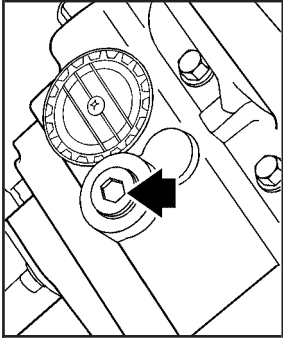

To get an accurate reading, the vehicle should be on a level surface.

If the level is below the bottom of the filler plug hole, you'll need to add some lubricant. Add enough lubricant to raise the level to the bottom of the filler plug hole. Use care not to overtighten the plug.

### What to Use

To determine what kind of lubricant to use, see *Recommended Fluids and Lubricants on page 527*.

## Front Axle

### When to Check Lubricant

It is not necessary to regularly check front axle fluid unless you suspect there is a leak or you hear an unusual noise. A fluid loss could indicate a problem. Have it inspected and repaired.

### How to Check Lubricant

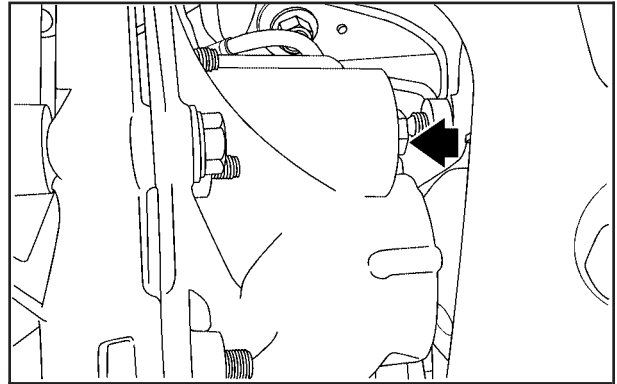

To get an accurate reading, the vehicle should be on a level surface.

If the level is below the bottom of the filler plug hole, located on the front axle, you may need to add some lubricant.

When the differential is cold, add enough lubricant to raise the level to 1/2 inch (12 mm) below the filler plug hole.

When the differential is at operating temperature (warm), add enough lubricant to raise the level to the bottom of the filler plug hole.

## What to Use

To determine what kind of lubricant to use, see *Recommended Fluids and Lubricants on page 527*.

## Bulb Replacement

For the proper type of replacement bulbs, see *Replacement Bulbs on page 439*.

For any bulb changing procedure not listed in this section, contact your dealer.

## Halogen Bulbs

### CAUTION:

**Halogen bulbs have pressurized gas inside and can burst if you drop or scratch the bulb. You or others could be injured. Be sure to read and follow the instructions on the bulb package.**

## Taillamps and Turn Signal Lamps

1. Open the liftgate. See *Liftgate/Liftglass* on page 106 for more information.

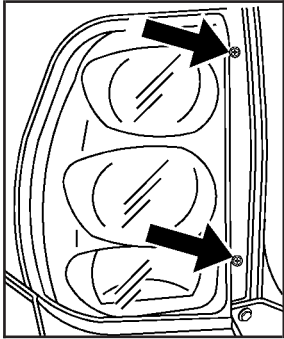

2. Remove the two screws from the taillamp assembly.

3. Pull the taillamp assembly away from the vehicle.

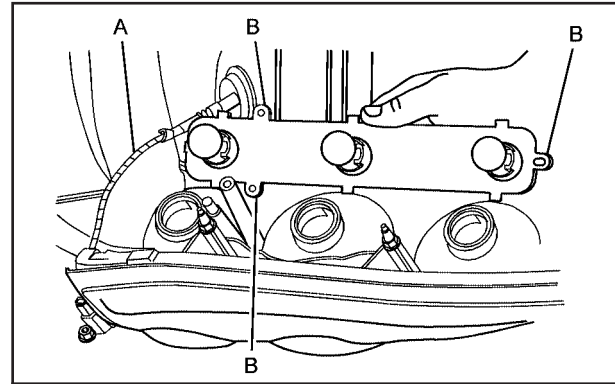

4. Unclip the wiring harness (A) and remove the three retaining screws (B) from the socket plate.
5. Remove the socket plate.
6. Holding the socket, pull the bulb to release it from the socket.
7. Push the new bulb into the socket until it clicks.
8. Reinstall the socket and tighten the three screws.
9. Reconnect the wiring harness.
10. Reinstall the taillamp assembly by lining up the locator pins with the retainers in the vehicle's body.

11. Reinstall the two screws and tighten.
12. Close the liftgate.

## License Plate Lamp

To replace one of these bulbs, do the following:

1. Remove the two screws holding the license plate lamp lens.

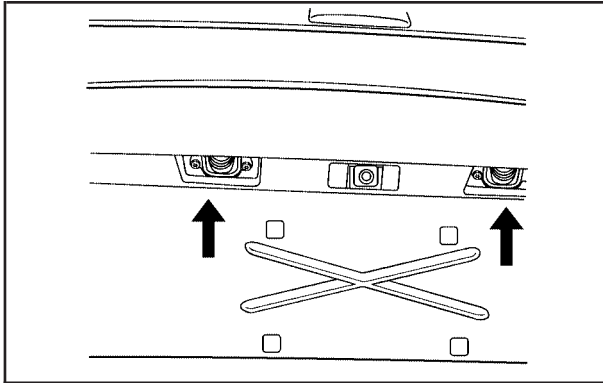

2. Pull the lens away from the lamp assembly.
3. Pull the old bulb straight out from the bulb socket.

4. Install the new bulb.
5. Replace the lamp assembly lens and tighten the screws.

## Replacement Bulbs

Exterior Lamp	Bulb Number
License Plate Lamp	W5W
Taillamps	3157

For replacement bulbs not listed here, contact your dealer.

# Windshield Wiper Blade Replacement

Windshield wiper blades should be inspected for wear or cracking. See *Scheduled Maintenance on page 517*.

Allowing the wiper blade arm to touch the windshield when no wiper blade is installed could damage the windshield. Any damage that occurs would not be covered by your warranty. Do not allow the wiper blade arm to touch the windshield.

1. To remove the old wiper blades, lift the wiper arm until it locks into a vertical position.

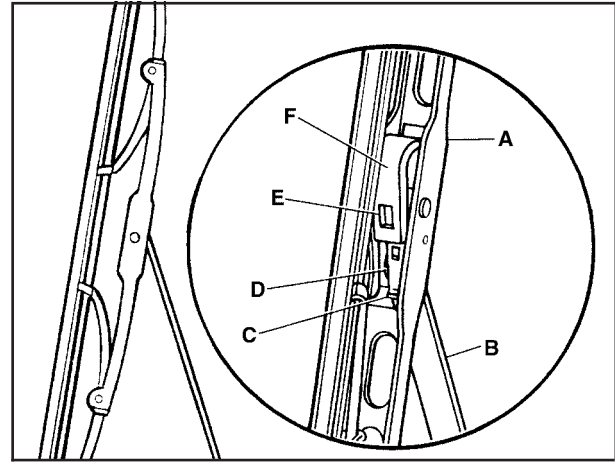

- |                   |                |
|-------------------|----------------|
| A. Blade Assembly | D. Blade Pivot |
| B. Arm Assembly   | E. Hook Slot   |
| C. Locking Tab    | F. Arm Hook    |

2. Press down on the blade assembly pivot locking tab. Pull down on the blade assembly to release it from the wiper arm hook.



3. Remove the insert from the blade assembly. The insert has two notches at one end that are locked by the bottom claws of the blade assembly. At the notched end, pull the insert from the blade assembly.

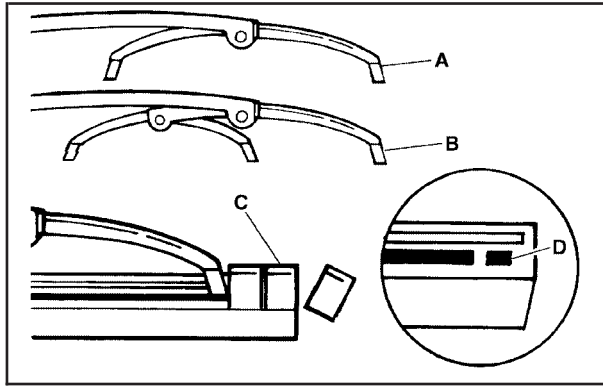

4. To install the new wiper insert, slide the insert (D), notched end last, into the end with two blade claws (A). Slide the insert all the way through the blade claws at the opposite end (B). The plastic caps (C) will be forced off as the insert is fully inserted.

5. Be sure that the notches are locked by the bottom claws. Make sure that all other claws are properly locked on both sides of the insert slots.

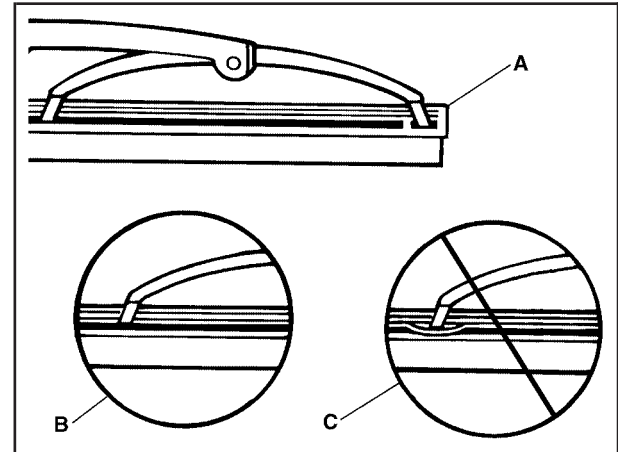

- A. Claw in Notch
- B. Correct Installation
- C. Incorrect Installation

6. Put the blade assembly pivot in the wiper arm hook. Pull up until the pivot locking tab locks in the hook slot.
7. Carefully lower the wiper arm and blade assembly onto the windshield.

## Backglass Wiper Blade Replacement

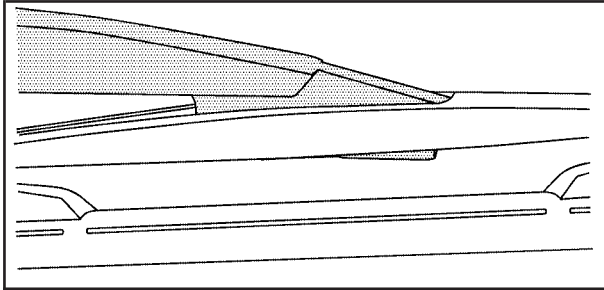

1. Lift the wiper blade assembly up and out of the park rest position.
2. Pull the wiper blade assembly away from the backglass. The backglass wiper blade will not lock in a vertical position, so care should be used when pulling it away from the vehicle.
3. Rotate the wiper blade assembly, and pull it off of the wiper arm. Hold the wiper arm in position and push the blade away from the wiper arm.

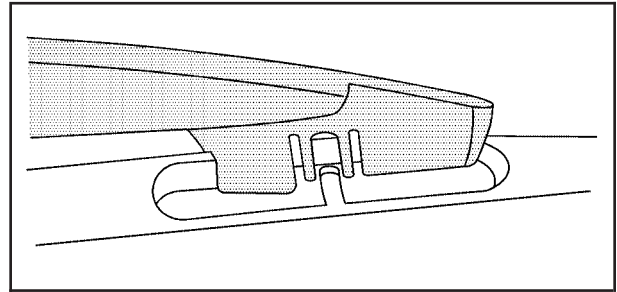

4. Replace the wiper blade.
5. Return the wiper blade assembly to the park rest position.

# Tires

Your new vehicle comes with high-quality tires made by a leading tire manufacturer. If you ever have questions about your tire warranty and where to obtain service, see your GM Warranty booklet for details. For additional information refer to the tire manufacturer's booklet included with your vehicle.

## CAUTION:

- Poorly maintained and improperly used tires are dangerous.
- Overloading your tires can cause overheating as a result of too much friction. You could have an air-out and a serious accident. See *Loading Your Vehicle on page 350*.

CAUTION: (Continued)

## CAUTION: (Continued)

- Underinflated tires pose the same danger as overloaded tires. The resulting accident could cause serious injury. Check all tires frequently to maintain the recommended pressure. Tire pressure should be checked when your tires are cold. See *Inflation - Tire Pressure on page 452*.
- Over inflated tires are more likely to be cut, punctured, or broken by a sudden impact — such as when you hit a pothole. Keep tires at the recommended pressure.
- Worn, old tires can cause accidents. If your tread is badly worn, or if your tires have been damaged, replace them.

See *High-Speed Operation on page 454* for inflation pressure adjustment for high speed driving.

## Low-Profile Performance Tire (Trailblazer SS)

If your vehicle has P255/50R20 size tires, they are classified as low-profile performance tires. These tires are designed for very responsive driving on wet or dry pavement. You may also notice more road noise with low-profile performance tires and that they tend to wear faster.

**Notice:** If your vehicle has low-profile tires, they are more susceptible to damage from road hazards or curb impact than standard profile tires. Tire and/or wheel assembly damage can occur when coming into contact with road hazards like, potholes, or sharp edged objects, or when sliding into a curb. Your GM warranty does not cover this type of damage. Keep tires set to the correct inflation pressure and, when possible avoid contact with curbs, potholes, and other road hazards.

## Winter Tires

For cold weather driving conditions you may prefer to get tires designed for snow or ice, if your vehicle has P255/50R20 size tires. See your dealer for details regarding winter tire availability and proper tire selection. Also, see *Buying New Tires* on page 462.

If you choose to use winter tires:

- Use tires of the same brand and tread type on all four wheel positions.
- Use only radial ply tires of the same size, load range, and speed rating as your original equipment tires.

Winter tires with the same speed rating as your original equipment tires may not be available for H, V, W, Y and ZR speed rated tires. If you choose winter tires with a lower speed rating, never exceed the tire's maximum speed capability.

## Tire Sidewall Labeling

Useful information about a tire is molded into the sidewall. The following illustrations are examples of a typical P-Metric and a LT-Metric tire sidewall.

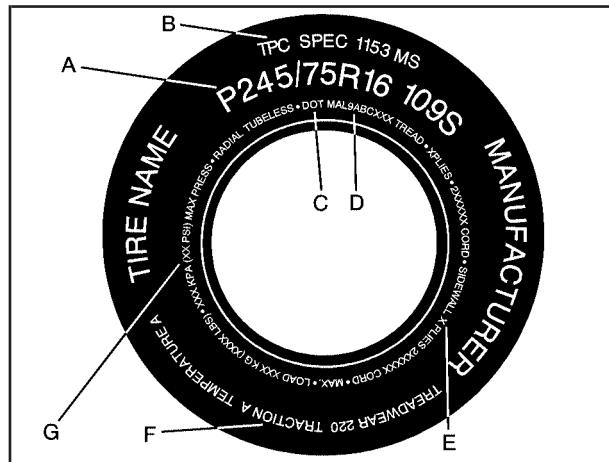

Passenger (P-Metric) Tire

**(A) Tire Size:** The tire size code is a combination of letters and numbers used to define a particular tire's width, height, aspect ratio, construction type, and service description. See the "Tire Size" illustration later in this section for more detail.

**(B) TPC Spec (Tire Performance Criteria Specification):** Original equipment tires designed to GM's specific tire performance criteria have a TPC specification code molded onto the sidewall. GM's TPC specifications meet or exceed all federal safety guidelines.

**(C) DOT (Department of Transportation):** The Department of Transportation (DOT) code indicates that the tire is in compliance with the U.S. Department of Transportation Motor Vehicle Safety Standards.

**(D) Tire Identification Number (TIN):** The letters and numbers following DOT code are the Tire Identification Number (TIN). The TIN shows the manufacturer and plant code, tire size, and date the tire was manufactured. The TIN is molded onto both sides of the tire, although only one side may have the date of manufacture.



**(B) TPC Spec (Tire Performance Criteria Specification):** Original equipment tires designed to GM's specific tire performance criteria have a TPC specification code molded onto the sidewall. GM's TPC specifications meet or exceed all federal safety guidelines.

**(C) Dual Tire Maximum Load:** Maximum load that can be carried and the maximum pressure needed to support that load when used in a dual configuration. For information on recommended tire pressure see *Inflation - Tire Pressure on page 452* and *Loading Your Vehicle on page 350*.

**(D) DOT (Department of Transportation):** The Department of Transportation (DOT) code indicates that the tire is in compliance with the U.S. Department of Transportation Motor Vehicle Safety Standards.

**(E) Tire Identification Number (TIN):** The letters and numbers following DOT code are the Tire Identification Number (TIN). The TIN shows the manufacturer and plant code, tire size, and date the tire was manufactured. The TIN is molded onto both sides of the tire, although only one side may have the date of manufacture.

**(F) Tire Ply Material:** The type of cord and number of plies in the sidewall and under the tread.

**(G) Single Tire Maximum Load:** Maximum load that can be carried and the maximum pressure needed to support that load when used as a single. For information on recommended tire pressure see *Inflation - Tire Pressure on page 452* and *Loading Your Vehicle on page 350*.

## Tire Size

The following examples show the different parts of a tire size.

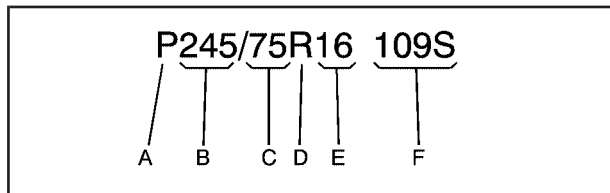

Passenger (P-Metric) Tire

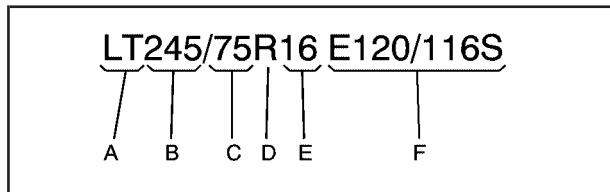

Light Truck (LT-Metric) Tire

**(A) Passenger (P-Metric) Tire:** The United States version of a metric tire sizing system. The letter P as the first character in the tire size means a passenger vehicle tire engineered to standards set by the U.S. Tire and Rim Association.

**(A) Light Truck (LT-Metric) Tire:** The United States version of a metric tire sizing system. The letters LT as the first two characters in the tire size means a light truck tire engineered to standards set by the U.S. Tire and Rim Association.

**(B) Tire Width:** The three-digit number indicates the tire section width in millimeters from sidewall to sidewall.

**(C) Aspect Ratio:** A two-digit number that indicates the tire height-to-width measurements. For example, if the tire size aspect ratio is 75, as shown in item C of the light truck (LT-Metric) tire illustration, it would mean that the tire's sidewall is 75 percent as high as it is wide.

**(D) Construction Code:** A letter code is used to indicate the type of ply construction in the tire. The letter R means radial ply construction; the letter D means diagonal or bias ply construction; and the letter B means belted-bias ply construction.



**(E) Rim Diameter:** Diameter of the wheel in inches.

**(F) Service Description:** The service description indicates the load range and speed rating of a tire. The load index can range from 1 to 279. Speed ratings range from A to Z.

## Tire Terminology and Definitions

**Air Pressure:** The amount of air inside the tire pressing outward on each square inch of the tire. Air pressure is expressed in pounds per square inch (psi) or kilopascal (kPa).

**Accessory Weight:** This means the combined weight of optional accessories. Some examples of optional accessories are, automatic transmission/transaxle, power steering, power brakes, power windows, power seats, and air conditioning.

**Aspect Ratio:** The relationship of a tire's height to its width.

**Belt:** A rubber coated layer of cords that is located between the plies and the tread. Cords may be made from steel or other reinforcing materials.

**Bead:** The tire bead contains steel wires wrapped by steel cords that hold the tire onto the rim.

**Bias Ply Tire:** A pneumatic tire in which the plies are laid at alternate angles less than 90 degrees to the centerline of the tread.

**Cold Tire Pressure:** The amount of air pressure in a tire, measured in pounds per square inch (psi) or kilopascals (kPa) before a tire has built up heat from driving. See *Inflation - Tire Pressure on page 452*.

**Curb Weight:** This means the weight of a motor vehicle with standard and optional equipment including the maximum capacity of fuel, oil, and coolant, but without passengers and cargo.

**DOT Markings:** A code molded into the sidewall of a tire signifying that the tire is in compliance with the U.S. Department of Transportation (DOT) motor vehicle safety standards. The DOT code includes the Tire Identification Number (TIN), an alphanumeric designator which can also identify the tire manufacturer, production plant, brand, and date of production.

**GVWR:** Gross Vehicle Weight Rating. See *Loading Your Vehicle on page 350*.

**GAWR FRT:** Gross Axle Weight Rating for the front axle. See *Loading Your Vehicle on page 350*.

**GAWR RR:** Gross Axle Weight Rating for the rear axle. See *Loading Your Vehicle on page 350*.

**Intended Outboard Sidewall:** The side of an asymmetrical tire, that must always face outward when mounted on a vehicle.

**Kilopascal (kPa):** The metric unit for air pressure.

**Light Truck (LT-Metric) Tire:** A tire used on light duty trucks and some multipurpose passenger vehicles.

**Load Index:** An assigned number ranging from 1 to 279 that corresponds to the load carrying capacity of a tire.

**Maximum Inflation Pressure:** The maximum air pressure to which a cold tire may be inflated. The maximum air pressure is molded onto the sidewall.

**Maximum Load Rating:** The load rating for a tire at the maximum permissible inflation pressure for that tire.

**Maximum Loaded Vehicle Weight:** The sum of curb weight, accessory weight, vehicle capacity weight, and production options weight.

**Normal Occupant Weight:** The number of occupants a vehicle is designed to seat multiplied by 150 lbs (68 kg). See *Loading Your Vehicle on page 350*.

**Occupant Distribution:** Designated seating positions.

**Outward Facing Sidewall:** The side of an asymmetrical tire that has a particular side that faces outward when mounted on a vehicle. The side of the tire that contains a whitewall, bears white lettering, or bears manufacturer, brand, and/or model name molding that is higher or deeper than the same moldings on the other sidewall of the tire.

**Passenger (P-Metric) Tire:** A tire used on passenger cars and some light duty trucks and multipurpose vehicles.

**Recommended Inflation Pressure:** Vehicle manufacturer's recommended tire inflation pressure as shown on the tire placard. See *Inflation - Tire Pressure on page 452* and *Loading Your Vehicle on page 350*.

**Radial Ply Tire:** A pneumatic tire in which the ply cords that extend to the beads are laid at 90 degrees to the centerline of the tread.

**Rim:** A metal support for a tire and upon which the tire beads are seated.

**Sidewall:** The portion of a tire between the tread and the bead.

**Speed Rating:** An alphanumeric code assigned to a tire indicating the maximum speed at which a tire can operate.

**Traction:** The friction between the tire and the road surface. The amount of grip provided.

**Tread:** The portion of a tire that comes into contact with the road.

**Treadwear Indicators:** Narrow bands, sometimes called wear bars, that show across the tread of a tire when only 1/16 inch (1.6 mm) of tread remains. See *When It Is Time for New Tires on page 462*.

**UTQGS (Uniform Tire Quality Grading Standards):** A tire information system that provides consumers with ratings for a tire's traction, temperature, and treadwear. Ratings are determined by tire manufacturers using government testing procedures. The ratings are molded into the sidewall of the tire. See *Uniform Tire Quality Grading* on page 465.

**Vehicle Capacity Weight:** The number of designated seating positions multiplied by 150 lbs (68 kg) plus the rated cargo load. See *Loading Your Vehicle* on page 350.

**Vehicle Maximum Load on the Tire:** Load on an individual tire due to curb weight, accessory weight, occupant weight, and cargo weight.

**Vehicle Placard:** A label permanently attached to a vehicle showing the vehicle's capacity weight and the original equipment tire size and recommended inflation pressure. See "Tire and Loading Information Label" under *Loading Your Vehicle* on page 350.

## Inflation - Tire Pressure

Tires need the correct amount of air pressure to operate effectively.

**Notice:** Do not let anyone tell you that under-inflation or over-inflation is all right. It is not. If your tires do not have enough air (under-inflation), you can get the following:

- Too much flexing
- Too much heat
- Tire overloading
- Premature or irregular wear
- Poor handling
- Reduced fuel economy

If your tires have too much air (over-inflation), you can get the following:

- Unusual wear
- Poor handling
- Rough ride
- Needless damage from road hazards

A Tire and Loading Information label is attached to the vehicle's center pillar (B-pillar), below the driver's door latch. This label shows your vehicle's original equipment tires and the correct inflation pressures for your tires when they are cold. The recommended cold tire inflation pressure, shown on the label, is the minimum amount of air pressure needed to support your vehicle's maximum load carrying capacity.

For additional information regarding how much weight your vehicle can carry, and an example of the tire and loading information label, see *Loading Your Vehicle on page 350*. How you load your vehicle affects vehicle handling and ride comfort, never load your vehicle with more weight than it was designed to carry.

## When to Check

Check your tires once a month or more.

Also, check the tire pressure of the spare tire.

## How to Check

Use a good quality pocket-type gage to check tire pressure. You cannot tell if your tires are properly inflated simply by looking at them. Radial tires may look properly inflated even when they're underinflated. Check the tire's inflation pressure when the tires are cold. Cold means your vehicle has been sitting for at least three hours or driven no more than 1 mile (1.6 km).

Remove the valve cap from the tire valve stem. Press the tire gage firmly onto the valve to get a pressure measurement. If the cold tire inflation pressure matches the recommended pressure on the tire and loading information label, no further adjustment is necessary. If the pressure is low, add air until you reach the recommended amount.

If you overfill the tire, release air by pushing on the metal stem in the center of the tire valve. Recheck the tire pressure with the tire gage.

Be sure to put the valve caps back on the valve stems. They help prevent leaks by keeping out dirt and moisture.

## High-Speed Operation

### CAUTION:

**Driving at high speeds, 100 mph (160 km/h) or higher, puts an additional strain on tires. Sustained high-speed driving causes excessive heat build up and can cause sudden tire failure. You could have a crash and you or others could be killed. Some high-speed rated tires require inflation pressure adjustment for high speed operation. When speed limits and road conditions are such that a vehicle can be driven at high speeds, make sure the tires are rated for high speed operation, in excellent condition, and set to the correct cold tire inflation pressure for the vehicle load.**

If your vehicle has P255/50R20 104V size tires installed on the rear axle, they will require inflation pressure adjustment when driving your vehicle at speeds above 99 mph (160 km/h). Set the cold inflation pressure, for the rear tires only, to the maximum inflation pressure shown on the tire sidewall, or 38 psi (262 kPa), whichever is lower. See the example following. When you end this high-speed driving, return the tires to the cold tire inflation pressure shown on the Tire and Loading Information label. See *Loading Your Vehicle* on page 350.

Example:

You will find the maximum load and inflation pressure molded on the tire's sidewall, in small letters, near the rim flange. It will read something like this: Maximum load 690 kg (1521 lbs) 300 kPa (44 psi) Max. Press.

For this example, you would set the inflation pressure for high-speed driving at 38 psi (262 kPa).

The inflation pressure for the front tires should be set to the cold tire inflation pressure shown on the Tire and Loading Information label.

Racing or other competitive driving may affect the warranty coverage of your vehicle. See your warranty booklet for more information.

## Tire Pressure Monitor System

The Tire Pressure Monitor System (TPMS) uses radio and sensor technology to check tire pressure levels. TPMS sensors are mounted on each tire and wheel assembly, except the spare tire. The TPMS sensors monitor the air pressure in your vehicle's tires and transmit tire pressure readings to a receiver located in the vehicle.

The TPMS is designed to alert the driver if a low tire pressure condition exists. If your vehicle has the Driver Information Center (DIC) steering wheel control buttons, tire pressure levels may also be checked through the DIC. See "Tire Pressures" under *DIC Operation and Displays on page 217*.

When a low tire pressure condition is detected, the TPMS will illuminate the low tire pressure warning symbol located on the instrument panel cluster, and at the same time a message will also appear on the DIC display. The low tire pressure warning symbol on the instrument panel cluster and the CHECK TIRE PRESSURE warning message on the DIC will appear at each ignition cycle until the tires are inflated to the correct inflation pressure.

For additional information and details about the DIC operation and displays see *DIC Operation and Displays* on page 217 and *DIC Warnings and Messages* on page 220.

You may notice, during cooler weather conditions, that the tire pressure monitor light, located on the instrument panel cluster, and the CHECK TIRE PRESSURE message will appear when the vehicle is first started, and then turn off as you start to drive the vehicle. This could be an early indicator that the tire pressures are getting low and need to be inflated to the proper pressure.

Each tire, including the spare (if provided), should be checked monthly when cold and inflated to the inflation pressure recommended by the vehicle manufacturer on the vehicle placard or tire inflation pressure label. (If your vehicle has tires of a different size than the size indicated on the vehicle placard or tire inflation pressure label, you should determine the proper tire inflation pressure for those tires.)

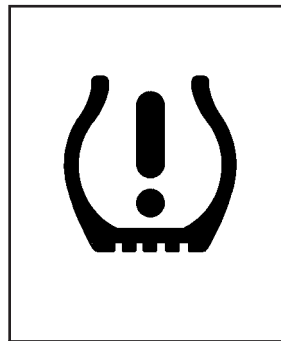

As an added safety feature, your vehicle has been equipped with a tire pressure monitoring system (TPMS) that illuminates a low tire pressure telltale when one or more of your tires is significantly under-inflated.

Accordingly, when the low tire pressure telltale illuminates, you should stop and check your tires as soon as possible, and inflate them to the proper pressure. Driving on a significantly under-inflated tire causes the tire to overheat and can lead to tire failure. Under-inflation also reduces fuel efficiency and tire tread life, and may affect the vehicle's handling and stopping ability.

Please note that the TPMS is not a substitute for proper tire maintenance, and it is the driver's responsibility to maintain correct tire pressure, even if under-inflation has not reached the level to trigger illumination of the TPMS low tire pressure telltale.



Your vehicle has also been equipped with a TPMS malfunction indicator to indicate when the system is not operating properly. The TPMS malfunction indicator is combined with the low tire pressure telltale. When the system detects a malfunction, the telltale will flash for approximately one minute and then remain continuously illuminated. This sequence will continue upon subsequent vehicle start-ups as long as the malfunction exists.

When the malfunction indicator is illuminated, the system may not be able to detect or signal low tire pressure as intended. TPMS malfunctions may occur for a variety of reasons, including the installation of replacement or alternate tires or wheels on the vehicle that prevent the TPMS from functioning properly. Always check the TPMS malfunction telltale after replacing one or more tires or wheels on your vehicle to ensure that the replacement or alternate tires and wheels allow the TPMS to continue to function properly.

The Tire and Loading Information label (tire information placard) shows the size of your vehicle's original tires and the correct inflation pressure for your vehicle's tires when they are cold. See *Inflation - Tire Pressure* on page 452. For the location of the tire and loading information label, see *Loading Your Vehicle* on page 350.

Your vehicle's TPMS can alert you about a low tire pressure condition but it does not replace normal tire maintenance. See *Tire Inspection and Rotation* on page 460 and *Tires* on page 443.

**Notice:** Do not use a tire sealant if your vehicle has Tire Pressure Monitors. The liquid sealant can damage the tire pressure monitor sensors.

## TPMS Sensor Identification Codes

Each TPMS sensor has a unique identification code. Any time you replace one or more of the TPMS sensors or rotate the vehicle's tires, the identification codes will need to be matched to the new tire/wheel position. The sensors are matched to the tire/wheel positions in the following order: driver's side front tire, passenger's side front tire, passenger's side rear tire, and driver's side rear tire using a TPMS diagnostic tool. See your dealer for service.

The TPMS sensors may also be matched to each tire/wheel position by increasing or decreasing the tire's air pressure. When increasing the tire's pressure, do not exceed the maximum inflation pressure indicated on the tire's sidewall.

You will have two minutes to match the first tire/wheel position, and five minutes overall to match all four tire/wheel positions. If it takes longer than two minutes, to match the first tire and wheel, or more than five minutes to match all four tire and wheel positions the matching process stops and you will need to start over.

The TPMS sensor matching process is outlined below:

1. Set the parking brake.
2. Turn the ignition switch to RUN with the engine off.
3. Turn the headlamp control from off to parking lamps four times within three seconds. A double horn chirp will sound and the TPMS low tire warning light will begin to flash. The double horn chirp and flashing TPMS warning light indicate that the TPMS matching process has started. The TPMS warning light should continue flashing throughout the matching procedure.
4. Start with the driver's side front tire.

5. Remove the valve cap from the valve cap stem. Activate the TPMS sensor by increasing or decreasing the tire's air pressure for 10 seconds, then stop and listen for a single horn chirp. The single horn chirp should sound within 15 seconds, confirming that the sensor identification code has been matched to this tire and wheel position. If you do not hear the confirming single horn chirp, you will need to start over with step number one. To let air-pressure out of a tire you can use the pointed end of the valve cap, a pencil-style air pressure gage, or a key.
6. Proceed to the passenger's side front tire, and repeat the procedure in Step 5.
7. Proceed to the passenger's side rear tire, and repeat the procedure in Step 5.
8. Proceed to the driver's side rear tire, and repeat the procedure in Step 5.
9. After hearing the confirming horn chirp for the driver's side rear tire, check to see if the TPMS warning light is still flashing. If yes, turn the ignition switch to LOCK to exit the sensor matching process. If the TPMS warning light is not flashing, the five minute time limit has passed and you will need to start the process over beginning with Step 1.
10. Set all four tires to the recommended air pressure level as indicated on the Tire and Loading Information label.
11. Put the valve caps back on the valve stems

The spare tire does not have a TPMS sensor. If you replace one of the road tires with the spare, the SERVICE TIRE MONITOR message will be displayed on the DIC screen. This message should go off once you re-install the road tire containing the TPMS sensor.

## Federal Communications Commission (FCC) and Industry and Science Canada

The Tire Pressure Monitor System (TPMS) operates on a radio frequency and complies with Part 15 of the FCC Rules. Operation is subject to the following two conditions:

1. This device may not cause harmful interference.
2. This device must accept any interference received, including interference that may cause undesired operation.

The Tire Pressure Monitor System (TPMS) operates on a radio frequency and complies with RSS-210 of Industry and Science Canada. Operation is subject to the following two conditions:

1. This device may not cause interference.
2. This device must accept any interference received, including interference that may cause undesired operation of the device.

Changes or modifications to this system by other than an authorized service facility could void authorization to use this equipment.

## Tire Inspection and Rotation

Tires should be rotated every 5,000 to 8,000 miles (8 000 to 13 000 km).

Any time you notice unusual wear, rotate your tires as soon as possible and check wheel alignment. Also check for damaged tires or wheels. See *When It Is Time for New Tires on page 462* and *Wheel Replacement on page 467* for more information.

Make sure the spare tire is stored securely. Push, pull, and then try to rotate or turn the tire. If it moves, use the wheel wrench to tighten the cable. For information on storing or removing the spare tire, see *Changing a Flat Tire on page 472*.

The purpose of regular rotation is to achieve more uniform wear for all tires on the vehicle. The first rotation is the most important. See *Scheduled Maintenance on page 517*.

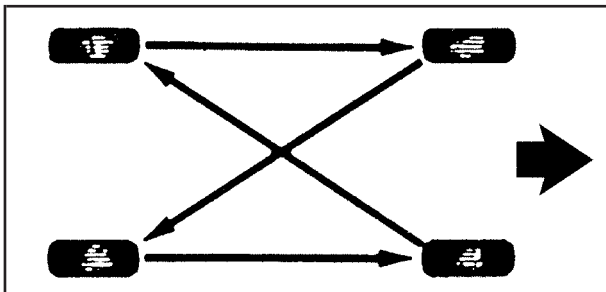

When rotating your tires, always use the correct rotation pattern shown here.

After the tires have been rotated, adjust the front and rear inflation pressures as shown on the Tire and Loading Information label. See *Loading Your Vehicle on page 350*, for an example of the label and its location on your vehicle.

The Tire Pressure Monitor System (TPMS) sensors will need to be reset after a tire rotation. See “TPMS Sensor Identification Codes” under *Tire Pressure Monitor System on page 455*.

Make certain that all wheel nuts are properly tightened. See “Wheel Nut Torque” under *Capacities and Specifications on page 510*.

**⚠ CAUTION:**

**Rust or dirt on a wheel, or on the parts to which it is fastened, can make wheel nuts become loose after time. The wheel could come off and cause an accident. When you change a wheel, remove any rust or dirt from places where the wheel attaches to the vehicle. In an emergency, you can use a cloth or a paper towel to do this; but be sure to use a scraper or wire brush later, if needed, to get all the rust or dirt off. See *Changing a Flat Tire on page 472*.**

## When It Is Time for New Tires

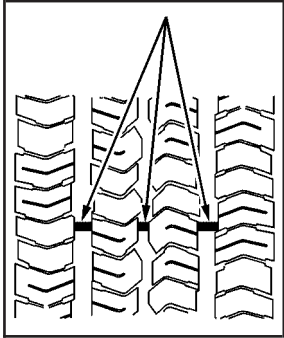

One way to tell when it is time for new tires is to check the treadwear indicators, which will appear when your tires have only 1/16 inch (1.6 mm) or less of tread remaining. Some commercial truck tires may not have treadwear indicators.

You need a new tire if any of the following statements are true:

- You can see the indicators at three or more places around the tire.
- You can see cord or fabric showing through the tire's rubber.
- The tread or sidewall is cracked, cut or snagged deep enough to show cord or fabric.
- The tire has a bump, bulge, or split.
- The tire has a puncture, cut, or other damage that cannot be repaired well because of the size or location of the damage.

## Buying New Tires

GM has developed and matched specific tires for your vehicle. The original equipment tires installed on your vehicle, when it was new, were designed to meet General Motors Tire Performance Criteria Specification (TPC spec) system rating. If you need replacement tires, GM strongly recommends that you get tires with the same TPC Spec rating. This way, your vehicle will continue to have tires that are designed to give the same performance and vehicle safety, during normal use, as the original tires.

GM's exclusive TPC Spec system considers over a dozen critical specifications that impact the overall performance of your vehicle, including brake system performance, ride and handling, traction control, and tire pressure monitoring performance. GM's TPC Spec number is molded onto the tire's sidewall by the tire manufacturer. If the tires have an all-season tread design, the TPC spec number will be followed by a MS, for mud and snow. See *Tire Sidewall Labeling on page 445* for additional information.

 **CAUTION:**

**Mixing tires could cause you to lose control while driving. If you mix tires of different sizes, brands, or types (radial and bias-belted tires) the vehicle may not handle properly, and you could have a crash. Using tires of different sizes, brands, or types may also cause damage to your vehicle. Be sure to use the correct size, brand, and type of tires on your vehicle's wheels.**

 **CAUTION:**

**If you use bias-ply tires on your vehicle, the wheel rim flanges could develop cracks after many miles of driving. A tire and/or wheel could fail suddenly, causing a crash. Use only radial-ply tires with the wheels on your vehicle.**

If you must replace your vehicle's tires with those that do not have a TPC Spec number, make sure they are the same size, load range, speed rating, and construction type (radial and bias-belted tires) as your vehicle's original tires.

Vehicles equipped with a tire pressure monitoring system may give an inaccurate low-pressure warning if non-TPC spec rated tires are installed on your vehicle. Non-TPC Spec rated tires may give a low-pressure warning that is higher or lower than the proper warning level you would get with TPC Spec rated tires. See *Tire Pressure Monitor System* on page 455.

Your vehicle's original equipment tires are listed on the Tire and Loading Information Label. This label is attached to the vehicle's center pillar (B-pillar). See *Loading Your Vehicle on page 350*, for more information about the Tire and Loading Information Label.

## Different Size Tires and Wheels

If you add wheels or tires that are a different size than your original equipment wheels and tires, this may affect the way your vehicle performs, including its braking, ride and handling characteristics, stability, and resistance to rollover. Additionally, if your vehicle has electronic systems such as, anti-lock brakes, traction control, and electronic stability control, the performance of these systems can be affected.

### CAUTION:

**If you add different sized wheels, your vehicle may not provide an acceptable level of performance and safety if tires not recommended for those wheels are selected. You may increase the chance that you will crash and suffer serious injury. Only use GM specific wheel and tire systems developed for your vehicle, and have them properly installed by a GM certified technician.**

See *Buying New Tires on page 462* and *Accessories and Modifications on page 382* for additional information.



## Uniform Tire Quality Grading

Quality grades can be found where applicable on the tire sidewall between tread shoulder and maximum section width. For example:

### **Treadwear 200 Traction AA Temperature A**

The following information relates to the system developed by the United States National Highway Traffic Safety Administration (NHTSA), which grades tires by treadwear, traction, and temperature performance. This applies only to vehicles sold in the United States. The grades are molded on the sidewalls of most passenger car tires. The Uniform Tire Quality Grading (UTQG) system does not apply to deep tread, winter-type snow tires, space-saver, or temporary use spare tires, tires with nominal rim diameters of 10 to 12 inches (25 to 30 cm), or to some limited-production tires.

While the tires available on General Motors passenger cars and light trucks may vary with respect to these grades, they must also conform to federal safety requirements and additional General Motors Tire Performance Criteria (TPC) standards.

## Treadwear

The treadwear grade is a comparative rating based on the wear rate of the tire when tested under controlled conditions on a specified government test course. For example, a tire graded 150 would wear one and a half (1.5) times as well on the government course as a tire graded 100. The relative performance of tires depends upon the actual conditions of their use, however, and may depart significantly from the norm due to variations in driving habits, service practices, and differences in road characteristics and climate.

### **Traction – AA, A, B, C**

The traction grades, from highest to lowest, are AA, A, B, and C. Those grades represent the tire's ability to stop on wet pavement as measured under controlled conditions on specified government test surfaces of asphalt and concrete. A tire marked C may have poor traction performance.

**Warning:** The traction grade assigned to this tire is based on straight-ahead braking traction tests, and does not include acceleration, cornering, hydroplaning, or peak traction characteristics.

## Temperature – A, B, C

The temperature grades are A (the highest), B, and C, representing the tire's resistance to the generation of heat and its ability to dissipate heat when tested under controlled conditions on a specified indoor laboratory test wheel. Sustained high temperature can cause the material of the tire to degenerate and reduce tire life, and excessive temperature can lead to sudden tire failure. The grade C corresponds to a level of performance which all passenger car tires must meet under the Federal Motor Vehicle Safety Standard No. 109. Grades B and A represent higher levels of performance on the laboratory test wheel than the minimum required by law.

**Warning:** The temperature grade for this tire is established for a tire that is properly inflated and not overloaded. Excessive speed, underinflation, or excessive loading, either separately or in combination, can cause heat buildup and possible tire failure.

## Wheel Alignment and Tire Balance

The tires and wheels on your vehicle were aligned and balanced carefully at the factory to give you the longest tire life and best overall performance. Adjustments to wheel alignment and tire balancing will not be necessary on a regular basis. However, if you notice unusual tire wear or your vehicle pulling to one side or the other, the alignment may need to be checked. If you notice your vehicle vibrating when driving on a smooth road, your tires and wheels may need to be rebalanced. See your dealer for proper diagnosis.

## Wheel Replacement

Replace any wheel that is bent, cracked, or badly rusted or corroded. If wheel nuts keep coming loose, the wheel, wheel bolts, and wheel nuts should be replaced. If the wheel leaks air, replace it (except some aluminum wheels, which can sometimes be repaired). See your dealer if any of these conditions exist.

Your dealer will know the kind of wheel you need.

Each new wheel should have the same load-carrying capacity, diameter, width, offset and be mounted the same way as the one it replaces.

If you need to replace any of your wheels, wheel bolts, or wheel nuts, replace them only with new GM original equipment parts. This way, you will be sure to have the right wheel, wheel bolts, and wheel nuts for your vehicle.

### CAUTION:

**Using the wrong replacement wheels, wheel bolts, or wheel nuts on your vehicle can be dangerous. It could affect the braking and handling of your vehicle, make your tires lose air and make you lose control. You could have a collision in which you or others could be injured. Always use the correct wheel, wheel bolts, and wheel nuts for replacement.**

***Notice:*** The wrong wheel can also cause problems with bearing life, brake cooling, speedometer or odometer calibration, headlamp aim, bumper height, vehicle ground clearance, and tire or tire chain clearance to the body and chassis.

See *Changing a Flat Tire on page 472* for more information.

## Used Replacement Wheels

### CAUTION:

Putting a used wheel on your vehicle is dangerous. You cannot know how it has been used or how far it has been driven. It could fail suddenly and cause a crash. If you have to replace a wheel, use a new GM original equipment wheel.

## Tire Chains

### CAUTION:

Do not use tire chains. There is not enough clearance. Tire chains used on a vehicle without the proper amount of clearance can cause damage to the brakes, suspension, or other vehicle parts. The area damaged by the tire chains could cause you to lose control of your vehicle and you or others may be injured in a crash. Use another type of traction device only if its manufacturer recommends it for use on your vehicle and tire size combination and road conditions. Follow that manufacturer's instructions. To help avoid damage to your vehicle, drive slowly, re-adjust or remove the device if it is contacting your vehicle, and do not spin your wheels. If you do find traction devices that will fit, install them on the rear tires.

## Accessory Inflator

Your vehicle may have an accessory inflator system. You can inflate things like basketballs and bicycle tires. You can also use it to bring your tire pressure up to the proper pressure. It is not designed to inflate large objects which will require more than five minutes to inflate, such as an air mattress.

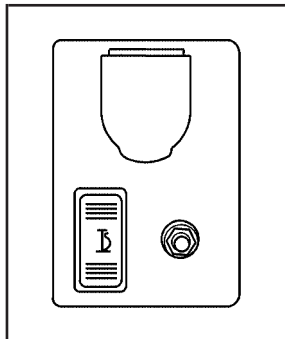

The accessory inflator is located in the rear compartment on the driver's side of the vehicle behind an access cover, near the liftgate opening.

To remove the cover, push in on the tab to access the inflator.

You may have an air inflator kit that is located in the glove compartment. It includes a 22 ft (6.7 m) hose with three nozzle adapters.

To use the accessory inflator, do the following:

1. Attach the appropriate nozzle adapter to the end of the hose, if required.

### CAUTION:

**Inflating something too much can make it explode, and you or others could be injured. Be sure to read the inflator instructions, and inflate any object only to its recommended pressure.**

2. Attach that end of the hose to the object you wish to inflate.
3. Attach the other end of the hose to the outlet.

4. Press and release the switch to turn the air inflator on. The indicator light will remain on when the inflator is running.

The system has an internal clock to prevent the system from overheating. The system will allow about five minutes of running time, then the compressor will stop. The indicator light will then begin to flash. When the indicator is off, the inflator can be started again by pressing the switch. If the compressor is still hot, it may only run for a short time before shutting off again.

5. Press and release the switch to turn the inflator off.

Place the inflator kit tools in the pouch and store it in its proper location. Remove the inflator hose from the outlet during loading and unloading. Load leveling will not function with the inflator hose attached to the inflator outlet. See *Electronically Controlled Air Suspension System on page 361* for more information.

To reinstall the cover, line up the tabs at the back of the cover, put it in place and latch the tabs.

A continuous flashing indicator light may also indicate a malfunction in the air suspension system. See *Electronically Controlled Air Suspension System on page 361* for more information.

## If a Tire Goes Flat

It is unusual for a tire to blowout while you are driving, especially if you maintain your vehicle's tires properly. If air goes out of a tire, it is much more likely to leak out slowly. But if you should ever have a blowout, here are a few tips about what to expect and what to do:

If a front tire fails, the flat tire will create a drag that pulls the vehicle toward that side. Take your foot off the accelerator pedal and grip the steering wheel firmly. Steer to maintain lane position, and then gently brake to a stop well out of the traffic lane.

A rear blowout, particularly on a curve, acts much like a skid and may require the same correction you would use in a skid. In any rear blowout remove your foot from the accelerator pedal. Get the vehicle under control by steering the way you want the vehicle to go. It may be very bumpy and noisy, but you can still steer. Gently brake to a stop, well off the road if possible.

### CAUTION:

**Lifting a vehicle and getting under it to do maintenance or repairs is dangerous without the appropriate safety equipment and training. The jack provided with your vehicle is designed only for changing a flat tire. If it is used for anything else, you or others could be badly injured or killed if the vehicle slips off the jack. Use the jack provided with your vehicle only for changing a flat tire.**

If a tire goes flat, the next part shows how to use the jacking equipment to change a flat tire safely.

## Changing a Flat Tire

If a tire goes flat, avoid further tire and wheel damage by driving slowly to a level place. Turn on your hazard warning flashers. See *Hazard Warning Flashers* on page 170 for more information.

### CAUTION:

Changing a tire can be dangerous. The vehicle can slip off the jack and roll over or fall on you or other people. You and they could be badly injured or even killed. Find a level place to change your tire. To help prevent the vehicle from moving:

1. Set the parking brake firmly.
2. Put the shift lever in PARK (P).

**CAUTION: (Continued)**

### **CAUTION: (Continued)**

3. If you have a four-wheel-drive vehicle, be sure the transfer case is in a drive gear — not in NEUTRAL.
4. Turn off the engine and do not restart while the vehicle is raised.
5. Do not allow passengers to remain in the vehicle.
6. Put the wheel blocks at the front and rear of the tire farthest away from the one being changed. That would be the tire on the other side, at the opposite end of the vehicle.



When your vehicle has a flat tire, use the following example as a guide to assist you in the placement of wheel blocks.

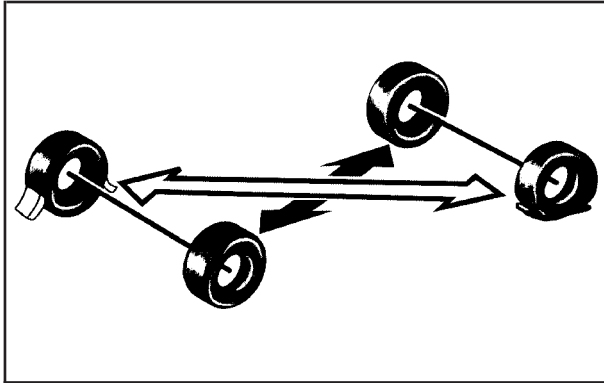

The following information will tell you how to use the jack and change a tire.

## Removing the Spare Tire and Tools

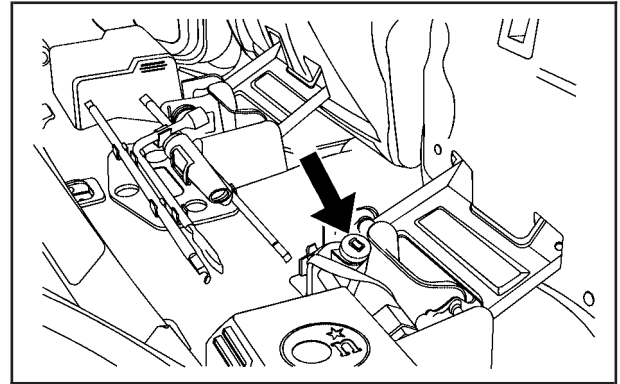

The jacking equipment needed to remove the spare tire is stored under the rear seat. To release the jack from its holder, turn the knob on the jack counterclockwise to lower the jack head. See *Rear Seat Operation* on page 18 for more information.

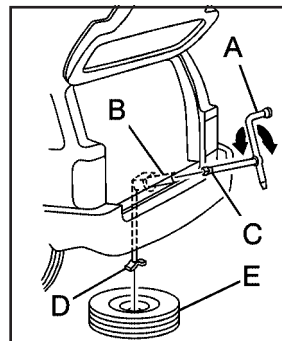
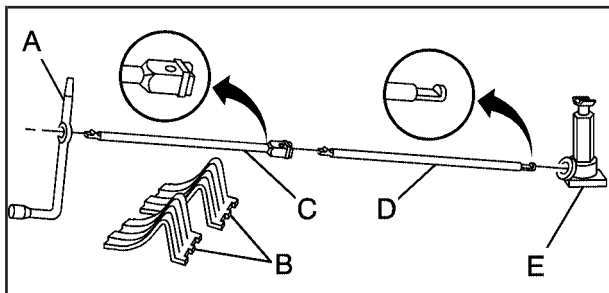

- A. Wheel Wrench
- B. Hoist Shaft
- C. Extension
- D. Retainer
- E. Spare or Flat Tire (Valve Stem Pointed Up)

The tools you will be using include the wheel wrench (A), wheel blocks (B), extension(s) (socket end) (C), handle (jack end) (D), and jack (E).

The following instructions explain how to remove the underbody-mounted spare underneath your vehicle.

**Notice:** If you remove or restow a tire from/to the storage position under the vehicle when it is supported by a jack, you could damage the tire and/or your vehicle. Always remove or restow a tire when the vehicle is on the ground.

1. Open the liftgate. See *Liftgate/Liftglass* on page 106 for more information.
2. Attach the wheel wrench (A) to the extension (C).

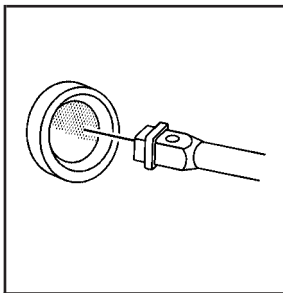

3. Insert the socket end of the extension (C) on a 45 degree angle downward into the hoist drive shaft hole.

It is exposed when the rear gate is open and is just above the rear bumper. Be sure the socket end of the extension (C) connects to the hoist shaft.

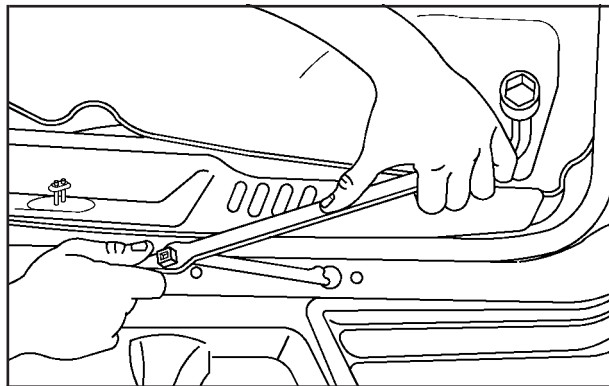

4. Turn the wheel wrench counterclockwise to lower the spare tire. Keep turning the wheel wrench until the spare tire can be pulled out from under the vehicle.

If the spare tire does not lower to the ground, the secondary latch is engaged causing the tire not to lower. See *Secondary Latch System on page 482* for more information.

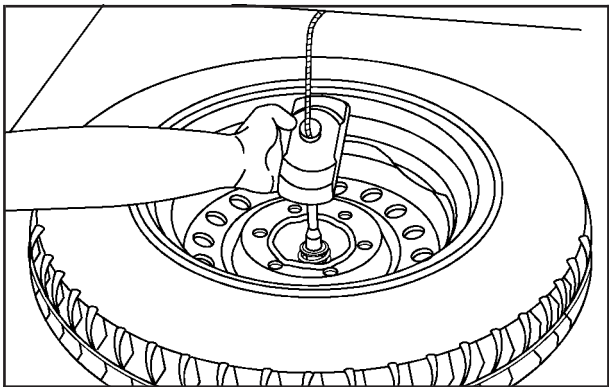

5. Tilt the retainer at the end of the cable when the tire has been completely lowered, and pull it through the wheel opening.

6. Pull the tire out from under the vehicle.

**Notice:** If you drive away before the spare tire or secondary latch system cable has been reinstalled, you could damage your vehicle. Always reinstall this cable before driving your vehicle.

7. Put the spare tire near the flat tire.

## Removing the Flat Tire and Installing the Spare Tire

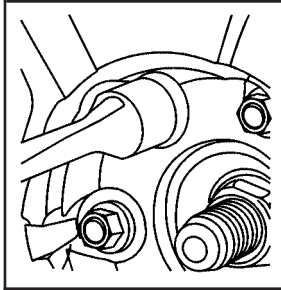

1. Using the wheel wrench, loosen all the wheel nuts. Do not remove them yet.

2. Turn the jack adjusting knob clockwise by hand to raise the jack lift head.
3. Place the handle, extension and wheel wrench onto the jack.

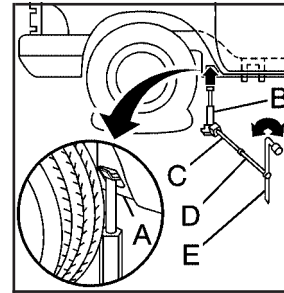

Front Position

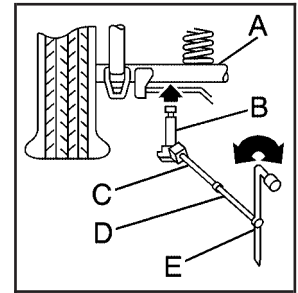

Rear Position

- A. Front Frame/Rear Axle
  - B. Handle
  - C. Extension
  - D. Extension
  - E. Wheel Wrench
4. Place the jack in the appropriate position nearest the flat tire.

**⚠ CAUTION:**

Getting under a vehicle when it is jacked up is dangerous. If the vehicle slips off the jack you could be badly injured or killed. Never get under a vehicle when it is supported only by a jack.

**⚠ CAUTION:**

Raising your vehicle with the jack improperly positioned can damage the vehicle and even make the vehicle fall. To help avoid personal injury and vehicle damage, be sure to fit the jack lift head into the proper location before raising the vehicle.

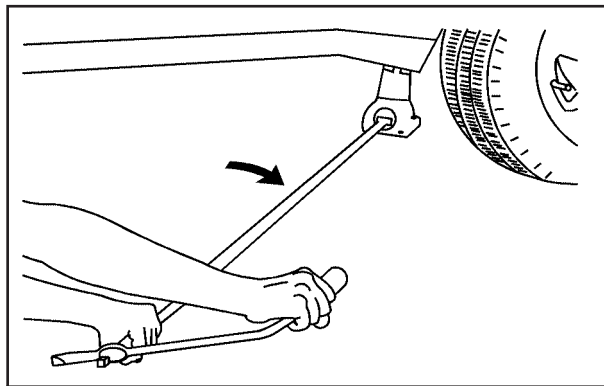

5. Raise the vehicle by turning the jack handle clockwise. Raise the vehicle far enough off the ground so there is enough room for the spare tire to fit.

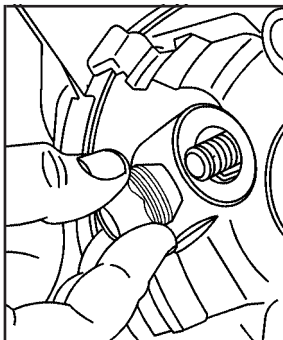

6. Remove all the wheel nuts and take off the flat tire.

**⚠ CAUTION:**

Rust or dirt on the wheel, or on the parts to which it is fastened, can make the wheel nuts become loose after time. The wheel could come off and cause an accident. When you change a wheel, remove any rust or dirt from the places where the wheel attaches to the vehicle.

**CAUTION: (Continued)**

**CAUTION: (Continued)**

In an emergency, you can use a cloth or a paper towel to do this; but be sure to use a scraper or wire brush later, if needed, to get all the rust or dirt off.

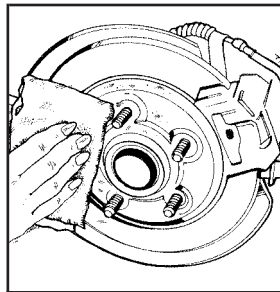

7. Remove any rust or dirt from the wheel bolts, mounting surfaces and spare wheel.

8. Place the spare tire on the wheel-mounting surface.

**⚠ CAUTION:**

**Never use oil or grease on studs or nuts. If you do, the nuts might come loose. Your wheel could fall off, causing a serious accident.**

9. Put the nuts on by hand. Make sure the rounded end is toward the wheel.
10. Tighten each nut by hand until the wheel is held against the hub. If a nut cannot be turned by hand, use the wheel wrench and see your dealer as soon as possible.

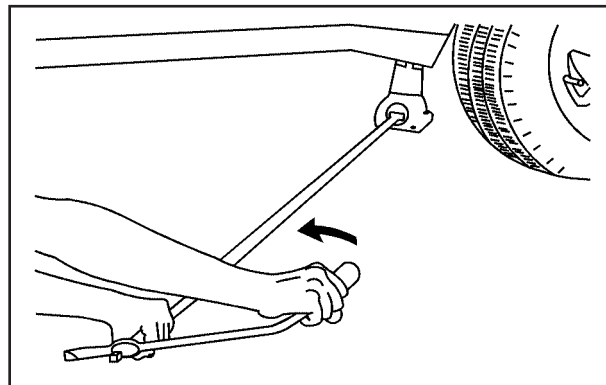

11. Lower the vehicle by turning the jack handle counterclockwise. Lower the jack completely.



**⚠ CAUTION:**

Incorrect wheel nuts or improperly tightened wheel nuts can cause the wheel to come loose and even come off. This could lead to an accident. Be sure to use the correct wheel nuts. If you have to replace them, be sure to get new original equipment wheel nuts. Stop somewhere as soon as you can and have the nuts tightened with a torque wrench to the proper torque specification. See *Capacities and Specifications on page 510* for wheel nut torque specification.

**Notice:** Improperly tightened wheel nuts can lead to brake pulsation and rotor damage. To avoid expensive brake repairs, evenly tighten the wheel nuts in the proper sequence and to the proper torque specification. See *Capacities and Specifications on page 510* for the wheel nut torque specification.

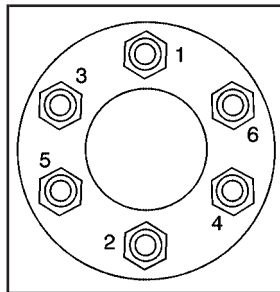

12. Use the wrench to tighten the wheel nuts firmly in a crisscross sequence as shown.

## Secondary Latch System

Your vehicle has an underbody-mounted tire hoist assembly equipped with a secondary latch system. It is designed to stop the spare tire from suddenly falling off your vehicle if the cable holding the spare tire is damaged. For the secondary latch to work, the tire must be stored with the valve stem pointing up. See *Storing a Flat or Spare Tire and Tools on page 486* for instructions on storing the spare or flat tire correctly.

### CAUTION:

**Before beginning this procedure read all the instructions. Failure to read and follow the instructions could damage the hoist assembly and you and others could get hurt. Read and follow the instructions listed next.**

### CAUTION:

**Someone standing too close during the procedure could be injured by the jack. If the spare tire does not slide off the jack completely, make sure no one is behind you or on either side of you as you pull the jack out from the spare.**

To release the spare tire from the secondary latch, do the following:

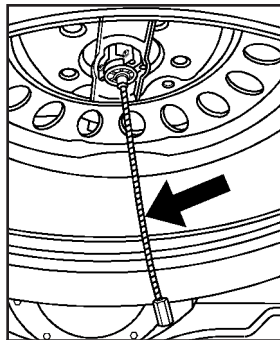

1. Check under the vehicle to see if the cable is visible. If it is not visible, proceed to Step 6.

2. If visible, first try to tighten the cable by turning the wheel wrench clockwise until you hear two clicks or feel it skip twice. You cannot overtighten the cable.
3. Loosen the cable by turning the wheel wrench counterclockwise three or four turns.
4. Repeat this procedure at least two times.  
If the spare tire lowers to the ground, continue with Step 2 of *Removing the Spare Tire and Tools on page 473*.
5. Turn the wrench counterclockwise until approximately 6 inches (15 cm) of cable is exposed.

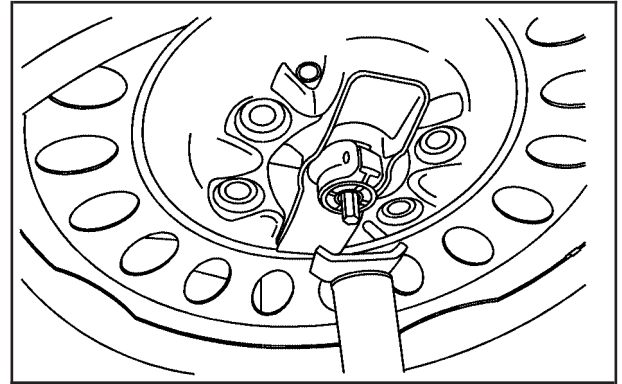

6. Attach the jack handle, extension(s) and the wheel wrench to the jack and place it under the vehicle towards the front of the rear bumper. Position the center lift point of the jack under the center of the spare tire.
7. Turn the wrench clockwise to raise the jack until it lifts the end fitting.

8. Continue raising the jack until the spare tire stops moving upward and is held firmly in place. The secondary latch has released and the spare tire is balancing on the jack.
9. Lower the jack by turning the wheel wrench counterclockwise. Keep lowering the jack until the spare tire slides off the jack or is hanging by the cable.
10. Disconnect the jack handle from the jack and carefully remove the jack. Use one hand to push against the spare while firmly pulling the jack out from under the spare tire with the other hand.

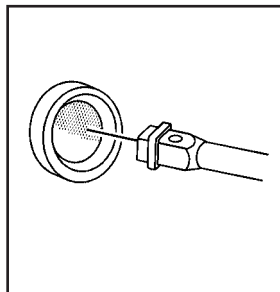

11. If the spare tire is hanging from the cable, insert the socket end of the extension into the hoist shaft hole on a 45 degree angle downward.
12. Be sure that the socket end of the extension connects to the hoist shaft.

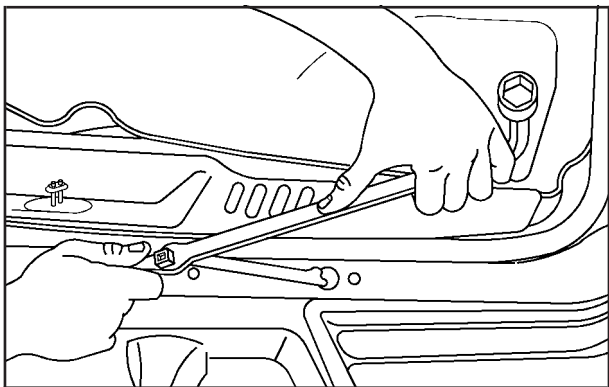

Turn the wheel wrench counterclockwise to lower the spare the rest of the way.

13. Tilt the retainer at the end of the cable and pull it through the wheel opening. Pull the tire out from under the vehicle.

**Notice:** If you drive away before the spare tire or secondary latch system cable has been reinstalled, you could damage your vehicle. Always reinstall this cable before driving your vehicle.

14. Turn the wheel wrench clockwise to raise the cable back up if the cable is hanging under the vehicle.

Have the hoist assembly inspected as soon as you can. You will not be able to store a spare tire using the hoist assembly until it has been repaired or replaced.

## Storing a Flat or Spare Tire and Tools

### CAUTION:

Storing a jack, a tire, or other equipment in the passenger compartment of the vehicle could cause injury. In a sudden stop or collision, loose equipment could strike someone. Store all these in the proper place.

### CAUTION:

The underbody-mounted spare tire needs to be stored with the valve stem pointing up. If the spare tire is stored with the valve stem pointing downward, its secondary latch will not work properly and the spare tire could loosen and suddenly fall from your vehicle. If this happened when your vehicle was being driven, the tire might contact a person or another vehicle, causing injury and, of course, damage to itself as well. Be sure the underbody-mounted spare tire is stored with its valve stem pointing up.

**Notice:** An aluminum wheel with a flat tire should always be stored under the vehicle with the hoist. However, storing it that way for an extended period could damage the wheel. To avoid this, always stow the wheel properly with the valve stem pointing up and have the wheel repaired as soon as possible.

Follow this diagram to store the underbody-mounted flat or spare tire.

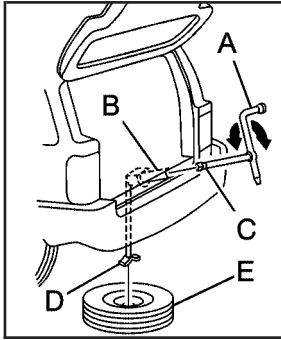

- A. Wheel Wrench
- B. Hoist Shaft
- C. Extension
- D. Retainer
- E. Spare or Flat Tire  
(Valve Stem  
Pointed Up)

1. Put the tire (E) on the ground at the rear of the vehicle.
2. Remove the hubcap, if the vehicle has one, from the flat tire by tapping the backside of the hubcap with the wheel wrench (A). Store in a safe location until the flat tire is repaired. Once the tire is repaired, replace the hubcap.

3. Make sure the valve stem is pointed up and to the rear.
4. Pull the retainer (D) through the wheel.
5. Put the socket end of the extension (C) through the hole just above the rear bumper at a 45 degree angle downward. Connect the socket end of the extension to the hoist shaft (B).
6. Raise the tire fully against the underside of the vehicle. Continue turning the wheel wrench (A) clockwise until you hear two clicks or feel it skip twice. This indicates that the tire is secure and the cable is tight. The spare tire hoist cannot be overtightened.

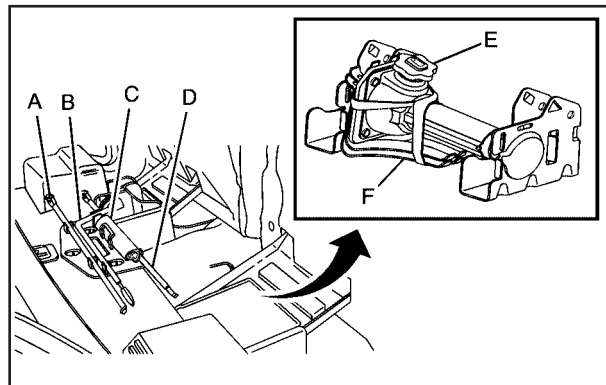
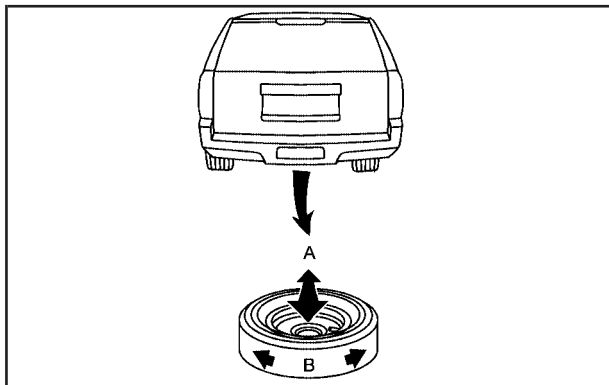

7. Make sure the tire is stored securely. Push, pull (A), and then try to turn (B) the tire. If the tire moves, use the wheel wrench and socket end of the extension to tighten the cable.
8. Return the equipment to the proper location in the vehicle as shown next.

- |                      |                          |
|----------------------|--------------------------|
| A. Handle            | D. Extension(s)          |
| B. Wheel Wrench      | E. Knob                  |
| C. Instruction Label | F. Wheel Blocks and Jack |
1. Attach the handle (A), wheel wrench (B), and extension (D) in the slots provided.
  2. Roll up the instruction label (C) and return to the slot in the tool kit.
  3. Assemble the wheel blocks (F) to the jack.
  4. Turn the knob (E) on the jack clockwise to raise the jack head.
  5. Return the rear seat to its proper position.



## Spare Tire

Your vehicle, when new, had a fully-inflated spare tire. A spare tire may lose air over time, so check its inflation pressure regularly. See *Inflation - Tire Pressure on page 452* and *Loading Your Vehicle on page 350* for information regarding proper tire inflation and loading your vehicle. For instruction on how to remove, install or store a spare tire, see *Removing the Flat Tire and Installing the Spare Tire on page 477* and *Storing a Flat or Spare Tire and Tools on page 486*.

After installing the spare tire on your vehicle, you should stop as soon as possible and make sure the spare is correctly inflated. Have the damaged or flat road tire repaired or replaced as soon as you can and installed back onto your vehicle. This way, a spare tire will be available in case you need it again.

Do not mix tires and wheels of different sizes, because they will not fit. Keep your spare tire and its wheel together.

## Appearance Care

### Cleaning the Inside of Your Vehicle

Your vehicle's interior will continue to look its best if it is cleaned often. Although not always visible, dust and dirt can accumulate on your upholstery. Dirt can damage carpet, fabric, leather, and plastic surfaces. Regular vacuuming is recommended to remove particles from your upholstery. It is important to keep your upholstery from becoming and remaining heavily soiled. Soils should be removed as quickly as possible. Your vehicle's interior may experience extremes of heat that could cause stains to set rapidly.

Lighter colored interiors may require more frequent cleaning. Use care because newspapers and garments that transfer color to your home furnishings may also transfer color to your vehicle's interior.

When cleaning your vehicle's interior, only use cleaners specifically designed for the surfaces being cleaned. Permanent damage may result from using cleaners on surfaces for which they were not intended. Use glass cleaner only on glass.

Remove any accidental over-spray from other surfaces immediately. To prevent over-spray, apply cleaner directly to the cleaning cloth.

**Notice:** If you use abrasive cleaners when cleaning glass surfaces on your vehicle, you could scratch the glass and/or cause damage to the rear window defogger. When cleaning the glass on your vehicle, use only a soft cloth and glass cleaner.

Many cleaners contain solvents that may become concentrated in your vehicle's breathing space. Before using cleaners, read and adhere to all safety instructions on the label. While cleaning your vehicle's interior, maintain adequate ventilation by opening your vehicle's doors and windows.

Dust may be removed from small buttons and knobs using a small brush with soft bristles.

Your GM dealer has a product for cleaning your vehicle's glass. Should it become necessary, you can also obtain a product from your GM dealer to remove odors from your vehicle's upholstery.

Do not clean your vehicle using the following cleaners or techniques:

- Never use a knife or any other sharp object to remove a soil from any interior surface.
- Never use a stiff brush. It can cause damage to your vehicle's interior surfaces.
- Never apply heavy pressure or rub aggressively with a cleaning cloth. Use of heavy pressure can damage your interior and does not improve the effectiveness of soil removal.
- Use only mild, neutral-pH soaps. Avoid laundry detergents or dishwashing soaps with degreasers. Using too much soap will leave a residue that leaves streaks and attracts dirt. For liquid cleaners, about 20 drops per gallon (3.78 L) of water is a good guide.
- Do not heavily saturate your upholstery while cleaning.
- Damage to your vehicle's interior may result from the use of many organic solvents such as naphtha, alcohol, etc.

## Fabric/Carpet

Use a vacuum cleaner with a soft brush attachment frequently to remove dust and loose dirt. A canister vacuum with a beater bar in the nozzle may only be used on floor carpet and carpeted floor mats. For soils, always try to remove them first with plain water or club soda. Before cleaning, gently remove as much of the soil as possible using one of the following techniques:

- For liquids: gently blot the remaining soil with a paper towel. Allow the soil to absorb into the paper towel until no more can be removed.
- For solid dry soils: remove as much as possible and then vacuum.

To clean, use the following instructions:

1. Saturate a lint-free, clean white cloth with water or club soda.
2. Wring the cloth to remove excess moisture.

3. Start on the outside edge of the soil and gently rub toward the center. Continue cleaning, using a clean area of the cloth each time it becomes soiled.
4. Continue to gently rub the soiled area until the cleaning cloth remains clean.
5. If the soil is not completely removed, use a mild soap solution and repeat the cleaning process that was used with plain water.

If any of the soil remains, a commercial fabric cleaner or spot lifter may be necessary. When a commercial upholstery cleaner or spot lifter is to be used, test a small hidden area for colorfastness first. If the locally cleaned area gives any impression that a ring formation may result, clean the entire surface.

After the cleaning process has been completed, a paper towel can be used to blot excess moisture from the fabric or carpet.

## Leather

A soft cloth dampened with water may be used to remove dust. If a more thorough cleaning is necessary, a soft cloth dampened with a mild soap solution can be used. Allow the leather to dry naturally. Do not use heat to dry. Never use steam to clean leather. Never use spot lifters or spot removers on leather. Many commercial leather cleaners and coatings that are sold to preserve and protect leather may permanently change the appearance and feel of your leather and are not recommended. Do not use silicone or wax-based products, or those containing organic solvents to clean your vehicle's interior because they can alter the appearance by increasing the gloss in a non-uniform manner. Never use shoe polish on your leather.

## Instrument Panel, Vinyl, and Other Plastic Surfaces

A soft cloth dampened with water may be used to remove dust. If a more thorough cleaning is necessary, a clean soft cloth dampened with a mild soap solution can be used to gently remove dust and dirt. Never use spot lifters or removers on plastic surfaces. Many commercial cleaners and coatings that are sold to preserve and protect soft plastic surfaces may permanently change the appearance and feel of your interior and are not recommended. Do not use silicone or wax-based products, or those containing organic solvents to clean your vehicle's interior because they can alter the appearance by increasing the gloss in a non-uniform manner.

Some commercial products may increase gloss on your instrument panel. The increase in gloss may cause annoying reflections in the windshield and even make it difficult to see through the windshield under certain conditions.

## Care of Safety Belts

Keep belts clean and dry.

### CAUTION:

**Do not bleach or dye safety belts. If you do, it may severely weaken them. In a crash, they might not be able to provide adequate protection. Clean safety belts only with mild soap and lukewarm water.**

## Weatherstrips

Silicone grease on weatherstrips will make them last longer, seal better, and not stick or squeak. Apply silicone grease with a clean cloth. During very cold, damp weather frequent application may be required. See *Recommended Fluids and Lubricants on page 527*.

## Washing Your Vehicle

The paint finish on the vehicle provides beauty, depth of color, gloss retention, and durability.

The best way to preserve the vehicle's finish is to keep it clean by washing it often with lukewarm or cold water.

Do not wash the vehicle in the direct rays of the sun. Use a car washing soap. Do not use strong soaps or chemical detergents. Be sure to rinse the vehicle well, removing all soap residue completely. Approved cleaning products can be obtained from your dealer. See *Vehicle Care/Appearance Materials on page 498*. Do not use cleaning agents that are petroleum based, or that contain acid or abrasives. All cleaning agents should be flushed promptly and not allowed to dry on the surface, or they could stain. Dry the finish with a soft, clean chamois or an all-cotton towel to avoid surface scratches and water spotting.

High pressure car washes may cause water to enter the vehicle.

## Cleaning Exterior Lamps/Lenses

Use only lukewarm or cold water, a soft cloth and a car washing soap to clean exterior lamps and lenses. Follow instructions under *Washing Your Vehicle* on page 493.

## Finish Care

Occasional waxing or mild polishing of your vehicle by hand may be necessary to remove residue from the paint finish. You can get GM-approved cleaning products from your dealer. See *Vehicle Care/Appearance Materials* on page 498.

If your vehicle has a “basecoat/clearcoat” paint finish, the clearcoat gives more depth and gloss to the colored basecoat. Always use waxes and polishes that are non-abrasive and made for a basecoat/clearcoat paint finish.

**Notice:** Machine compounding or aggressive polishing on a basecoat/clearcoat paint finish may damage it. Use only non-abrasive waxes and polishes that are made for a basecoat/clearcoat paint finish on your vehicle.

Foreign materials such as calcium chloride and other salts, ice melting agents, road oil and tar, tree sap, bird droppings, chemicals from industrial chimneys, etc., can damage your vehicle’s finish if they remain on painted surfaces. Wash the vehicle as soon as possible. If necessary, use non-abrasive cleaners that are marked safe for painted surfaces to remove foreign matter.

Exterior painted surfaces are subject to aging, weather and chemical fallout that can take their toll over a period of years. You can help to keep the paint finish looking new by keeping your vehicle garaged or covered whenever possible.

## Protecting Exterior Bright Metal Parts

Bright metal parts should be cleaned regularly to keep their luster. Washing with water is all that is usually needed. However, you may use chrome polish on chrome or stainless steel trim, if necessary.

Use special care with aluminum trim. To avoid damaging protective trim, never use auto or chrome polish, steam or caustic soap to clean aluminum. A coating of wax, rubbed to high polish, is recommended for all bright metal parts.

## Windshield, Backglass, and Wiper Blades

If the windshield is not clear after using the windshield washer, or if the wiper blade chatters when running, wax, sap or other material may be on the blade or windshield.

Clean the outside of the windshield with a full-strength glass cleaning liquid. The windshield is clean if beads do not form when you rinse it with water.

Grime from the windshield will stick to the wiper blades and affect their performance. Clean the blade by wiping vigorously with a cloth soaked in full-strength windshield washer solvent. Then rinse the blade with water.

Check the wiper blades and clean them as necessary; replace blades that look worn.

## Aluminum Wheels

***Notice:*** If you use strong soaps, chemicals, abrasive polishes, cleaners, brushes, or cleaners that contain acid on aluminum or chrome-plated wheels, you could damage the surface of the wheel(s). The repairs would not be covered by your warranty. Use only GM-approved cleaners on aluminum or chrome-plated wheels.

Keep the wheels clean using a soft clean cloth with mild soap and water. Rinse with clean water. After rinsing thoroughly, dry with a soft clean towel. A wax may then be applied.

***Notice:*** Using chrome polish on aluminum wheels could damage the wheels. The repairs would not be covered by your warranty. Use chrome polish on chrome wheels only.

The surface of these wheels is similar to the painted surface of the vehicle. Do not use strong soaps, chemicals, abrasive polishes, abrasive cleaners, cleaners with acid, or abrasive cleaning brushes on them because the surface could be damaged. Do not use chrome polish on aluminum wheels.

**Notice:** If you drive your vehicle through an automatic car wash that has silicone carbide tire cleaning brushes, you could damage the aluminum or chrome-plated wheels. The repairs would not be covered by your warranty. Never drive a vehicle equipped with aluminum or chrome-plated wheels through an automatic car wash that uses silicone carbide tire cleaning brushes.

Do not take the vehicle through an automatic car wash that has silicone carbide tire cleaning brushes. These brushes can also damage the surface of these wheels.

## Tires

To clean the tires, use a stiff brush with tire cleaner.

**Notice:** Using petroleum-based tire dressing products on your vehicle may damage the paint finish and/or tires. When applying a tire dressing, always wipe off any overspray from all painted surfaces on your vehicle.

## Sheet Metal Damage

If the vehicle is damaged and requires sheet metal repair or replacement, make sure the body repair shop applies anti-corrosion material to parts repaired or replaced to restore corrosion protection.

Original manufacturer replacement parts will provide the corrosion protection while maintaining the warranty.

## Finish Damage

Any stone chips, fractures or deep scratches in the finish should be repaired right away. Bare metal will corrode quickly and may develop into major repair expense.

Minor chips and scratches can be repaired with touch-up materials available from your dealer. Larger areas of finish damage can be corrected in your dealer's body and paint shop.



## Underbody Maintenance

Chemicals used for ice and snow removal and dust control can collect on the underbody. If these are not removed, corrosion and rust can develop on the underbody parts such as fuel lines, frame, floor pan, and exhaust system even though they have corrosion protection.

At least every spring, flush these materials from the underbody with plain water. Clean any areas where mud and debris can collect. Dirt packed in close areas of the frame should be loosened before being flushed. Your dealer or an underbody car washing system can do this for you.

## Chemical Paint Spotting

Some weather and atmospheric conditions can create a chemical fallout. Airborne pollutants can fall upon and attack painted surfaces on the vehicle. This damage can take two forms: blotchy, ring-shaped discolorations, and small, irregular dark spots etched into the paint surface.

Although no defect in the paint job causes this, GM will repair, at no charge to the owner, the surfaces of new vehicles damaged by this fallout condition within 12 months or 12,000 miles (20 000 km) of purchase, whichever occurs first.

## Vehicle Care/Appearance Materials

Description	Usage
Polishing Cloth Wax-Treated	Interior and exterior polishing cloth.
Tar and Road Oil Remover	Removes tar, road oil, and asphalt.
Chrome Cleaner and Polish	Use on chrome or stainless steel.
White Sidewall Tire Cleaner	Removes soil and black marks from whitewalls.
Vinyl Cleaner	Cleans vinyl.
Glass Cleaner	Removes dirt, grime, smoke and fingerprints.
Chrome and Wire Wheel Cleaner	Removes dirt and grime from chrome wheels and wire wheel covers.
Finish Enhancer	Removes dust, fingerprints, and surface contaminants. Spray on and wipe off.

Description	Usage
Swirl Remover Polish	Removes swirl marks, fine scratches, and other light surface contamination.
Cleaner Wax	Removes light scratches and protects finish.
Foaming Tire Shine Low Gloss	Cleans, shines, and protects in one step. No wiping necessary.
Wash Wax Concentrate	Medium foaming shampoo. Cleans and lightly waxes. Biodegradable and phosphate free.
Spot Lifter	Quickly removes spots and stains from carpets, vinyl, and cloth upholstery.
Odor Eliminator	Odorless spray odor eliminator used on fabrics, vinyl, leather and carpet.

# Vehicle Identification

## Vehicle Identification Number (VIN)



This is the legal identifier for your vehicle. It appears on a plate in the front corner of the instrument panel, on the driver's side. You can see it if you look through the windshield from outside your vehicle. The VIN also appears on the Certification/Tire and Service Parts labels and the certificates of title and registration.

## Engine Identification

The eighth character in the VIN is the engine code. This code will help you identify your vehicle's engine, specifications, and replacement parts.

## Service Parts Identification Label

You will find this label on the inside of the glove box. It is very helpful if you ever need to order parts. On this label, you will find the following:

- VIN
- Model designation
- Paint information
- Production options and special equipment

Do not remove this label from the vehicle.

# Electrical System

## Add-On Electrical Equipment

**Notice:** Do not add anything electrical to your vehicle unless you check with your dealer first. Some electrical equipment can damage your vehicle and the damage would not be covered by your warranty. Some add-on electrical equipment can keep other components from working as they should.

Add-on equipment can drain your vehicle's battery, even if your vehicle is not operating.

Your vehicle has an airbag system. Before attempting to add anything electrical to your vehicle, see *Servicing Your Airbag-Equipped Vehicle* on page 88.

## Headlamps

The headlamp wiring is protected by four fuses. An electrical overload will cause a lamp to go on and off. If this happens, have your headlamp wiring checked right away.

## Windshield Wiper Fuses

The windshield wiper motor is protected by a circuit breaker and a fuse. If the motor overheats due to heavy snow or ice, the wiper will stop until the motor cools. If the overload is caused by some electrical problem, be sure to get it fixed.

## Power Windows and Other Power Options

Circuit breakers protect the power windows and other power accessories. When the current load is too heavy, the circuit breaker opens and closes, protecting the circuit until the problem is fixed or goes away.

## Fuses and Circuit Breakers

The wiring circuits in your vehicle are protected from short circuits by a combination of fuses and circuit breakers. This greatly reduces the chance of fires caused by electrical problems.

Look at the silver-colored band inside the fuse. If the band is broken or melted, replace the fuse. Be sure you replace a bad fuse with a new one of the identical size and rating.

If you ever have a problem on the road and don't have a spare fuse, you can borrow one that has the same amperage. Just pick some feature of your vehicle that you can get along without — like the radio or cigarette lighter — and use its fuse, if it is the correct amperage. Replace it as soon as you can.

## Engine Compartment Fuse Block



The fuse block is located under the hood in the engine compartment on the driver's side of the vehicle. See *Engine Compartment Overview on page 392* for more information on location.

Remove the primary cover by pressing the two locking tabs. Remove the secondary cover by snapping off while lifting. To reinstall the fuse panel cover, reverse the sequence.

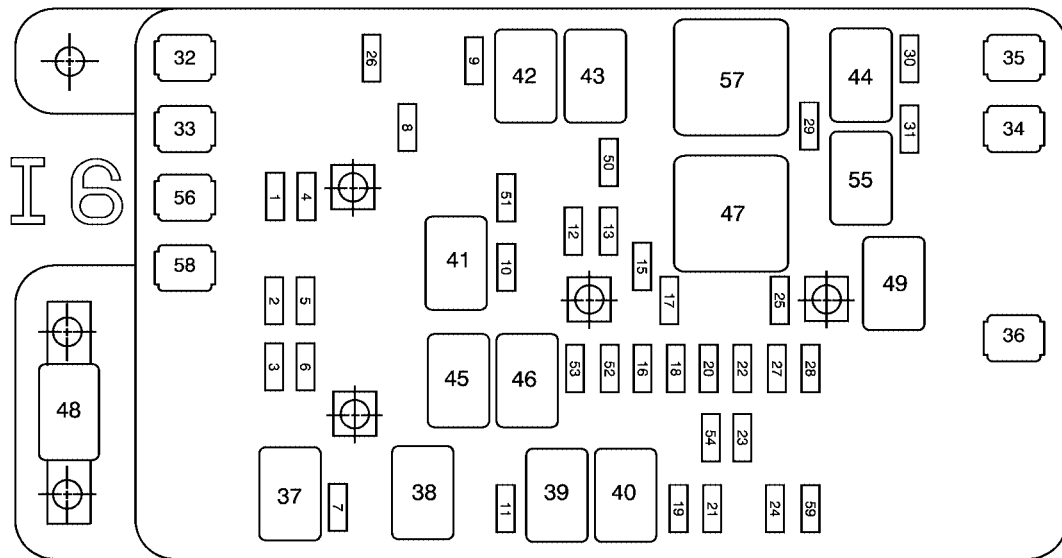

**L6 Engine**

Fuses	Usage
1	Electrically-Controlled Air Suspension
2	Passenger's Side High-Beam Headlamp

Fuses	Usage
3	Passenger's Side Low-Beam Headlamp
4	Back-Up Trailer Lamps

Fuses	Usage
5	Driver's Side High-Beam Headlamp
6	Driver's Side Low-Beam Headlamp
7	Windshield Wiper
8	Automatic Transfer Case
9	Windshield Washer
10	Powertrain Control Module B
11	Fog Lamps
12	Stoplamp
13	Cigarette Lighter
14	Not Used
15	Electric Adjustable Pedal
16	Truck Body Controller, Ignition 1
17	Crank
18	Airbag
19	Trailer Electric Brake
20	Cooling Fan
21	Horn
22	Ignition E
23	Electronic Throttle Control
24	Instrument Panel Cluster, Driver Information Center

Fuses	Usage
25	Automatic Shift Lock Control System
26	Transmission Control Module (TCM) Canister
27	Backup
28	Powertrain Control Module 1
29	Oxygen Sensor
30	Air Conditioning
31	Truck Body Controller 1
32	Trailer
33	Anti-lock Brakes (ABS)
34	Ignition A
35	Blower Motor
36	Ignition B
50	Passenger's Side Trailer Turn
51	Driver's Side Trailer Turn
52	Hazard Flashers
53	Headlamp Driver Module
54	Air Injection Reactor (AIR) Solenoid
56	Air Injection Reactor (AIR) Pump
58	Vehicle Stability Enhancement System (StabiliTrak®)
59	Regulated Voltage Control

<b>Relays</b>	<b>Usage</b>
37	Headlamp Washer
38	Rear Window Wiper/Washer
39	Fog Lamps
40	Horn
41	Fuel Pump
42	Windshield Washer
43	High-Beam Headlamp
44	Air Conditioning
45	Cooling Fan

<b>Relays</b>	<b>Usage</b>
46	Headlamp Driver Module
47	Starter
49	Electric Adjustable Pedal
55	Air Injection Reactor (AIR) Solenoid
57	Powertrain

<b>Miscellaneous</b>	<b>Usage</b>
48	Instrument Panel Battery



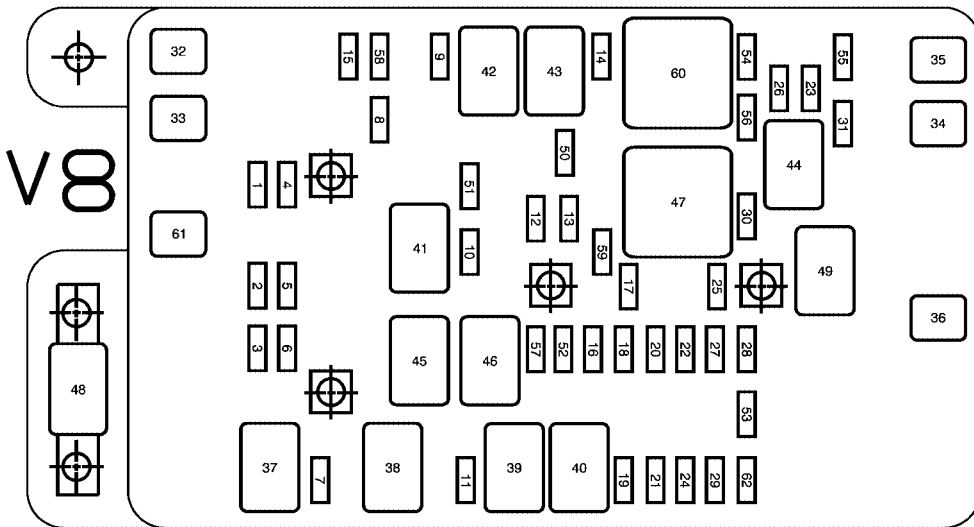

V8 Engine

Fuses	Usage
1	Electrically-Controlled Air Suspension
2	Passenger's Side High-Beam Headlamp

Fuses	Usage
3	Passenger's Side Low-Beam Headlamp
4	Back-Up-Trailer Lamps

Fuses	Usage
5	Driver's Side High-Beam Headlamp
6	Driver's Side Low-Beam Headlamp
7	Windshield Wiper
8	Automatic Transfer Case
9	Windshield Washer
10	Powertrain Control Module B
11	Fog Lamps
12	Stoplamp
13	Cigarette Lighter
14	Ignition Coils
15	Transmission Control Module Canister Vent
16	Truck Body Controller, Ignition 1
17	Crank
18	Airbag
19	Trailer Electric Brake
20	Cooling Fan
21	Horn
22	Ignition E
23	Electronic Throttle Control
24	Instrument Panel Cluster, Driver Information Center

Fuses	Usage
25	Automatic Shift Lock Control System
26	Engine 1
27	Backup
28	Powertrain Control Module 1
29	Powertrain Control Module
30	Air Conditioning
31	Injector Bank A
32	Trailer
33	Anti-lock Brakes (ABS)
34	Ignition A
35	Blower Motor
36	Ignition B
50	Passenger's Side Trailer Turn
51	Driver's Side Trailer Turn
52	Hazard Flashers
53	Transmission
54	Oxygen Sensor Bank B
55	Oxygen Sensor Bank A
56	Injector Bank B
57	Headlamp Driver Module
58	Body Controller 1
59	Electric Adjustable Pedal

Fuses	Usage
61	Vehicle Stability Enhancement System (StabiliTrak®)
62	Regulated Voltage Control

Relays	Usage
37	Headlamp Washer
38	Rear Window Wiper
39	Fog Lamps
40	Horn
41	Fuel Pump
42	Windshield Washer
43	High-Beam Headlamp
44	Air Conditioning
45	Cooling Fan
46	Headlamp Driver Module
47	Starter
49	Electric Adjustable Pedal
60	Powertrain

Miscellaneous	Usage
48	Instrument Panel Battery

## Rear Underseat Fuse Block

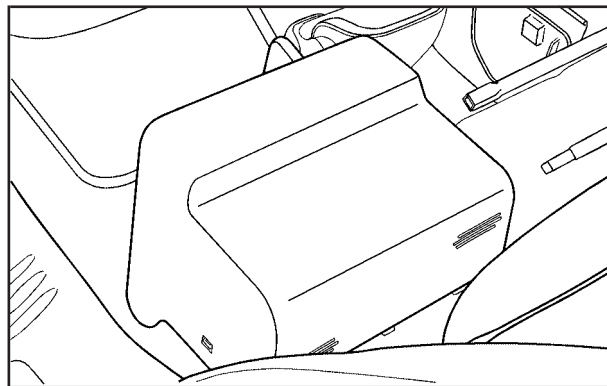

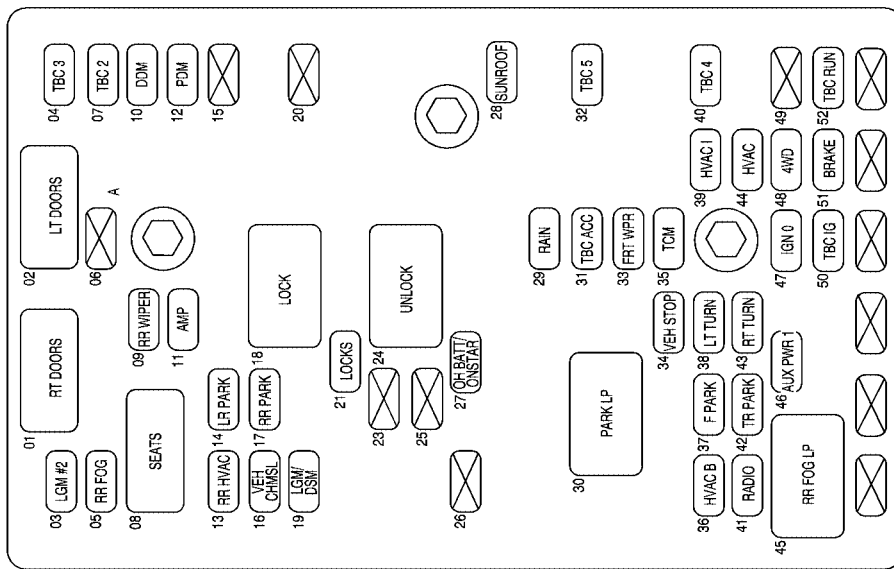

Fuses	Usage
01	Passenger Door Control Module
02	Driver Door Control Module
03	Liftgate Module 2
04	Truck Body Controller 3

Fuses	Usage
05	Rear Fog Lamps
06	Blank
07	Truck Body Controller 2
08	Power Seats

Fuses	Usage
09	Rear Wiper
10	Driver Door Module
11	Amplifier
12	Passenger Door Module
13	Rear Climate Controls
14	Driver Side Rear Parking Lamps
15	Blank
16	Vehicle Center High-Mounted Stoplamp (CHMSL)
17	Passenger Side Rear Parking Lamps
18	Locks
19	Liftgate Module/Driver Seat Module
20	Blank
21	Lock
23	Blank
24	Unlock
25	Blank
26	Blank
27	OnStar® Overhead Battery, OnStar® System
28	Sunroof
29	Rainsense™ Wipers

Fuses	Usage
30	Parking Lamps
31	Truck Body Controller Accessory
32	Truck Body Controller 5
33	Front Wipers
34	Vehicle Stop
35	Transmission Control Module
36	Heat Ventilation Air Conditioning B
37	Front Parking Lamps
38	Driver Side Turn Signal
39	Heat Ventilation Air Conditioning 1
40	Truck Body Controller 4
41	Radio
42	Trailer Park
43	Passenger Side Turn Signal
44	Heat Ventilation Air Conditioning
45	Rear Fog Lamps
46	Auxiliary Power 1
47	Ignition 0
48	Four-Wheel Drive
49	Blank
50	Truck Body Controller Ignition
51	Brakes
52	Truck Body Controller Run

## Capacities and Specifications

The following approximate capacities are given in English and metric conversions. See *Recommended Fluids and Lubricants* on page 527 for more information.

Application	Capacities	
	English	Metric
Air Conditioning Refrigerant R134a	For the air conditioning system refrigerant charge amount, see the refrigerant caution label located under the hood. See your dealer for more information.	
Cooling System		
4.2L L6	10.8 qt	10.2 L
5.3L V8	12.2 qt	11.6 L
6.0L V8	12.2 qt	11.6 L
Engine Oil with Filter		
4.2L L6	7.0 qt	6.6 L
5.3L V8	6.0 qt	5.7 L
6.0L V8	6.0 qt	5.7 L
Fuel Tank	22.0 gal	83.3 L
Transfer Case Lubricant	2.0 qt	1.8 L
Transmission (Drain and Refill)	5.0 qt	4.7 L
Wheel Nut Torque	100 lb ft	140 N•m
All capacities are approximate. When adding, be sure to fill to the appropriate level, as recommended in this manual. Recheck the fluid level after filling.		

## Engine Specifications

Engine	VIN Code	Transmission	Spark Plug Gap
VORTEC™ 4.2L L6	S	Automatic	0.040 inches (1.01 mm)
VORTEC™ 5.3L V8	M	Automatic	0.040 inches (1.01 mm)
6.0L V8	H	Automatic	0.040 inches (1.01 mm)

 **NOTES**

---

---

---

---

---

---

---

---

---

---

---

---

---

---

---

---

---

---

---

---

---

---

---

---

---



## Section 6 Maintenance Schedule

---

<b>Maintenance Schedule</b> .....	514	Owner Checks and Services .....	523
Introduction .....	514	At Each Fuel Fill .....	523
Maintenance Requirements .....	514	At Least Once a Month .....	524
Your Vehicle and the Environment .....	515	At Least Once a Year .....	524
Using the Maintenance Schedule .....	515	Recommended Fluids and Lubricants .....	527
Scheduled Maintenance .....	517	Normal Maintenance Replacement Parts .....	530
Additional Required Services .....	520	Engine Drive Belt Routing .....	531
Maintenance Footnotes .....	521	Maintenance Record .....	532

# Maintenance Schedule

## Introduction

**Important:** Keep engine oil at the proper level and change as recommended.



*Have you purchased the GM Protection Plan? The Plan supplements your new vehicle warranties. See your Warranty and Owner Assistance booklet or your dealer for details.*

# Maintenance Requirements

**Notice:** Maintenance intervals, checks, inspections, replacement parts, and recommended fluids and lubricants as prescribed in this manual are necessary to keep your vehicle in good working condition. Any damage caused by failure to follow scheduled maintenance may not be covered by warranty.

## Your Vehicle and the Environment

Proper vehicle maintenance not only helps to keep your vehicle in good working condition, but also helps the environment. All recommended maintenance is important. Improper vehicle maintenance can even affect the quality of the air we breathe. Improper fluid levels or the wrong tire inflation can increase the level of emissions from your vehicle. To help protect our environment, and to keep your vehicle in good condition, be sure to maintain your vehicle properly.

## Using the Maintenance Schedule

We at General Motors want to help you keep your vehicle in good working condition. But we do not know exactly how you will drive it. You may drive very short distances only a few times a week. Or you may drive long distances all the time in very hot, dusty weather. You may use your vehicle in making deliveries. Or you may drive it to work, to do errands, or in many other ways.

Because of all the different ways people use their vehicles, maintenance needs vary. You may need more frequent checks and replacements. So please read the following and note how you drive. If you have any questions on how to keep your vehicle in good condition, see your GM Goodwrench® dealer.

This schedule is for vehicles that:

- carry passengers and cargo within recommended limits. You will find these limits on the Tire and Loading Information label. See *Loading Your Vehicle on page 350*.
- are driven on reasonable road surfaces within legal driving limits.
- are driven off-road in the recommended manner. See *Off-Road Driving (Except SS) on page 317*.
- use the recommended fuel. See *Gasoline Octane on page 384*.

The services in *Scheduled Maintenance on page 517* should be performed when indicated. See *Additional Required Services on page 520* and *Maintenance Footnotes on page 521* for further information.

 **CAUTION:**

**Performing maintenance work on a vehicle can be dangerous. In trying to do some jobs, you can be seriously injured. Do your own maintenance work only if you have the required know-how and the proper tools and equipment for the job. If you have any doubt, see your GM Goodwrench® dealer to have a qualified technician do the work. See *Doing Your Own Service Work on page 383*.**

Some maintenance services can be complex. So, unless you are technically qualified and have the necessary equipment, you should have your GM Goodwrench® dealer do these jobs.

When you go to your GM Goodwrench® dealer for your service needs, you will know that GM-trained and supported service technicians will perform the work using genuine GM parts.

If you want to purchase service information, see *Service Publications Ordering Information on page 555*.

*Owner Checks and Services on page 523* tells you what should be checked, when to check it, and what you can easily do to help keep your vehicle in good condition.

The proper replacement parts, fluids, and lubricants to use are listed in *Recommended Fluids and Lubricants on page 527* and *Normal Maintenance Replacement Parts on page 530*. When your vehicle is serviced, make sure these are used. All parts should be replaced and all necessary repairs done before you or anyone else drives the vehicle. We recommend the use of genuine GM parts.

## Scheduled Maintenance

When the change engine oil light or CHANGE ENGINE OIL DIC message comes on, it means that service is required for your vehicle. See *Change Engine Oil Light on page 212* or *DIC Warnings and Messages on page 220*. Have your vehicle serviced as soon as possible within the next 600 miles (1 000 km). It is possible that, if you are driving under the best conditions, the engine oil life system may not indicate that vehicle service is necessary for over a year. However, your engine oil and filter must be changed at least once a year and at this time the system must be reset. Your GM Goodwrench® dealer has GM-trained service technicians who will perform this work using genuine GM parts and reset the system.

If the engine oil life system is ever reset accidentally, you must service your vehicle within 3,000 miles (5 000 km) since your last service. Remember to reset the oil life system whenever the oil is changed. See *Engine Oil Life System on page 404* for information on the Engine Oil Life System and resetting the system.

When the change engine oil light or CHANGE ENGINE OIL DIC message appears, certain services, checks, and inspections are required. Required services are described in the following for “Maintenance I” and “Maintenance II.” Generally, it is recommended that your first service be Maintenance I, your second service be Maintenance II, and that you alternate Maintenance I and Maintenance II thereafter. However, in some cases, Maintenance II may be required more often.

**Maintenance I** — Use Maintenance I if the light or message comes on within 10 months since the vehicle was purchased or Maintenance II was performed.

**Maintenance II** — Use Maintenance II if the previous service performed was Maintenance I. Always use Maintenance II whenever the light or message comes on 10 months or more since the last service or if the light or message has not come on at all for one year.

## Scheduled Maintenance

Service	Maintenance I	Maintenance II
Change engine oil and filter. See <i>Engine Oil on page 398</i> . Reset oil life system. See <i>Engine Oil Life System on page 404</i> . An <i>Emission Control Service</i> .	•	•
Visually check for any leaks or damage. See <i>footnote (j)</i> .	•	•
Inspect engine air cleaner filter. If necessary, replace filter. See <i>Engine Air Cleaner/Filter on page 406</i> . See <i>footnote (k)</i> .		•
Rotate tires and check inflation pressures and wear. See <i>Tire Inspection and Rotation on page 460</i> and “Tire Wear Inspection” in <i>At Least Once a Month on page 524</i> .	•	•
Inspect brake system. See <i>footnote (a)</i> .	•	•
Check engine coolant and windshield washer fluid levels and add fluid as needed.	•	•
Perform any needed additional services. See “Additional Required Services” in this section.	•	•
Inspect suspension and steering components. See <i>footnote (b)</i> .		•
Inspect engine cooling system. See <i>footnote (c)</i> .		•
Inspect wiper blades. See <i>footnote (d)</i> .		•
Inspect restraint system components. See <i>footnote (e)</i> .		•
Lubricate body components. See <i>footnote (f)</i> .		•
Check transmission fluid level and add fluid as needed. See <i>footnote (g)</i> .		•

## Additional Required Services

The following services should be performed at the first maintenance service (I or II) after the indicated miles (kilometers) shown for each item.

### Additional Required Services

Service and Miles (Kilometers)	25,000 (40 000)	50,000 (80 000)	75,000 (120 000)	100,000 (160 000)	125,000 (200 000)	150,000 (240 000)
Inspect fuel system for damage or leaks.	•	•	•	•	•	•
Inspect exhaust system for loose or damaged components.	•	•	•	•	•	•
Replace engine air cleaner filter. See <i>Engine Air Cleaner/Filter on page 406.</i>		•		•		•
Change automatic transmission fluid and filter (severe service). See footnotes (g) and (h).		•		•		•
Change automatic transmission fluid and filter (normal service). See footnote (g).				•		
Automatic transfer case only: Change transfer case fluid. See footnote (g).		•		•		•
Replace spark plugs. An <i>Emission Control Service.</i>				•		



### Additional Required Services (cont'd)

Service and Miles (Kilometers)	25,000 (40 000)	50,000 (80 000)	75,000 (120 000)	100,000 (160 000)	125,000 (200 000)	150,000 (240 000)
V8 engine only: Inspect spark plug wires. <i>An Emission Control Service.</i>				•		
Engine cooling system service (or every five years, whichever occurs first). <i>An Emission Control Service. See footnote (i).</i>						•
Inspect engine accessory drive belt. <i>An Emission Control Service. See footnote (l).</i>						•

### Maintenance Footnotes

(a) *Visually inspect brake lines and hoses for proper hook-up, binding, leaks, cracks, chafing, etc. Inspect disc brake pads for wear and rotors for surface condition. Inspect other brake parts, including calipers, parking brake, etc.*

(b) *Visually inspect front and rear suspension and steering system for damaged, loose, or missing parts or signs of wear. Inspect power steering lines and hoses for proper hook-up, binding, leaks, cracks, chafing, etc.*

(c) *Visually inspect hoses and have them replaced if they are cracked, swollen, or deteriorated. Inspect all pipes, fittings and clamps; replace with genuine GM parts as needed. To help ensure proper operation, a pressure test of the cooling system and pressure cap and cleaning the outside of the radiator and air conditioning condenser is recommended at least once a year.*

(d) *Visually inspect wiper blades for wear or cracking. Replace wiper blades that appear worn or damaged or that streak or miss areas of the windshield.*

(e) *Make sure the safety belt reminder light and all your belts, buckles, latch plates, retractors, and anchorages are working properly. Look for any other loose or damaged safety belt system parts. If you see anything that might keep a safety belt system from doing its job, have it repaired. Have any torn or frayed safety belts replaced. Also look for any opened or broken airbag coverings, and have them repaired or replaced. The airbag system does not need regular maintenance.*

(f) *Lubricate all key lock cylinders, hood latch assembly, secondary latch, pivots, spring anchor, release pawl, rear compartment hinges, outer liftgate handle pivot points, rear door detent link, roller mechanism, liftgate handle pivot points, latch bolt, fuel door hinge, cargo door hinge, locks, and folding seat hardware. More frequent lubrication may be required when exposed to a corrosive environment. Applying silicone grease on weatherstrips with a clean cloth will make them last longer, seal better, and not stick or squeak.*

(g) *Inspect hoses for cracks, chafing, leaks, kinks, and proper installation.*

(h) *Change automatic transmission fluid and filter if the vehicle is mainly driven under one or more of these conditions:*

- In heavy city traffic where the outside temperature regularly reaches 90°F (32°C) or higher.*
- In hilly or mountainous terrain.*
- When doing frequent trailer towing.*
- Uses such as found in taxi, police, or delivery service.*

(i) *Drain, flush, and refill cooling system. This service can be complex; you should have your dealer perform this service. See Engine Coolant on page 411 for what to use. Inspect hoses. Clean radiator, condenser, pressure cap, and filler neck. Pressure test the cooling system and pressure cap.*

(j) *A fluid loss in any vehicle system could indicate a problem. Have the system inspected and repaired and the fluid level checked. Add fluid if needed.*

(k) *If you drive regularly under dusty conditions, inspect the filter at each engine oil change.*

(l) *Visually inspect belt for fraying, excessive cracks, or obvious damage. Replace belt if necessary.*

## Owner Checks and Services

These owner checks and services should be performed at the intervals specified to help ensure the safety, dependability, and emission control performance of your vehicle. Your GM Goodwrench<sup>®</sup> dealer can assist you with these checks and services.

Be sure any necessary repairs are completed at once. Whenever any fluids or lubricants are added to your vehicle, make sure they are the proper ones, as shown in *Recommended Fluids and Lubricants on page 527*.

## At Each Fuel Fill

*It is important to perform these underhood checks at each fuel fill.*

### Engine Oil Level Check

Check the engine oil level and add the proper oil if necessary. See *Engine Oil on page 398* for further details.

**Notice:** It is important to check your oil regularly and keep it at the proper level. Failure to keep your engine oil at the proper level can cause damage to your engine not covered by your warranty.

### Engine Coolant Level Check

Check the engine coolant level and add DEX-COOL<sup>®</sup> coolant mixture if necessary. See *Engine Coolant on page 411* for further details.

### Windshield Washer Fluid Level Check

Check the windshield washer fluid level in the windshield washer fluid reservoir and add the proper fluid if necessary.

## At Least Once a Month

### Tire Inflation Check

Visually inspect your vehicle's tires and make sure they are inflated to the correct pressures. Do not forget to check the spare tire. See *Inflation - Tire Pressure on page 452*. Check to make sure the spare tire is stored securely. See *Changing a Flat Tire on page 472*.

### Tire Wear Inspection

Tire rotation may be required for high mileage highway drivers prior to the Engine Oil Life System service notification. Check the tires for wear and, if necessary, rotate the tires. See *Tire Inspection and Rotation on page 460*.

## At Least Once a Year

### Starter Switch Check

#### CAUTION:

**When you are doing this inspection, the vehicle could move suddenly. If the vehicle moves, you or others could be injured.**

1. Before you start, be sure you have enough room around the vehicle.
2. Firmly apply both the parking brake and the regular brake. See *Parking Brake on page 126*. Do not use the accelerator pedal, and be ready to turn off the engine immediately if it starts.
3. Try to start the engine in each gear. The vehicle should start only in PARK (P) or NEUTRAL (N). If the vehicle starts in any other position, contact your GM Goodwrench<sup>®</sup> dealer for service.

## Automatic Transmission Shift Lock Control System Check

### CAUTION:

**When you are doing this inspection, the vehicle could move suddenly. If the vehicle moves, you or others could be injured.**

1. Before you start, be sure you have enough room around the vehicle. It should be parked on a level surface.
2. Firmly apply the parking brake. See *Parking Brake on page 126*.

Be ready to apply the regular brake immediately if the vehicle begins to move.

3. With the engine off, turn the ignition to RUN, but do not start the engine. Without applying the regular brake, try to move the shift lever out of PARK (P) with normal effort. If the shift lever moves out of PARK (P), contact your GM Goodwrench<sup>®</sup> dealer for service.

## Ignition Transmission Lock Check

While parked, and with the parking brake set, try to turn the ignition to LOCK in each shift lever position.

- The ignition should turn to LOCK only when the shift lever is in PARK (P).
- The ignition key should come out only in LOCK.

Contact your GM Goodwrench<sup>®</sup> dealer if service is required.

## Parking Brake and Automatic Transmission Park (P) Mechanism Check

### CAUTION:

**When you are doing this check, your vehicle could begin to move. You or others could be injured and property could be damaged. Make sure there is room in front of your vehicle in case it begins to roll. Be ready to apply the regular brake at once should the vehicle begin to move.**

Park on a fairly steep hill, with the vehicle facing downhill. Keeping your foot on the regular brake, set the parking brake.

- To check the parking brake's holding ability: With the engine running and transmission in NEUTRAL (N), slowly remove foot pressure from the regular brake pedal. Do this until the vehicle is held by the parking brake only.
- To check the PARK (P) mechanism's holding ability: With the engine running, shift to PARK (P). Then release the parking brake followed by the regular brake.

Contact your GM Goodwrench<sup>®</sup> dealer if service is required.

### Underbody Flushing Service

At least every spring, use plain water to flush any corrosive materials from the underbody. Take care to clean thoroughly any areas where mud and other debris can collect.

## Recommended Fluids and Lubricants

Fluids and lubricants identified below by name, part number, or specification may be obtained from your dealer.

Usage	Fluid/Lubricant
Engine Oil (Except 6.0L V8 Engine)	Engine oil which meets GM Standard GM6094M and displays the American Petroleum Institute Certified for Gasoline Engines starburst symbol. GM Goodwrench <sup>®</sup> oil meets all the requirements for your vehicle. To determine the proper viscosity for your vehicle's engine, see <i>Engine Oil on page 398</i> .

Usage	Fluid/Lubricant
Engine Oil (6.0L V8 Engine Only)	The engine requires a special engine oil meeting GM Standard GM4718M. Oils meeting this standard may be identified as synthetic, and should also be identified with the American Petroleum Institute Certified for Gasoline Engines starburst symbol. However, not all synthetic API oils with the starburst symbol will meet this GM standard. You should look for and use only an oil that meets GM Standard GM4718M. GM Goodwrench <sup>®</sup> oil meets all the requirements for your vehicle. For the proper viscosity, see <i>Engine Oil on page 398</i> .
Engine Coolant	50/50 mixture of clean, drinkable water and use only DEX-COOL <sup>®</sup> Coolant. See <i>Engine Coolant on page 411</i> .
Hydraulic Brake System	Delco <sup>®</sup> Supreme 11 Brake Fluid or equivalent DOT-3 brake fluid.

Usage	Fluid/Lubricant
Windshield Washer	GM Optikleen® Washer Solvent.
Parking Brake Cable Guides	Chassis Lubricant (GM Part No. U.S. 12377985, in Canada 88901242) or lubricant meeting requirements of NLGI #2, Category LB or GC-LB.
Power Steering System	GM Power Steering Fluid (GM Part No. U.S. 89021184, in Canada 89021186).
Automatic Transmission	DEXRON®-VI Automatic Transmission Fluid.
Key Lock Cylinders	Multi-Purpose Lubricant, Superlube (GM Part No. U.S. 12346241, in Canada 10953474).
Chassis Lubrication	Chassis Lubricant (GM Part No. U.S. 12377985, in Canada 88901242) or lubricant meeting requirements of NLGI #2, Category LB or GC-LB.
Front Axle	SAE 75W-90 Synthetic Axle Lubricant (GM Part No. U.S. 12378261, in Canada 10953455) meeting GM Specification 9986115.

Usage	Fluid/Lubricant
Rear Axle (Except SS Model)	SAE 75W-90 Synthetic Axle Lubricant (GM Part No. U.S. 12378261, in Canada 10953455) meeting GM Specification 9986115.
Rear Axle (SS Model)	SAE 75W-90 Synthetic Axle Lubricant (GM Part No. U.S. 12378261, in Canada 10953455) meeting GM Specification 9986115. With a complete drain and refill add 4 ounces (118 ml) of Limited-Slip Axle Lubricant Additive (GM Part No. U.S. 1052358, in Canada 992694) where required. See <i>Rear Axle on page 434</i> .
Transfer Case	AUTO-TRAK II Fluid (GM Part No. U.S. 12378508, in Canada 10953626).
Rear Driveline Center Spline and Universal Joints	Chassis Lubricant (GM Part No. U.S. 12377985, in Canada 88901242) or lubricant meeting requirements of NLGI #2, Category LB or GC-LB.



Usage	Fluid/Lubricant
Constant Velocity Universal Joint	Chassis Lubricant (GM Part No. U.S. 12377985, in Canada 88901242) or lubricant meeting requirements of NLGI #2, Category LB or GC-LB.
Hood Latch Assembly, Secondary Latch, Pivots, Spring Anchor, and Release Pawl	Lubriplate Lubricant Aerosol (GM Part No. U.S. 12346293, in Canada 992723) or lubricant meeting requirements of NLGI #2, Category LB or GC-LB.
Hood and Door Hinges, Body Door Hinge Pins, Liftgate Hinge and Linkage, Folding Seats, and Fuel Door Hinge	Multi-Purpose Lubricant, Superlube (GM Part No. U.S. 12346241, in Canada 10953474).

Usage	Fluid/Lubricant
Outer Tailgate Handle Pivot Points and Hinges	Multi-Purpose Lubricant, Superlube (GM Part No. U.S. 12346241, in Canada 10953474).
Weatherstrip Conditioning	Weatherstrip Lubricant (GM Part No. U.S. 3634770, in Canada 10953518) or Dielectric Silicone Grease (GM Part No. U.S. 12345579, in Canada 992887).
Weatherstrip Squeaks	Synthetic Grease with Teflon, Superlube (GM Part No. U.S. 12371287, in Canada 10953437).

## Normal Maintenance Replacement Parts

Replacement parts identified below by name, part number, or specification can be obtained from your dealer.

Part	GM Part Number	ACDelco® Part Number
Automatic Transmission Filter Kit	24208576	TF337
Engine Air Cleaner/Filter	15036141	A2014C
Engine Oil Filter		
4.2 L6	89017342	PF61
5.3 V8	89017524	PF48
6.0 V8	89017524	PF48
Spark Plugs		
4.2 L6	12598004	41-103
5.0 V8	12571164	41-985
6.0 V8	12571164	41-985
Wiper Blades		
Front – 22 inches (56 cm)	15214346	—
Rear – 16 inches (41 cm)	15160740	—

## Engine Drive Belt Routing

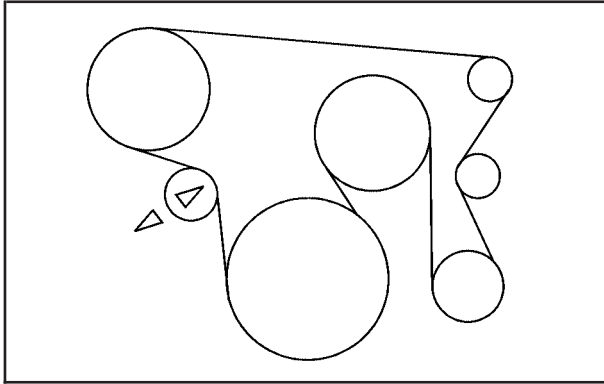

4.2L V6 Engine

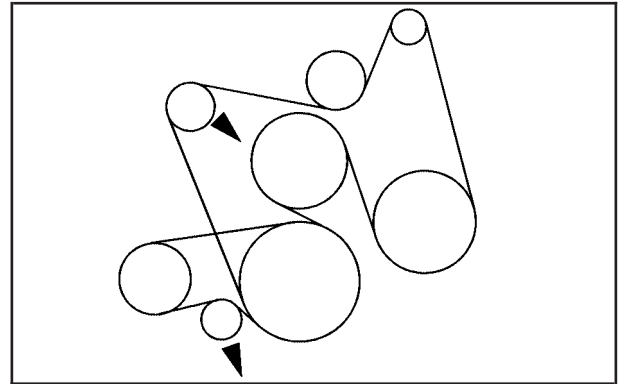

5.3L V8 and 6.0L V8 Engines

## Maintenance Record

After the scheduled services are performed, record the date, odometer reading, who performed the service, and the type of services performed in the boxes provided. See *Maintenance Requirements on page 514*. Any additional information from *Owner Checks and Services on page 523* can be added on the following record pages. You should retain all maintenance receipts.

### Maintenance Record

Date	Odometer Reading	Serviced By	Maintenance I or Maintenance II	Services Performed

### Maintenance Record (cont'd)

Date	Odometer Reading	Serviced By	Maintenance I or Maintenance II	Services Performed

Information Provided by:



### Maintenance Record (cont'd)

Date	Odometer Reading	Serviced By	Maintenance I or Maintenance II	Services Performed

## Section 7 Customer Assistance Information

---

<b>Customer Assistance and Information</b> .....	536	<b>Reporting Safety Defects</b> .....	554
Customer Satisfaction Procedure .....	536	Reporting Safety Defects to the	
Online Owner Center .....	539	United States Government .....	554
Customer Assistance for Text		Reporting Safety Defects to the	
Telephone (TTY) Users .....	540	Canadian Government .....	554
Customer Assistance Offices .....	540	Reporting Safety Defects to	
GM Mobility Reimbursement Program .....	541	General Motors .....	554
Roadside Assistance Program .....	542	Service Publications Ordering	
Courtesy Transportation .....	545	Information .....	555
Vehicle Data Collection and Event			
Data Recorders .....	548		
Collision Damage Repair .....	549		

# Customer Assistance and Information

## Customer Satisfaction Procedure

Your satisfaction and goodwill are important to your dealer and to Chevrolet. Normally, any concerns with the sales transaction or the operation of your vehicle will be resolved by your dealer's sales or service departments. Sometimes, however, despite the best intentions of all concerned, misunderstandings can occur. If your concern has not been resolved to your satisfaction, the following steps should be taken:

**STEP ONE:** Discuss your concern with a member of dealership management. Normally, concerns can be quickly resolved at that level. If the matter has already been reviewed with the sales, service, or parts manager, contact the owner of the dealership or the general manager.

**STEP TWO:** If after contacting a member of dealership management, it appears your concern cannot be resolved by the dealership without further help, in the U.S., contact the Chevrolet Customer Assistance Center by calling 1-800-222-1020. In Canada, contact General Motors of Canada Customer Communication Centre by calling 1-800-263-3777 (English) or 1-800-263-7854 (French).

We encourage you to call the toll-free number in order to give your inquiry prompt attention. Please have the following information available to give the Customer Assistance Representative:

- Vehicle Identification Number (VIN). This is available from the vehicle registration or title, or the plate at the top left of the instrument panel and visible through the windshield.
- Dealership name and location.
- Vehicle delivery date and present mileage (kilometers).



When contacting Chevrolet, please remember that your concern will likely be resolved at a dealer's facility. That is why we suggest you follow Step One first if you have a concern.

**STEP THREE — U.S. Owners:** Both General Motors and your dealer are committed to making sure you are completely satisfied with your new vehicle. However, if you continue to remain unsatisfied after following the procedure outlined in Steps 1 and 2, you should file with the BBB Auto Line Program to enforce your rights.

The BBB Auto Line Program is an out of court program administered by the Council of Better Business Bureaus to settle automotive disputes regarding vehicle repairs or the interpretation of the New Vehicle Limited Warranty. Although you may be required to resort to this informal dispute resolution program prior to filing a court action, use of the program is free of charge and your case will generally be heard within 40 days. If you do not agree with the decision given in your case, you may reject it and proceed with any other venue for relief available to you.

You may contact the BBB Auto Line Program using the toll-free telephone number or write them at the following address:

BBB Auto Line Program  
Council of Better Business Bureaus, Inc.  
4200 Wilson Boulevard  
Suite 800  
Arlington, VA 22203-1838

Telephone: 1-800-955-5100

This program is available in all 50 states and the District of Columbia. Eligibility is limited by vehicle age, mileage, and other factors. General Motors reserves the right to change eligibility limitations and/or discontinue its participation in this program.

**STEP THREE — Canadian Owners:** In the event that you do not feel your concerns have been addressed after following the procedure outlined in Steps 1 and 2, General Motors of Canada Limited wants you to be aware of its participation in a no-charge Mediation/Arbitration Program. General Motors of Canada Limited has committed to binding arbitration of owner disputes involving factory-related vehicle service claims. The program provides for the review of the facts involved by an impartial third party arbiter, and may include an informal hearing before the arbiter. The program is designed so that the entire dispute settlement process, from the time you file your complaint to the final decision, should be completed in approximately 70 days. We believe our impartial program offers advantages over courts in most jurisdictions because it is informal, quick, and free of charge.

For further information concerning eligibility in the Canadian Motor Vehicle Arbitration Plan (CAMVAP), call toll-free 1-800-207-0685. Alternatively, you may call the General Motors Customer Communication Centre, 1-800-263-3777 (English), 1-800-263-7854 (French), or you may write to:

The Mediation/Arbitration Program  
c/o Customer Communication Centre  
General Motors of Canada Limited  
Mail Code: CA1-163-005  
1908 Colonel Sam Drive  
Oshawa, Ontario L1H 8P7

Your inquiry should be accompanied by your Vehicle Identification Number (VIN).

## Online Owner Center

### Online Owner Center (United States only)

The Owner Center is a resource for your GM ownership needs. Specific vehicle information can be found in one place.

#### The Online Owner Center allows you to:

- Get e-mail service reminders.
- Access information about your specific vehicle, including tips and videos and an electronic version of this owner manual.
- Keep track of your vehicle's service history and maintenance schedule.
- Find GM dealers for service nationwide.
- Receive special promotions and privileges only available to members.

Refer to [www.MyGMLink.com](http://www.MyGMLink.com) on the web for updated information and to register your vehicle.

## My GM Canada (Canada only)

My GM Canada is a password-protected section of [gmcanada.com](http://gmcanada.com) where you can save information on GM vehicles, get personalized offers, and use handy tools and forms with greater ease.

Here are a few of the valuable tools and services you will have access to:

- My Showroom: Find and save information on vehicles and current offers in your area.
- My Dealers/Retailers: Save details such as address and phone number for each of your preferred GM Dealers or Retailers.
- My Driveway: Receive service reminders and helpful advice on owning and maintaining your vehicle.
- My Preferences: Manage your profile, subscribe to E-News and use tools and forms with greater ease.

To sign up to My GM Canada, visit the My GM Canada section within [www.gmcanada.com](http://www.gmcanada.com).

## Customer Assistance for Text Telephone (TTY) Users

To assist customers who are deaf, hard of hearing, or speech-impaired and who use Text Telephones (TTYs), Chevrolet has TTY equipment available at its Customer Assistance Center. Any TTY user in the U.S. can communicate with Chevrolet by dialing: 1-800-833-CHEV (2438). (TTY users in Canada can dial 1-800-263-3830.)

## Customer Assistance Offices

Chevrolet encourages customers to call the toll-free number for assistance. However, if a customer wishes to write or e-mail Chevrolet, the letter should be addressed to:

### United States — Customer Assistance

Chevrolet Motor Division  
Chevrolet Customer Assistance Center  
P.O. Box 33170  
Detroit, MI 48232-5170

[www.Chevrolet.com](http://www.Chevrolet.com)  
1-800-222-1020  
1-800-833-2438 (For Text Telephone devices (TTYs))

Roadside Assistance: 1-800-CHEV-USA  
(243-8872)

Fax Number: 313-381-0022

From Puerto Rico:

1-800-496-9992 (English)

1-800-496-9993 (Spanish)

Fax Number: 313-381-0022

From U.S. Virgin Islands:

1-800-496-9994

Fax Number: 313-381-0022

### Canada — Customer Assistance

General Motors of Canada Limited  
Customer Communication Centre, CA1-163-005  
1908 Colonel Sam Drive  
Oshawa, Ontario L1H 8P7

[www.gmcanada.com](http://www.gmcanada.com)

1-800-263-3777 (English)

1-800-263-7854 (French)

1-800-263-3830 (For Text Telephone devices (TTYs))

Roadside Assistance: 1-800-268-6800

## Overseas — Customer Assistance

Please contact the local General Motors Business Unit.

## Mexico, Central America and Caribbean Islands/Countries (Except Puerto Rico and U.S. Virgin Islands) — Customer Assistance

General Motors de Mexico, S. de R.L. de C.V.  
Customer Assistance Center  
Paseo de la Reforma # 2740  
Col. Lomas de Bezares  
C.P. 11910, Mexico, D.F.  
01-800-508-0000  
Long Distance: 011-52-53 29 0 800

## GM Mobility Reimbursement Program



This program, available to qualified applicants, can reimburse you up to \$1,000 of the cost of eligible aftermarket adaptive equipment required for your vehicle, such as hand controls or a wheelchair/scooter lift.

The offer is available for a very limited period of time from the date of vehicle purchase/lease. For more details, or to determine your vehicle's eligibility, visit [gmmobility.com](http://gmmobility.com) or call the GM Mobility Assistance Center at 1-800-323-9935. Text telephone (TTY) users, call 1-800-833-9935.

General Motors of Canada also has a Mobility Program. Call 1-800-GM-DRIVE (463-7483) for details. TTY users call 1-800-263-3830.

## Roadside Assistance Program

In the U.S., call **1-800-CHEV-USA**  
**(1-800-243-8872)**

In Canada, call **1-800-268-6800**

Service available 24 hours a day, 365 days a year.

As the owner of a new Chevrolet vehicle, you are automatically enrolled in the Chevrolet Roadside Assistance program. This value-added service is intended to provide you with peace of mind as you drive in the city or travel the open road.

### Who is Covered?

Roadside Assistance coverage is for the vehicle operator, regardless of ownership. A person driving this vehicle without the consent of the owner is not eligible for coverage.

The following services are provided in the U.S. during the Bumper-to-Bumper warranty period and, in Canada, during the Base Warranty coverage period of the New Vehicle Limited Warranty, up to a maximum coverage of \$100.

- **Fuel Delivery:** Delivery of enough fuel for the customer to get to the nearest service station (approximately \$5 in the U.S. and 10 litres in Canada). Service to provide diesel may be restricted. For safety reasons, propane and other alternative fuels will not be provided through this service.
- **Lock-out Service:** To ensure security, the driver must present the vehicle registration and personal ID before lock-out service is provided. Lock-out service will be covered at no charge if you are unable to gain entry into your vehicle. If your vehicle will not start, Roadside Assistance will arrange to have your vehicle towed to the nearest authorized dealership. In the U.S., replacement keys made at the customer's expense will be covered within 10 miles (16 km).

- **Emergency Tow From a Public Roadway or Highway:** Tow to the nearest dealership for warranty service or in the event of a vehicle-disabling accident. Winch-out assistance when the vehicle is mired in sand, mud, or snow.
- **Flat Tire Change:** If your vehicle has a spare tire, installation of the tire in good condition will be covered at no charge. The customer is responsible for the repair or replacement of the tire if not covered by a warrantable failure.
- **Jump Start:** No-start occurrences which require a battery jump start will be covered at no charge.

## **Additional Services for Canadian Customers**

- **Trip Routing Service:** Upon Request, Roadside Assistance will send you detailed, computer-personalized maps, highlighting your choice of either the most direct route or the most scenic route to your destination, anywhere in North America, along with any helpful travel information we may have pertaining to your trip. To request this service, please call us toll-free at 1-800-268-6800. We will make every attempt to send your personalized trip routing as quickly as possible, but it is best to allow three weeks before your planned departure date. Trip routing requests will be limited to six per calendar year.

- **Trip Interruption Benefits and Assistance:**

In the event of a warranty related vehicle disablement, while en route and over 250 kilometres from original point of departure, you may qualify for trip interruption expense assistance. This assistance covers reasonable reimbursement of up to a maximum of \$500 (Canadian) for (A) meals (maximum of \$50/day), (B) lodging (maximum of \$100/night) and (C) alternate ground transportation (maximum of \$40/day). This benefit is to assist you with some of the unplanned expense you may incur while waiting for your vehicle to be repaired.

Pre-authorization, original detailed receipts and a copy of the repair order are required.

Once authorization has been given, your advisor will help you make any necessary arrangements and explain how to claim for trip interruption expense assistance.

- **Alternative Service:** There may be times, when Roadside Assistance cannot provide timely assistance, your advisor may authorize you to secure local emergency road service, and you will be reimbursed up to \$100 upon submission of the original receipt to Roadside Assistance.

In many instances, mechanical failures are covered under Chevrolet's Bumper-to-Bumper warranty, and the duration of the Base Warranty Coverage for Canadian customers of the new Vehicle Limited Warranty. However, any cost for parts and labor for non-warranty repairs are the responsibility of the driver.

For prompt and efficient assistance when calling, please provide the following to the Roadside Assistance Representative:

- Your name, home address, and home telephone number.
- Telephone number of your location.
- Location of the vehicle.
- Model, year, color, and license plate number.
- Odometer reading, Vehicle Identification Number (VIN), and delivery date of the vehicle.
- Description of the problem.

While we hope you never have the occasion to use our service, it is added security while traveling for you and your family. Remember, we are only a phone call away. U.S. customers call Chevrolet Roadside Assistance: **1-800-CHEV-USA (1-800-243-8872)**, text telephone (TTY) users, call **1-888-889-2438**, Canadian customers call **1-800-268-6800**.



Chevrolet and General Motors of Canada Limited reserve the right to limit services or reimbursement to an owner or driver when, in their sole discretion, the claims become excessive in frequency or type of occurrence.

Roadside Assistance is not part of or included in the coverage provided by the New Vehicle Limited Warranty. Chevrolet and General Motors of Canada Limited reserve the right to make any changes or discontinue the Roadside Assistance program at any time without notification.

### **Towing and Road Service Exclusions**

Specifically excluded from Roadside Assistance coverage are towing or services for vehicles operated on a non-public roadway or highway, fines, impound towing caused by a violation of local, Municipal, State, Provincial, or Federal law, and mounting, dismounting or changing of snow tires, chains, or other traction devices.

## **Courtesy Transportation**

To enhance your ownership experience, we and our participating dealers are proud to offer Courtesy Transportation, a customer support program for new vehicles.

For warranty repairs during the Bumper-to-Bumper (U.S.) or Base Warranty Coverage period (Canada), provided by the New Vehicle Limited Warranty, interim transportation may be available under the Courtesy Transportation program. Several courtesy transportation options are available to assist in reducing your inconvenience when warranty repairs are required.

Courtesy Transportation is not a part of the New Vehicle Limited Warranty and is available only at participating dealers. A separate booklet entitled "Warranty and Owner Assistance Information" furnished with each new vehicle provides detailed warranty coverage information.

## Scheduling Service Appointments

When your vehicle requires warranty service, you should contact your dealer and request an appointment. By scheduling a service appointment and advising your service consultant of your transportation needs, your dealer can help minimize your inconvenience.

If your vehicle cannot be scheduled into the service department immediately, keep driving it until it can be scheduled for service, unless, of course, the problem is safety-related. If it is, please call your dealership, let them know this, and ask for instructions.

If the dealer requests that you simply drop the vehicle off for service, you are urged to do so as early in the work day as possible to allow for the same day repair.

## Transportation Options

Warranty service can generally be completed while you wait. However, if you are unable to wait, GM helps to minimize your inconvenience by providing several transportation options. Depending on the circumstances, your dealer can offer you one of the following:

### Shuttle Service

Shuttle service is the preferred means of offering Courtesy Transportation and participating dealers can provide you with shuttle service to get you to your destination with minimal interruption of your daily schedule. This includes one-way or round trip shuttle service within reasonable time and distance parameters for the dealer's area.

### Public Transportation or Fuel Reimbursement

If your vehicle requires overnight warranty repairs, and public transportation is used as 'shuttle service,' the reimbursement is limited to the associated shuttle allowance and must be supported by original receipts.

In addition, for U.S. customers, should you arrange transportation through a friend or relative, limited reimbursement for reasonable fuel expenses may be available. Claim amounts should reflect actual costs and be supported by original receipts.

### **Courtesy Rental Vehicle**

Your dealer may arrange to provide you with a courtesy rental vehicle or reimburse you for a rental vehicle that you obtain if your vehicle is kept for an overnight warranty repair. Rental reimbursement will be limited and must be supported by original receipts. This requires that you sign and complete a rental agreement and meet state/provincial, local, and rental vehicle provider requirements. Requirements vary and may include minimum age requirements, insurance coverage, credit card, etc. You are responsible for fuel usage charges and may also be responsible for taxes, levies, usage fees, excessive mileage, or rental usage beyond the completion of the repair.

Generally it is not possible to provide a like-vehicle as a courtesy rental.

### **Additional Program Information**

All program options, such as shuttle service, may not be available at every dealer. Please contact your dealer for specific information about availability. All Courtesy Transportation arrangements will be administered by appropriate dealer personnel.

*General Motors reserves the right to unilaterally modify, change or discontinue Courtesy Transportation at any time and to resolve all questions of claim eligibility pursuant to the terms and conditions described herein at its sole discretion.*

## Vehicle Data Collection and Event Data Recorders

Your vehicle, like other modern motor vehicles, has a number of sophisticated computer systems that monitor and control several aspects of the vehicle's performance. Your vehicle uses on-board vehicle computers to monitor emission control components to optimize fuel economy, to monitor conditions for airbag deployment and, if so equipped, to provide anti-lock braking and to help the driver control the vehicle in difficult driving situations. Some information may be stored during regular operations to facilitate repair of detected malfunctions; other information is stored only in a crash event by computer systems, such as those commonly called Event Data Recorders (EDR).

In a crash event, computer systems, such as the airbag Sensing and Diagnostic Module (SDM) in your vehicle may record information about the condition of the vehicle and how it was operated, such as data related to engine speed, brake application, throttle position, vehicle speed, safety belt usage, airbag readiness, airbag performance, and the severity of a collision. If your vehicle is

equipped with StabiliTrak<sup>®</sup>, steering performance, including yaw rate, steering wheel angle, and lateral acceleration, is also recorded. This information has been used to improve vehicle crash performance and may be used to improve crash performance of future vehicles and driving safety. Unlike the data recorders on many airplanes, these on-board systems do not record sounds, such as conversation of vehicle occupants.

To read this information, special equipment is needed and access to the vehicle or the device that stores the data is required. GM will not access information about a crash event or share it with others other than:

- with the consent of the vehicle owner or, if the vehicle is leased, with the consent of the lessee,
- in response to an official request of police or similar government office,
- as part of GM's defense of litigation through the discovery process, or
- as required by law.

In addition, once GM collects or receives data, GM may:

- use the data for GM research needs,
- make it available for research where appropriate confidentiality is to be maintained and need is shown, or
- share summary data which is not tied to a specific vehicle with non-GM organizations for research purposes.

Others, such as law enforcement, may have access to the special equipment that can read the information if they have access to the vehicle or the device that stores the data.

If your vehicle has OnStar<sup>®</sup>, please check the OnStar<sup>®</sup> subscription service agreement or manual for information on its operations and data collection.

## Collision Damage Repair

If your vehicle is involved in a collision and it is damaged, have the damage repaired by a qualified technician using the proper equipment and quality replacement parts. Poorly performed collision repairs will diminish your vehicle's resale value, and safety performance can be compromised in subsequent collisions.

## Collision Parts

Genuine GM Collision parts are new parts made with the same materials and construction methods as the parts with which your vehicle was originally built. Genuine GM Collision parts are your best choice to assure that your vehicle's designed appearance, durability, and safety are preserved. The use of Genuine GM parts can help maintain your GM New Vehicle Warranty.

Recycled original equipment parts may also be used for repair. These parts are typically removed from vehicles that were total losses in prior accidents. In most cases, the parts being recycled are from undamaged sections of the vehicle. A recycled original equipment GM part, may be an acceptable choice to maintain your vehicle's originally designed appearance and safety performance, however, the history of these parts is not known. Such parts are not covered by your GM New Vehicle Limited Warranty, and any related failures are not covered by that warranty.

Aftermarket collision parts are also available. These are made by companies other than GM and may not have been tested for your vehicle. As a result, these parts may fit poorly, exhibit premature durability/corrosion problems, and may not perform properly in subsequent collisions. Aftermarket parts are not covered by your GM New Vehicle Limited Warranty, and any vehicle failure related to such parts are not covered by that warranty.

## **Repair Facility**

GM also recommends that you choose a collision repair facility that meets your needs before you ever need collision repairs. Your GM dealer may have a collision repair center with GM-trained technicians and state of the art equipment, or be able to recommend a collision repair center that has GM-trained technicians and comparable equipment.

## **Insuring Your Vehicle**

Protect your investment in your GM vehicle with comprehensive and collision insurance coverage. There are significant differences in the quality of coverage afforded by various insurance policy terms. Many insurance policies provide reduced protection to your GM vehicle by limiting compensation for damage repairs by using aftermarket collision parts. Some insurance companies will not specify aftermarket collision parts. When purchasing insurance, we recommend that you assure your vehicle will be repaired with GM original equipment collision parts. If such insurance coverage is not available from your current insurance carrier, consider switching to another insurance carrier.

If your vehicle is leased, the leasing company may require you to have insurance that assures repairs with Genuine GM Original Equipment Manufacturer (OEM) parts or Genuine Manufacturer replacement parts. Read your lease carefully, as you may be charged at the end of your lease for poor quality repairs.

## If an Accident Occurs

Here is what to do if you are involved in an accident.

- Try to relax and then check to make sure you are all right. If you are uninjured, make sure that no one else in your vehicle, or the other vehicle, is injured.
- If there has been an injury, call 911 for help. Do not leave the scene of an accident until all matters have been taken care of. Move your vehicle only if its position puts you in danger or you are instructed to move it by a police officer.
- Give only the necessary and requested information to police and other parties involved in the accident. Do not discuss your personal condition, mental frame of mind, or anything unrelated to the accident. This will help guard against post-accident legal action.
- If you need roadside assistance, call GM Roadside Assistance. See *Roadside Assistance Program on page 542* for more information.
- If your vehicle cannot be driven, know where the towing service will be taking it. Get a card from the tow truck operator or write down the driver's name, the service's name, and the phone number.
- Remove any valuables from your vehicle before it is towed away. Make sure this includes your insurance information and registration if you keep these items in your vehicle.

- Gather the important information you will need from the other driver. Things like name, address, phone number, driver's license number, vehicle license plate, vehicle make, model and model year, Vehicle Identification Number (VIN), insurance company and policy number, and a general description of the damage to the other vehicle.
- If possible, call your insurance company from the scene of the accident. They will walk you through the information they will need. If they ask for a police report, phone or go to the police department headquarters the next day and you can get a copy of the report for a nominal fee. In some states/provinces with "no fault" insurance laws, a report may not be necessary. This is especially true if there are no injuries and both vehicles are driveable.
- Choose a reputable collision repair facility for your vehicle. Whether you select a GM dealer or a private collision repair facility to fix the damage, make sure you are comfortable with them. Remember, you will have to feel comfortable with their work for a long time.
- Once you have an estimate, read it carefully and make sure you understand what work will be performed on your vehicle. If you have a question, ask for an explanation. Reputable shops welcome this opportunity.



## Managing the Vehicle Damage Repair Process

In the event that your vehicle requires damage repairs, GM recommends that you take an active role in its repair. If you have a pre-determined repair facility of choice, take your vehicle there, or have it towed there. Specify to the facility that any required replacement collision parts be original equipment parts, either new Genuine GM parts or recycled original GM parts. Remember, recycled parts will not be covered by your GM vehicle warranty.

Insurance pays the bill for the repair, but you must live with the repair. Depending on your policy limits, your insurance company may initially value the repair using aftermarket parts. Discuss this with your repair professional, and insist on Genuine GM parts.

Remember if your vehicle is leased you may be obligated to have the vehicle repaired with Genuine GM parts, even if your insurance coverage does not pay the full cost.

If another party's insurance company is paying for the repairs, you are not obligated to accept a repair valuation based on that insurance company's collision policy repair limits, as you have no contractual limits with that company. In such cases, you can have control of the repair and parts choices as long as cost stays within reasonable limits.

## Reporting Safety Defects

### Reporting Safety Defects to the United States Government

If you believe that your vehicle has a defect which could cause a crash or could cause injury or death, you should immediately inform the National Highway Traffic Safety Administration (NHTSA), in addition to notifying General Motors.

If NHTSA receives similar complaints, it may open an investigation, and if it finds that a safety defect exists in a group of vehicles, it may order a recall and remedy campaign. However, NHTSA cannot become involved in individual problems between you, your dealer, or General Motors.

To contact NHTSA, you may call the Vehicle Safety Hotline toll-free at 1-888-327-4236 (TTY: 1-800-424-9153); go to <http://www.safercar.gov>; or write to:

Administrator, NHTSA  
400 Seventh Street, SW.  
Washington, D.C. 20590

You can also obtain other information about motor vehicle safety from <http://www.safercar.gov>.

### Reporting Safety Defects to the Canadian Government

If you live in Canada, and you believe that your vehicle has a safety defect, you should immediately notify Transport Canada, in addition to notifying General Motors of Canada Limited. You may call them at 1-800-333-0510 or write to:

Transport Canada  
Road Safety Branch  
2780 Sheffield Road  
Ottawa, Ontario K1B 3V9

### Reporting Safety Defects to General Motors

In addition to notifying NHTSA (or Transport Canada) in a situation like this, we certainly hope you will notify General Motors. Please call the Chevrolet Customer Assistance Center at 1-800-222-1020, or write:

Chevrolet Motor Division  
Chevrolet Customer Assistance Center  
P.O. Box 33170  
Detroit, MI 48232-5170

In Canada, please call us at 1-800-263-3777 (English) or 1-800-263-7854 (French). Or, write:

General Motors of Canada Limited  
Customer Communication Centre, CA1-163-005  
1908 Colonel Sam Drive  
Oshawa, Ontario L1H 8P7

## **Service Publications Ordering Information**

### **Service Manuals**

Service Manuals have the diagnosis and repair information on engines, transmission, axle suspension, brakes, electrical, steering, body, etc.

### **Transmission, Transaxle, Transfer Case Unit Repair Manual**

This manual provides information on unit repair service procedures, adjustments, and specifications for GM transmissions, transaxles, and transfer cases.

## **Service Bulletins**

Service Bulletins give technical service information needed to knowledgeably service General Motors cars and trucks. Each bulletin contains instructions to assist in the diagnosis and service of your vehicle.

In Canada, the service bulletin reference number can be obtained by contacting your General Motors dealer or by calling 1-800-GM-DRIVE (1-800-463-7483). This reference number is needed to order the service bulletin from Helm, Inc.

RETAIL SELL PRICE: \$6.00 US + Processing Fee

## Owner Information

Owner publications are written specifically for owners and intended to provide basic operational information about the vehicle. The owner manual will include the Maintenance Schedule for all models.

In-Portfolio: Includes a Portfolio, Owner Manual, and Warranty Booklet.

RETAIL SELL PRICE:  
\$35.00 US + Processing Fee

Without Portfolio: Owner's Manual only.

RETAIL SELL PRICE:  
\$25.00 US + Processing Fee

## Current and Past Model Order Forms

Technical Service Bulletins and Manuals are available for current and past model GM vehicles. To request an order form, please specify year and model name of the vehicle.

## ORDER TOLL FREE: 1-800-551-4123 Monday-Friday 8:00 AM - 6:00 PM Eastern Time

For Credit Card Orders Only  
(VISA-MasterCard-Discover), visit Helm, Inc. on  
the World Wide Web at: [www.helminc.com](http://www.helminc.com)

Or you can write to:

Helm, Incorporated  
P.O. Box 07130  
Detroit, MI 48207

Prices are subject to change without notice and without incurring obligation. Allow ample time for delivery.

Note to Canadian Customers: All listed prices are quoted in U.S. funds. Canadian residents are to make checks payable in U.S. funds.

# A

Accessories and Modifications .....	382
Accessory Inflator .....	469
Accessory Power Outlet(s) .....	183
Adding a Snow Plow or Similar Equipment .....	355
Adding Equipment to Your Airbag-Equipped Vehicle .....	89
Additives, Fuel .....	385
Add-On Electrical Equipment .....	500
Adjustable Throttle and Brake Pedal .....	116
Air Cleaner/Filter, Engine .....	406
Air Conditioning .....	185, 188
Air Suspension .....	361
Airbag	
Passenger Status Indicator .....	200
Readiness Light .....	199
Airbag Sensing and Diagnostic Module (SDM) .....	548
Airbag System .....	71
Adding Equipment to Your Airbag-Equipped Vehicle .....	89
How Does an Airbag Restrain? .....	79
Passenger Sensing System .....	82
Servicing Your Airbag-Equipped Vehicle .....	88
What Makes an Airbag Inflate? .....	79

Airbag System (cont.)	
What Will You See After an Airbag Inflates? .....	80
When Should an Airbag Inflate? .....	77
Where Are the Airbags? .....	74
All-Wheel Drive .....	434
All-Wheel-Drive (AWD) System .....	311
Antenna, Fixed Mast .....	296
Antenna, XM™ Satellite Radio Antenna System .....	297
Anti-Lock Brake System (ABS) .....	305
Anti-Lock Brake, System Warning Light .....	205
Appearance Care	
Aluminum Wheels .....	495
Care of Safety Belts .....	493
Chemical Paint Spotting .....	497
Cleaning Exterior Lamps/Lenses .....	494
Cleaning the Inside of Your Vehicle .....	489
Fabric/Carpet .....	491
Finish Care .....	494
Finish Damage .....	496
Instrument Panel, Vinyl, and Other Plastic Surfaces .....	492
Leather .....	492
Sheet Metal Damage .....	496
Tires .....	496
Underbody Maintenance .....	497

Appearance Care (cont.)	
Vehicle Care/Appearance Materials .....	498
Washing Your Vehicle .....	493
Weatherstrips .....	493
Windshield, Backglass, and Wiper Blades .....	495
Ashtray(s) .....	184
Audio System(s) .....	234
Audio Steering Wheel Controls .....	294
Care of Your CD and DVD Player .....	296
Care of Your CDs and DVDs .....	296
Chime Level Adjustment .....	297
Fixed Mast Antenna .....	296
Navigation/Radio System, see Navigation Manual .....	277
Radio with CD .....	236, 246
Radio with Six-Disc CD .....	255
Rear Seat Audio (RSA) .....	292
Setting the Time .....	236
Theft-Deterrent Feature .....	293
Understanding Radio Reception .....	295
XM™ Satellite Radio Antenna System .....	297
Automatic Headlamp System .....	179
Automatic Transmission	
Fluid .....	407
Operation .....	118

## B

Battery .....	428
Electric Power Management .....	182
Run-Down Protection .....	183
Before Leaving on a Long Trip .....	340
Brake	
Anti-Lock Brake System (ABS) .....	305
Emergencies .....	307
Parking .....	126
System Warning Light .....	204
Brake Pedal, Throttle .....	116
Brakes .....	424
Braking .....	304
Braking in Emergencies .....	307
Break-In, New Vehicle .....	112
Bulb Replacement .....	437
Halogen Bulbs .....	437
License Plate Lamps .....	439
Replacement Bulbs .....	439
Taillamps and Turn Signal Lamps .....	438
Buying New Tires .....	462

## C

Calibration .....	133, 135, 138, 140
California Fuel .....	385
California Proposition 65 Warning .....	383
Canadian Owners .....	3
Capacities and Specifications .....	510
Carbon Monoxide .....	106, 130, 344, 363
Care of	
Safety Belts .....	493
Your CD and DVD Player .....	296
Your CDs and DVDs .....	296
Cargo Cover .....	163
Cargo Tie Downs .....	164
CD, MP3 .....	268
Center Console Storage Area .....	160
Chains, Tire .....	468
Charging System Light .....	203
Check	
Engine Light .....	208
Gages Warning Light .....	214
Check Gas Cap Light .....	215
Checking Things Under the Hood .....	390
Chemical Paint Spotting .....	497

Child Restraints	
Child Restraint Systems .....	49
Infants and Young Children .....	45
Lower Anchors and Tethers for Children .....	56
Older Children .....	42
Securing a Child Restraint in a Rear	
Outside Seat Position .....	63
Securing a Child Restraint in the Center	
Rear Seat Position .....	66
Securing a Child Restraint in the Right	
Front Seat Position .....	66
Where to Put the Restraint .....	54
Chime Level Adjustment .....	297
Cigarette Lighter .....	184
Cleaning	
Aluminum Wheels .....	495
Exterior Lamps/Lenses .....	494
Fabric/Carpet .....	491
Finish Care .....	494
Inside of Your Vehicle .....	489
Instrument Panel, Vinyl, and Other Plastic	
Surfaces .....	492
Leather .....	492
Tires .....	496





Door	
Delayed Locking .....	102
Locks .....	100
Power Door Locks .....	101
Programmable Automatic Door Locks .....	102
Rear Door Security Locks .....	105
Driver	
Position, Safety Belt .....	26
Driver Information Center (DIC) .....	216
DIC Operation and Displays .....	217
DIC Vehicle Customization .....	226
DIC Warnings and Messages .....	220
Driving	
At Night .....	333
City .....	338
Defensive .....	300
Drunken .....	301
Freeway .....	339
Hill and Mountain Roads .....	342
In Rain and on Wet Roads .....	334
Off-Road .....	317
Recovery Hooks .....	349
Rocking Your Vehicle to Get it Out .....	348
Winter .....	344

Dual Automatic Climate Control System .....	188
Dual Climate Control System .....	185
DVD	
Rear Seat Entertainment System .....	277

## E

Electric Power Management .....	182
Electrical System	
Add-On Equipment .....	500
Engine Compartment Fuse Block .....	501
Fuses and Circuit Breakers .....	501
Headlamps .....	500
Power Windows and Other Power	
Options .....	500
Rear Underseat Fuse Block .....	507
Windshield Wiper Fuses .....	500
Electronically Controlled Air Suspension	
System .....	361
Engine	
Air Cleaner/Filter .....	406
Battery .....	428
Change Engine Oil Light .....	212
Check and Service Engine Soon Light .....	208

Engine (cont.)	
Coolant .....	411
Coolant Heater .....	116
Coolant Temperature Gage .....	207
Drive Belt Routing .....	531
Engine Compartment Overview .....	392
Exhaust .....	130
Fan Noise .....	422
Oil .....	398
Oil Life System .....	404
Overheating .....	414
Reduced Power Light .....	213
Starting .....	114
Entry Lighting .....	182
Event Data Recorders (EDR) .....	548
Exit Lighting .....	182
Extender, Safety Belt .....	41

## F

Filter	
Engine Air Cleaner .....	406
Finish Damage .....	496
Fixed Mast Antenna .....	296
Flashers, Hazard Warning .....	170
Flash-to-Pass .....	172

Flat Tire .....	471
Flat Tire, Changing .....	472
Flat Tire, Storing .....	486
Fluid	
Automatic Transmission .....	407
Power Steering .....	422
Windshield Washer .....	423
Fog Lamps .....	180
Four-Wheel Drive .....	122, 435
Front Axle .....	436
Fuel .....	384
Additives .....	385
California Fuel .....	385
Check Gas Cap Light .....	215
Filling a Portable Fuel Container .....	389
Filling Your Tank .....	387
Fuels in Foreign Countries .....	386
Gage .....	215
Gasoline Octane .....	384
Gasoline Specifications .....	385
Low Warning Light .....	215
Fuses	
Engine Compartment Fuse Block .....	501
Fuses and Circuit Breakers .....	501
Rear Underseat Fuse Block .....	507
Windshield Wiper .....	500

## G

Gage	
Check Gages Warning Light .....	214
Engine Coolant Temperature .....	207
Fuel .....	215
Oil Pressure .....	211
Speedometer .....	197
Tachometer .....	197
Voltmeter Gage .....	203
Garage Door Opener .....	149
Gasoline	
Octane .....	384
Specifications .....	385
Gate Ajar Light .....	214
Glove Box .....	160
GM Mobility Reimbursement Program .....	541

## H

Hazard Warning Flashers .....	170
Head Restraints .....	17
Headlamps .....	178
Automatic Headlamp System .....	179
Bulb Replacement .....	437
Daytime Running Lamps .....	179
Electrical System .....	500
Flash-to-Pass .....	172
Halogen Bulbs .....	437
High/Low Beam Changer .....	172
On Reminder .....	178
Heated Seats .....	11
Heater .....	185
Heater .....	188
Highbeam On Light .....	213
High-Speed Operation, Tires .....	454
Highway Hypnosis .....	341
Hill and Mountain Roads .....	342
Hood	
Checking Things Under .....	390
Release .....	390
Horn .....	170
How to Use This Manual .....	4
How to Wear Safety Belts Properly .....	26

## I

Ignition Positions .....	113
Infants and Young Children, Restraints .....	45
Inflation - Tire Pressure .....	452
Instrument Panel	
Overview .....	168
Instrument Panel (I/P)	
Brightness .....	181
Cluster .....	196

## J

Jump Starting .....	429
---------------------	-----

## K

Keyless Entry System .....	96
Keys .....	95

## L

Labeling, Tire Sidewall .....	445
Lamps	
Battery Run-Down Protection .....	183
Dome .....	181
Dome Lamp Override .....	181
Electric Power Management .....	182
Fog .....	180
Reading .....	182
LATCH System	
Child Restraints .....	56
License Plate Lamps .....	439
Liftgate/Liftglass .....	106
Liftglass/Liftgate .....	106
Light	
Airbag Readiness .....	199
Anti-Lock Brake System Warning .....	205
Brake System Warning .....	204
Change Engine Oil .....	212
Charging System .....	203
Check Gages Warning .....	214
Check Gas Cap .....	215
Cruise Control .....	213



Manual Seats .....	8
Memory Seat, Mirrors, and Pedals .....	11
Message	
DIC Warnings and Messages .....	220
Mirrors	
Automatic Dimming Rearview with Compass .....	138
Automatic Dimming Rearview with Compass and Temperature Display .....	140
Automatic Dimming Rearview with OnStar® and Compass .....	133
Automatic Dimming Rearview with OnStar®, Compass and Temperature Display .....	135
Manual Rearview Mirror .....	132
Manual Rearview Mirror with OnStar® .....	132
Outside Convex Mirror .....	144
Outside Curb View Assist Mirror .....	144
Outside Heated Mirrors .....	145
Outside Manual Mirrors .....	143
Outside Power Mirrors .....	143
MP3 .....	268
MyGMLink.com .....	539

## N

Navigation/Radio System, see Navigation	
Manual .....	277
New Vehicle Break-In .....	112
Normal Maintenance Replacement Parts .....	530

## O

Odometer .....	197
Odometer, Trip .....	197
Off-Road Driving .....	317
Off-Road Recovery .....	314
Oil	
Change Engine Oil Light .....	212
Engine .....	398
Pressure Gage .....	211
Oil, Engine Oil Life System .....	404
Older Children, Restraints .....	42
Online Owner Center .....	539
OnStar® System, see OnStar® Manual .....	145
Other Warning Devices .....	170
Outlet Adjustment .....	192

Outlet(s), Accessory Power .....	183
Outside	
Convex Mirror .....	144
Curb View Assist Mirror .....	144
Heated Mirrors .....	145
Manual Mirrors .....	143
Power Mirrors .....	143
Overhead Console .....	160
Owner Checks and Services .....	523
Owners, Canadian .....	3

## P

Paint, Damage .....	496
Park (P)	
Shifting Into .....	127
Shifting Out of .....	129
Parking	
Brake .....	126
Over Things That Burn .....	129
Passenger Airbag Status Indicator .....	200
Passenger Sensing System .....	82

Passing .....	314
Passlock® .....	111
Power	
Accessory Outlet(s) .....	183
Door Locks .....	101
Electrical System .....	500
Lumbar Controls .....	10
Reduced Engine Light .....	213
Retained Accessory (RAP) .....	114
Seat .....	9
Steering Fluid .....	422
Windows .....	108
Pretensioners, Safety Belt .....	41
Programmable Automatic Door Locks .....	102

## Q

Questions and Answers About	
Safety Belts .....	25

# R

Radiator Pressure Cap .....	414	Rear Windshield Washer/Wiper .....	174
Radios .....	234	Rearview Mirror, Automatic Dimming with Compass .....	138
Care of Your CD and DVD Player .....	296	Rearview Mirror, Automatic Dimming with Compass and Temperature Display .....	140
Care of Your CDs and DVDs .....	296	Rearview Mirror, Automatic Dimming with OnStar® and Compass .....	133
Navigation/Radio System, see Navigation Manual .....	277	Rearview Mirror, Automatic Dimming with OnStar®, Compass and Temperature Display .....	135
Radio with CD .....	236, 246	Rearview Mirror with OnStar® .....	132
Radio with Six-Disc CD .....	255	Rearview Mirrors .....	132
Rear Seat Audio .....	292	Reclining Seatbacks .....	14
Setting the Time .....	236	Recommended Fluids and Lubricants .....	527
Theft-Deterrent .....	293	Recovery Hooks .....	349
Understanding Reception .....	295	Recreational Vehicle Towing .....	356
Reading Lamps .....	182	Reduced Engine Power Light .....	213
Rear Axle .....	434	Remote Keyless Entry (RKE) System .....	96
Locking .....	307	Remote Keyless Entry (RKE) System, Operation .....	98
Rear Climate Control System .....	193	Removing the Flat Tire and Installing the Spare Tire .....	477
Rear Door Security Locks .....	105	Removing the Spare Tire and Tools .....	473
Rear Floor Storage Lid .....	162	Replacement Bulbs .....	439
Rear Safety Belt Comfort Guides .....	38		
Rear Seat Audio (RSA) .....	292		
Rear Seat Entertainment System .....	277		
Rear Seat Operation .....	18		
Rear Seat Passengers, Safety Belts .....	35		



Reporting Safety Defects	
Canadian Government .....	554
General Motors .....	554
United States Government .....	554
Restraint System Check	
Checking the Restraint Systems .....	90
Replacing Restraint System Parts	
After a Crash .....	91
Retained Accessory Power (RAP) .....	114
Right Front Passenger Position,	
Safety Belts .....	35
Roadside	
Assistance Program .....	542
Rocking Your Vehicle to Get it Out .....	348
Routing, Engine Drive Belt .....	531
Running the Engine While Parked .....	131

## S

Safety Belt	
Passenger Reminder Light .....	198
Pretensioners .....	41
Reminder Light .....	198
Safety Belts	
Care of .....	493
Driver Position .....	26
How to Wear Safety Belts Properly .....	26

Safety Belts (cont.)	
Questions and Answers About	
Safety Belts .....	25
Rear Safety Belt Comfort Guides .....	38
Rear Seat Passengers .....	35
Right Front Passenger Position .....	35
Safety Belt Extender .....	41
Safety Belt Use During Pregnancy .....	34
Safety Belts Are for Everyone .....	20
Safety Warnings and Symbols .....	4
Scheduled Maintenance .....	517
Seats	
Head Restraints .....	17
Heated Seats .....	11
Manual .....	8
Manual Lumbar .....	10
Memory, Mirrors and Pedals .....	11
Power Lumbar .....	10
Power Seats .....	9
Rear Seat Operation .....	18
Reclining Seatbacks .....	14
Secondary Latch System .....	482
Securing a Child Restraint	
Center Rear Seat Position .....	66
Rear Outside Seat Position .....	63
Right Front Seat Position .....	66
Security Light .....	212

Service .....	382	Steering .....	312
Accessories and Modifications .....	382	Steering Wheel Controls, Audio .....	294
Adding Equipment to the Outside of Your Vehicle .....	384	Steering Wheel, Tilt Wheel .....	170
California Proposition 65 Warning .....	383	Storage Areas	
Doing Your Own Work .....	383	Center Console Storage Area .....	160
Engine Soon Light .....	208	Convenience Net .....	162
Four-Wheel-Drive Warning Light .....	214	Glove Box .....	160
Publications Ordering Information .....	555	Luggage Carrier .....	161
Servicing Your Airbag-Equipped Vehicle .....	88	Overhead Console .....	160
Setting the Time .....	236	Rear Floor Storage Lid .....	162
Sheet Metal Damage .....	496	Stuck in Sand, Mud, Ice, or Snow .....	348
Shifting Into Park (P) .....	127	Sun Visors .....	109
Shifting Out of Park (P) .....	129	Sunroof .....	164
Signals, Turn and Lane-Change .....	171	Suspension .....	361
Snow Plow .....	355		
Spare Tire .....	489	<b>T</b>	
Accessory Inflator .....	469	Tachometer .....	197
Installing .....	477	Taillamps	
Removing .....	473	Turn Signal Lamps .....	438
Storing .....	486	Theft-Deterrent, Radio .....	293
Specifications, Capacities .....	510	Theft-Deterrent Systems .....	109
Speedometer .....	197	Content Theft-Deterrent .....	110
StabiliTrak® System .....	307	Passlock® .....	111
StabiliTrak® Indicator Light .....	206	Throttle, Adjustable .....	116
StabiliTrak® Service Light .....	206	Tilt Wheel .....	170
Starting Your Engine .....	114		



## V

Vehicle	
Control .....	304
Damage Warnings .....	5
Loading .....	350
Symbols .....	5
Vehicle Customization, DIC .....	226
Vehicle Data Collection and Event Data	
Recorders .....	548
Vehicle Identification	
Number (VIN) .....	499
Service Parts Identification Label .....	499
Ventilation Adjustment .....	192
Visors .....	109
Voltmeter Gage .....	203

## W

Warning Lights, Gages and Indicators .....	195
Warnings	
DIC Warnings and Messages .....	220
Hazard Warning Flashers .....	170
Other Warning Devices .....	170
Safety and Symbols .....	4
Vehicle Damage .....	5

Wheels	
Alignment and Tire Balance .....	466
Different Size .....	464
Replacement .....	467
Where to Put the Restraint .....	54
Windows .....	107
Power .....	108
Windshield	
Backglass, and Wiper Blades, Cleaning ...	495
Washer .....	173
Washer Fluid .....	423
Wiper Blade Replacement .....	440
Wiper Fuses .....	500
Wipers .....	173
Windshield, Rear Washer/Wiper .....	174
Winter Driving .....	344
Winter Tires .....	444

## X

XM Radio Messages .....	274
XM™ Satellite Radio Antenna System .....	297

## Y

Your Vehicle and the Environment .....	515
--	-----